

Instruction Manual

TN-100/T-100

Portable Turbidimeter



OAKTON[®]



EUTECH
INSTRUMENTS
Technology Made Easy...

ISO 9001
CERTIFIED

68X357701 Rev. 4 Apr 06

Certificate of Compliance

This is to certify that the TN100 Portable Turbidimeter complies with the specifications established by the ISO 7027 International Standard for Water Quality - Determination of Turbidity, Section 3: Quantitative Methods using Optical Turbidimeters.



**EUTECH
INSTRUMENTS**

Technology Made Easy...

Preface

This manual functions in two ways: first as a step by step guide to help you operate the waterproof TN-100/ T-100 turbidimeter; second, it serves as a handy reference guide.

It contains basic instructions that you must follow during the operation, care and maintenance of the instrument. The safety protection provided by this equipment may be impaired if it is used in a manner not described in this manual. It is recommended that all operators should read this manual prior to working with this instrument.

Eutech Instruments/ Oakton Instruments cannot accept any responsibility for damage or malfunction to the meter caused by improper use of the instrument.

The information presented in this manual is subject to change without notice as improvements are made, and does not represent a commitment on the part of Eutech Instruments Pte Ltd/ Oakton Instruments.

Note: Eutech Instruments Pte Ltd/ Oakton Instruments reserves the right to make improvements in design, construction, and appearance of products without notice.

Copyright © 2006 All rights reserved.

Eutech Instruments Pte Ltd

Oakton Instruments

Table of Contents

1. Overview	1
1.1 Unpacking TN-100/ T-100 Meter and Accessories	1
1.2 Display	2
1.3 Keys and Functions	3
1.4 Battery Installation	4
2. Turbidity Calibration	5
2.1 Calibration Standards	5
2.2 Indexing	5
2.3 Calibration Procedure	6
2.4 Restoring Factory Calibration	8
3. Turbidity Measurement	10
3.1 General Information	10
3.2 Turbidity Measurement Procedure	10
3.3 Single-Shot or Continuous Measurement	13
4. Troubleshooting Guide	15
5. Routine Maintenance	16
5.1 Vials – Handling, Cleaning and Care	16
6. Accessories	17
7. Specifications	18
8. Addendum 1: Turbidity	19
8.1 Definition	19
8.2 Why Is It Important?	19
8.3 Measurement Principle	19
8.4 Nephelometric Turbidity Units (NTU)	20
8.5 Indexing a Vial	20
9. Addendum 2: Guide to Good Measurement Technique	21
9.1 Maintain sample vials in good condition	21
9.2 Match Sample Vials	21
9.3 Degassing	22
9.4 Timeliness of Sample	22
9.5 Other Important Sampling Techniques	22
9.6 Calibration	23
9.7 Dilution	23
10. Warranty	24
11. Return of Items	24

1. Overview

Thank you for selecting the waterproof portable TN-100/ T-100 turbidimeter. The TN-100/ T-100 allows you to measure turbidity of an aqueous sample in the field. This instrument operates on the nephelometric principle of turbidity measurement and is designed to meet the criteria specified in ISO 7027 and DIN 27027 standards (see Measurement Principle on page 19).

1.1 Unpacking TN-100/ T-100 Meter and Accessories

The table below indicates the items that you should find in your turbidimeter shipment.

Item	Quantity
1. Portable TN-100/ T-100 Turbidimeter with 4 “AAA” batteries	1
2. Instruction Manual	1
3. Instrument Carrying Case	1
4. Light Shield Cap	1
5. Calibration Set (0.02, 20.0, 100, 800 NTU Standards)	1
6. Empty Vials	3
7. Plastic bottle (empty – for collecting sample)	1
8. Silicone Oil	1
9. Lint free cloth	1

Remove TN-100/ T-100 turbidimeter from the packing carton. Carefully inspect all items to ensure that no visible damage has occurred during shipment. If the items you received do not match your order, please contact your nearest distributor immediately.

WARNING: *Extra care should be taken when unpacking, opening, and handling the calibration standards and sample vials. Surface scratches or finger smudges on the vial surface may cause measurement errors. Handle these items by their caps only.*

Batteries provided with the meter package are to be installed prior to use. See Section 1.4 - Battery Installation on page 4.

Figure 1 depicts the meter. The three main components of the instrument are the sample well, the display, and the keypad. The following sections describe the functionality of the display and the keypad. The proper use of the instrument and the sample well are discussed in later sections.

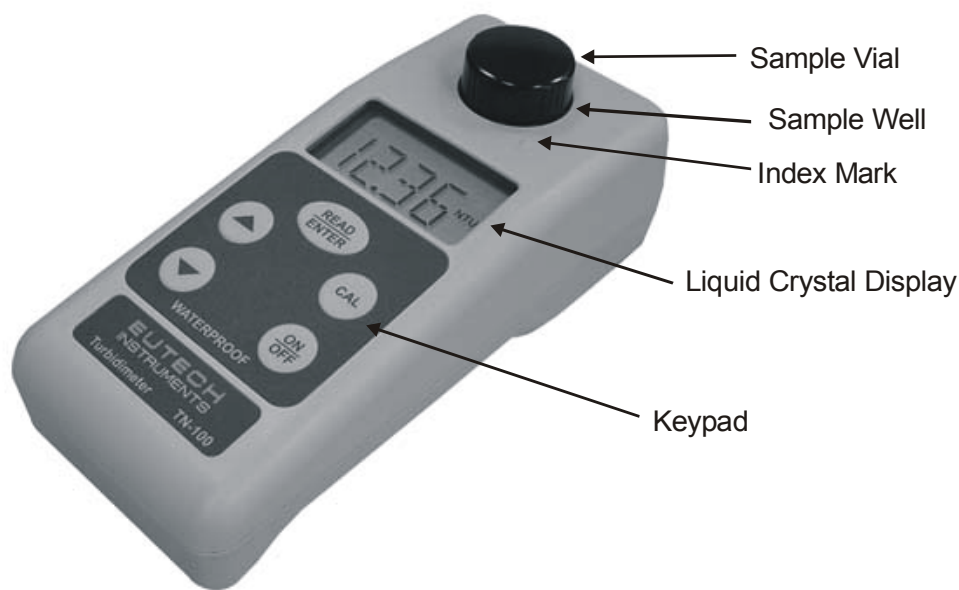

Figure 1: Parts of TN-100/T-100 Turbidimeter

1.2 Display

All the LCD segments and annunciators that can appear on the display are shown in Figure 2. The display is used for reporting the turbidity reading and to provide guidance for the operation of the instrument. In addition, the display has several other annunciators that are used to communicate error messages and provide user guidance.

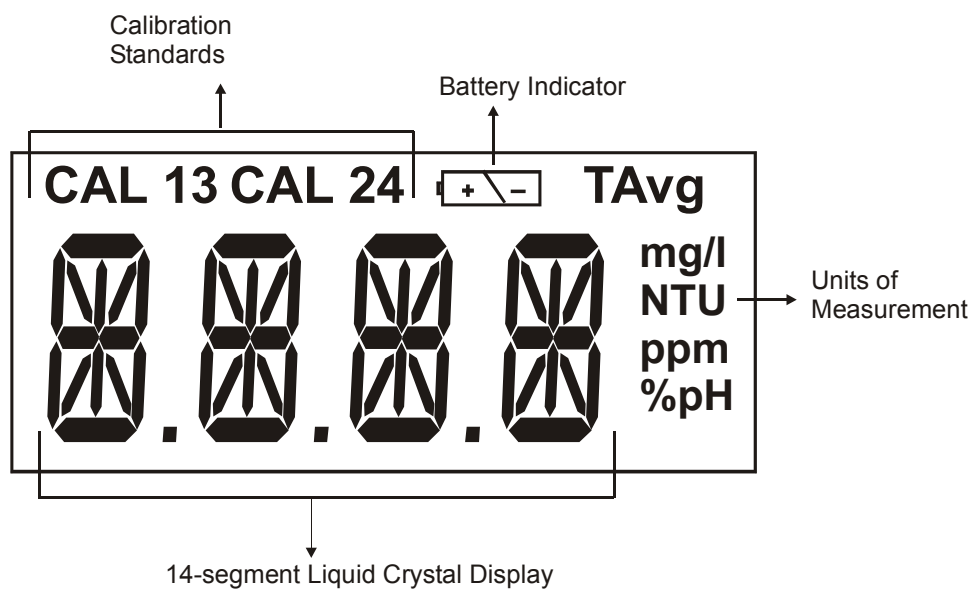







Figure 2: Customized LCD with all annunciators

1.3 Keys and Functions

The keypad has five keys: ON/OFF, CAL, ▲, ▼, and READ/ENTER.

Key	Functions
	Powers on and shuts off the meter. With the auto switch-off feature the meter automatically shuts off 20 minutes after last key press.
	Initiates the calibration mode of the meter. When pressed, the meter is set to accept the first calibration standard. It is also used to exit the calibration mode if the user does not want to follow the complete calibration procedure.
	When in measurement mode, the READ/ENTER key is used to perform a measurement. <i>Single-shot measurements:</i> When the key is pressed and released immediately (a quick key stroke of less than 0.3 seconds), the display will blink [-Rd-] for 10 times and then display the measured value. <i>Continuous measurements:</i> If the READ/ENTER key is pressed and held, the instrument will perform a continuous measurement during which the display is updated every 2 seconds. This can be used for indexing vials. (This function is not available in calibration mode). After the READ/ENTER key is released, the instrument will automatically perform a single-shot measurement.
 	Active only during calibration mode. These keys are used to select the calibration point in an incremental/ decremental manner. <i>NOTE: This meter is fitted with an auto incrementing feature, i.e. after the successful calibration of one point it auto selects the next calibration point, or automatically exits the calibration mode after the fourth calibration point.</i>

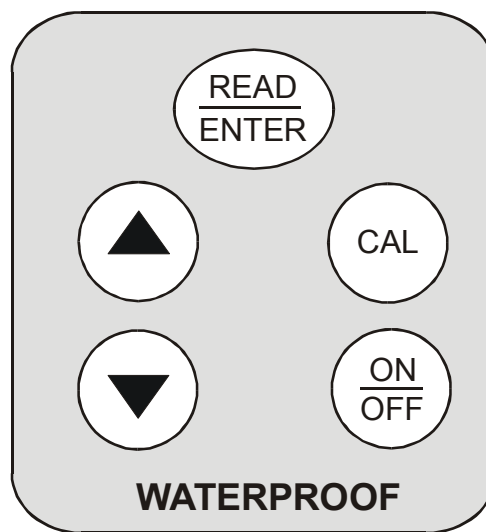

Figure 3: Keypad

1.4 Battery Installation

Four AAA-sized batteries are included in the packaging:

1. Use a Philips screwdriver to remove the two screws holding the battery cover. See Figure 4.
2. Remove the battery cover.
3. Insert the batteries. Follow the diagram inside the cover for correct polarity.
4. Replace the battery cover onto its original position using the two screws removed earlier.
5. The meter is now ready to operate.

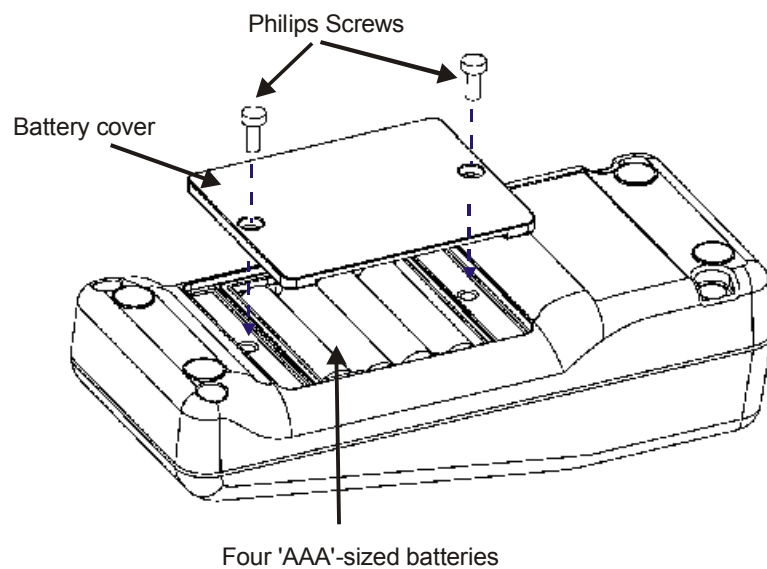

Figure 4: Battery Installation

NOTE: Dispose used batteries in accordance with your local regulations.

2. Turbidity Calibration

The TN-100/ T-100 turbidimeter was calibrated and tested prior to leaving the factory. Therefore, it is possible to use the instrument directly out of the box. However, re-calibration of the instrument is recommended to help you become familiar with the operation of the instrument and the calibration procedures. In addition, re-calibration is recommended at least once every month for optimum accuracy.

It is recommended that you perform a full calibration using all 4 standards provided to ensure full-range accuracy. However, the TN-100/ T-100 turbidimeter provides flexibility for you to calibrate at selected ranges suitable for your application.

In addition, the instrument comes with a light shield cap to shield off stray light during calibration and measurements.

2.1 Calibration Standards

We recommend that you use the following materials during calibration to achieve the accuracy stated in this manual:

- **CAL 1:** 800 NTU Calibration Standard
- **CAL 2:** 100 NTU Calibration Standard
- **CAL 3:** 20.0 NTU Calibration Standard
- **CAL 4:** 0.02 NTU Calibration Standard

It is well known that diluted Formazin is unstable. If you choose to use Formazin to calibrate the instrument, ensure that you are using a fresh stock suspension of Formazin to achieve the accuracy quoted for the instrument. Calibration standards offered are more stable than Formazin and have a limited shelf life of 12 months. If you use the supplied calibration standards to calibrate the instrument, review the expiration date (indicated on cap label) to ensure that the standards have not expired.

It is important that the calibration standards are not violently shaken or agitated because air entrapment in the fluid introduces an error factor during calibration which subsequently will lead to an inaccurate measurement. Also, do not store in freezing temperatures which causes irreversible shrinkage of the standards' particles thus resulting to inaccurate calibration and measurement.

2.2 Indexing

Due to the high quality of the glass vials provided, indexing is not required. You only need to align the mark on the vial with the mark on the meter. However, in order to achieve a better accuracy of the measurement, you can proceed with indexing of the vials. See Section 8.5 - Indexing a Vial on page 20 for more information.

2.3 Calibration Procedure

1. Place TN-100/ T-100 turbidimeter on a flat and level surface.
2. Insert the CAL 1 standard (800 NTU) into the sample well, aligning the mark on the vial with the mark on the meter. See **Figure 10** on page 12.
3. Press down vial until it snaps fully into the instrument.
4. Cover the vial using the light shield cap.
5. Press **ON/OFF** key to switch the on the meter. The meter goes to measurement mode after the power-up sequence.
6. Select the calibration function of the instrument by pressing the **CAL** key once. The “CAL” annunciator blinks momentarily and the meter prompt for the first calibration standard “CAL 1 800 NTU”.
7. Press **READ/ENTER** key.
8. The “CAL 1 800 NTU” annunciator blinks for about 12 seconds while the instrument performs calibration of CAL 1 point. When the instrument has completed calibration for this point, it prompts you to insert the next calibration standard into the sample well “CAL 2 100 NTU”.
9. Repeat the calibration for CAL 2, CAL 3 & CAL 4 calibration standards.
10. After you successfully calibrate the CAL 4 standard (0.02 NTU), the display shows “STbY”.
11. The meter is now ready for measurement.

Figure 5 shows the complete calibration sequence.

NOTES:

1. *If you wish to exit the calibration mode you may do so at the end of any step by pressing the **CAL** key. The meter accepts only the values calibrated prior to exiting.*
2. *You can skip a calibration point by pressing **▲** or **▼** keys and move on to the next calibration point.*
3. *After a successful calibration of one point, the meter automatically selects the next calibration point. The meter automatically exits calibration mode after the fourth calibration point.*
4. *If an error occurs during calibration, the display shows an error message. The meter aborts calibration and returns to the measurement mode without saving the last calibration value.*
5. *For a list of error messages, refer to Section 4: Troubleshooting Guide on page 15.*

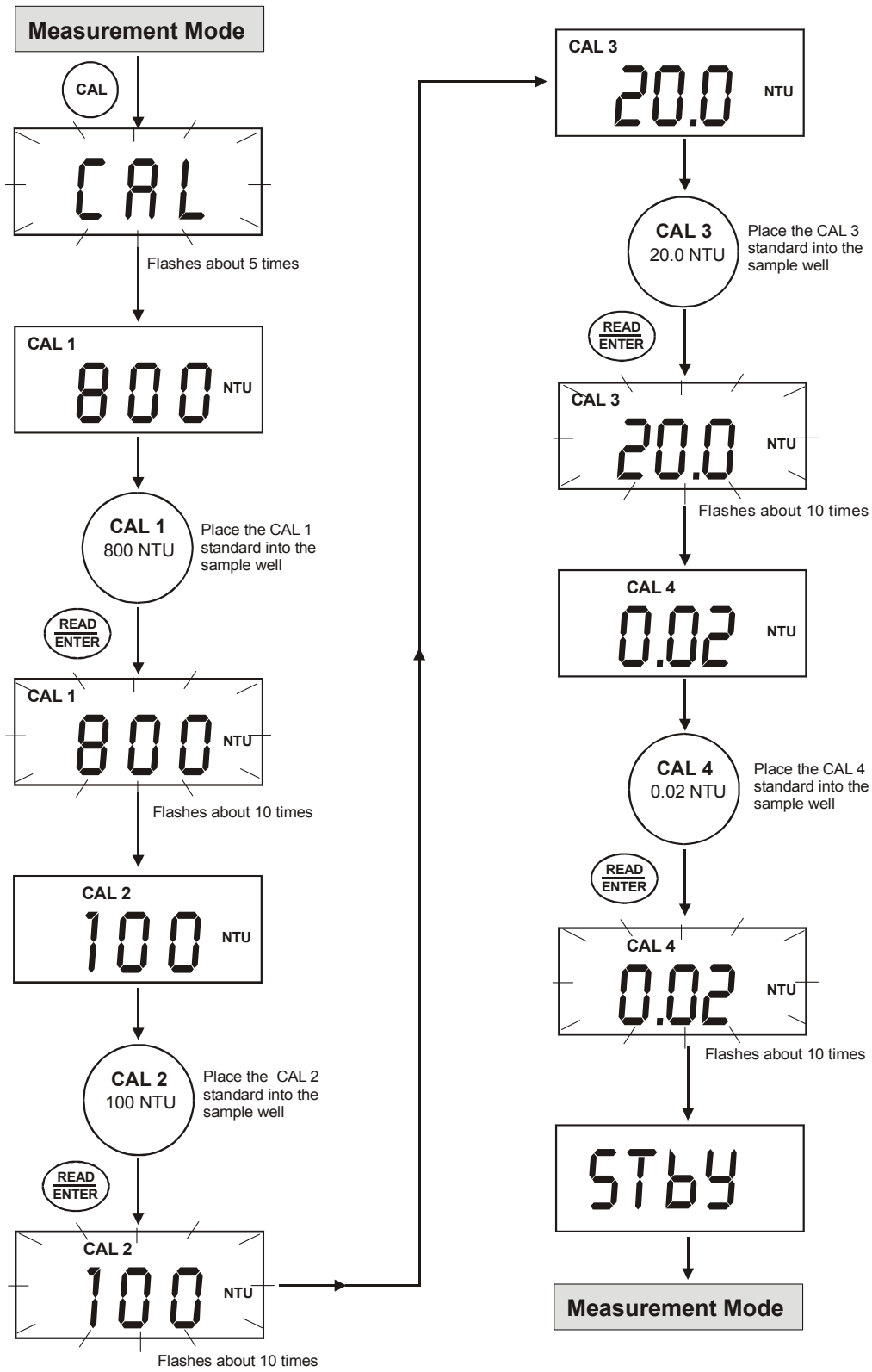

Figure 5: Calibration Sequence

2.4 Restoring Factory Calibration

The TN-100/ T-100 turbidimeter allows you to reset the meter back to the factory default calibration values. This feature is extremely useful when there are errors in calibration or when you have new calibration standards.

1. With the meter switched off, press and hold ▲ key.
2. Switch on the meter using **ON/OFF**. Release ▲ key when “URST” (User-Reset) appears in the display.
3. The display shows “URST” for about 2 seconds and then shows “No”.
4. Use ▲ or ▼ key to select between “YES” or “No”.
 - **YES** = To restore meter back to factory calibration values
 - **No** = To retain last calibrated values
5. Press **READ/ENTER** key to confirm your selection. The meter performs the reset if “YES” is selected.
6. The display flashes “--Rd—” about 10 times indicating that the meter goes to measurement mode.

Figure 6 shows the sequence for restoring factory calibration values.

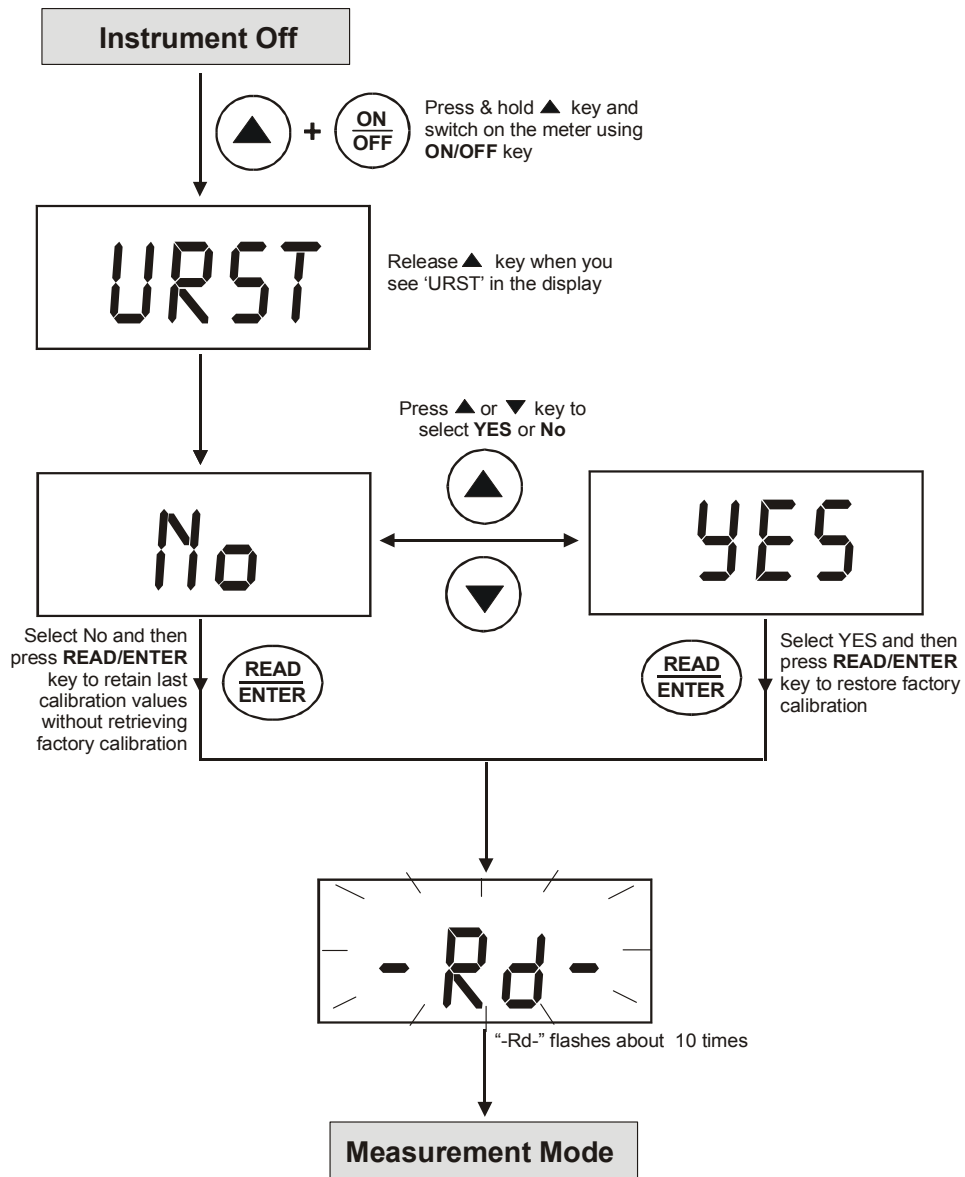

Figure 6: Restoring Factory Calibration

3. Turbidity Measurement

3.1 General Information

The waterproof TN-100/ T-100 turbidimeter allows you to measure the turbidity of a grab sample. The turbidity is reported in Nephelometric Turbidity Units (NTU). Readings above 1000 NTU are outside the range of this instrument.

NOTE: Before switching on the TN-100/ T-100 turbidimeter, a sample vial **MUST** be placed in the sample well. You can use any of the calibration standards for this purpose.

The light shield cap provided could be used to cover the vial during measurements.

When the **ON/FF** key is pressed to switch on the meter, it goes through the power-up sequence as shown in Figure 7 below.

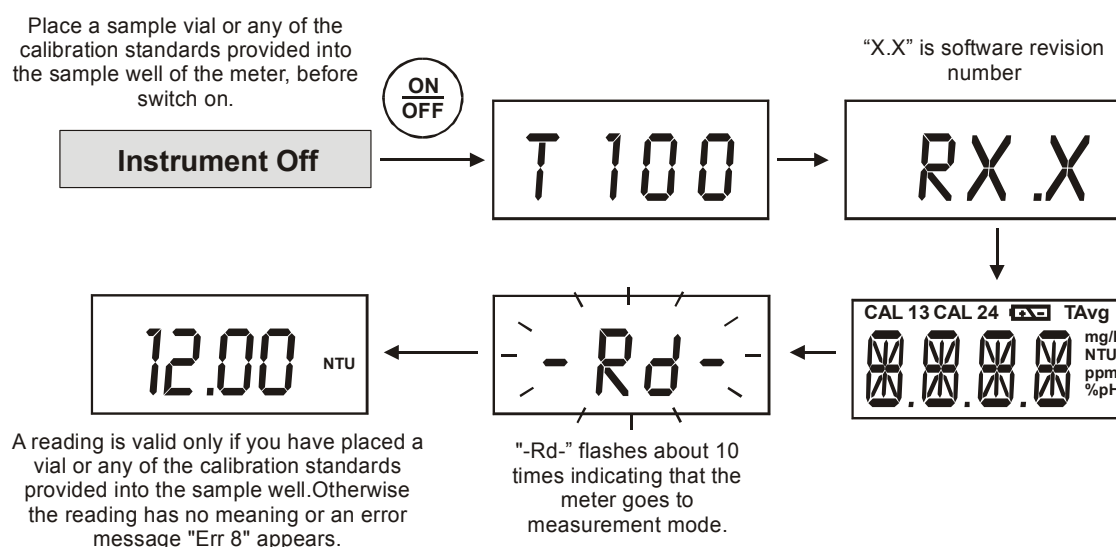

Figure 7: Power-up Sequence

3.2 Turbidity Measurement Procedure

An accurate turbidity measurement depends on good measurement techniques. Factors such as clean sample vials, positioning of vial in the sample well, covering the vial with the light shield cap, meter calibration, handling of meter, and others, have to be taken into consideration. Please see the following sections for more information.

Section 5.1: Vials – Handling, Cleaning and Care (page 16)

Section 9: Addendum 2:
Guide to Good Measurement Technique (page 21)

Preparation of Sample Vial

1. Obtain a clean and dry sample vial
2. Take care to handle the sample vial by the top.
3. Rinse the vial with approximately 10 ml of the sample water, capping the vial with the black screw cap and gently inverting it several times. Discard the used sample and repeat the rinsing procedure two more times.
4. Fill the rinsed vial with the remaining portion (approximately 10 ml) of the grab sample up to the mark indicated in the vial. Cap the vial with the supplied black screw cap.
5. Wipe the vial with the soft, lint-free cloth supplied. Ensure that the outside of the vial is dry, clean and free from smudges.
6. Apply a thin film of silicone oil (supplied) on the sample vial (see Figure 9).
7. Wipe with a soft cloth to obtain an even distribution over the entire vial's surface.

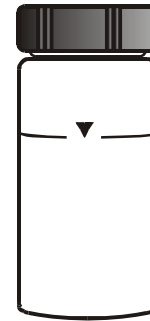

Figure 8: Sample Vial

NOTES:

1. *The purpose of oiling the vial is to fill small scratches and to mask the imperfection in the glass.*
 2. *Do not apply large quantity of oil as this may collect dirt and dust*
8. The sample vial is now ready to be inserted into the sample well of the meter for measurement.

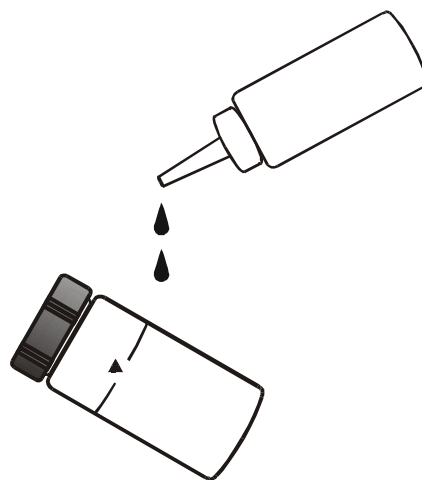

Figure 9: Apply a thin film of silicon oil

Measurement Procedure

1. Place TN-100/ T-100 turbidimeter on a flat and level surface.
2. Place the sample vial inside the sample well and align the vial's index mark with the meter's index mark. See **Figure 10**.

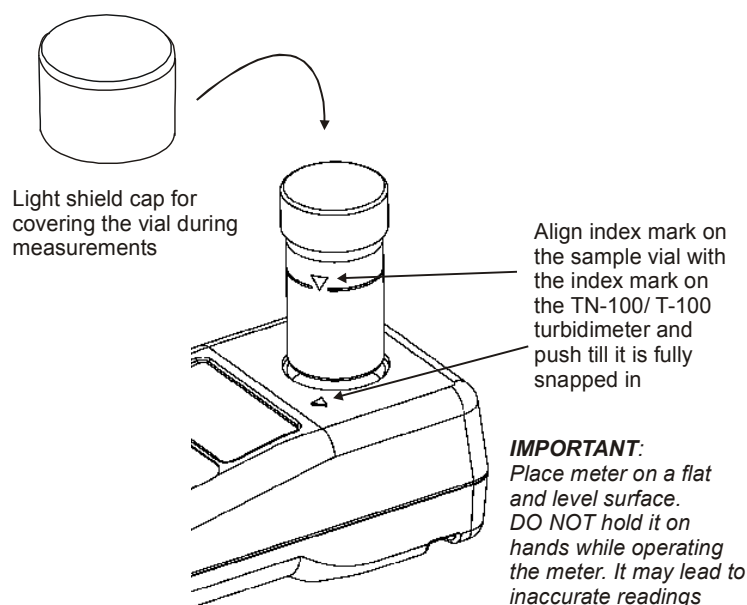

Figure 10: Align sample vial's index mark with meter's index mark

3. Push the vial until it is fully snapped in.
4. Cover the vial with the light shield cap.
5. Turn on the meter by pressing the **ON/OFF** key.
6. After the power-up sequence, the meter goes to measurement mode and the display blinks "--Rd--" for about 10 times. See Figure 11.
7. The measured reading appears in the display.
8. If necessary, place the second sample vial into the sample well. Remember to align the vial's mark with the meter's index mark.
9. Press **READ/ENTER** key. The display blinks "--Rd--" for several times and measured reading appears.
10. Repeat steps 2 through 9 for all of your samples.

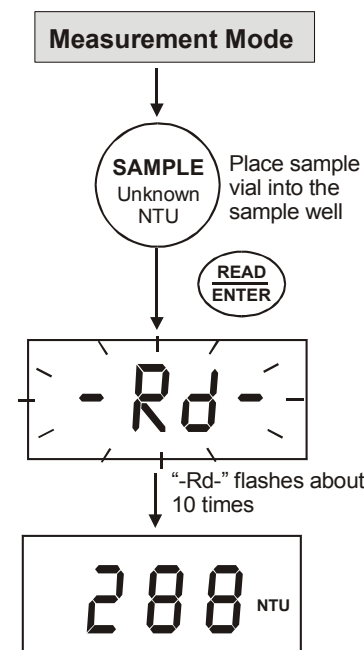

Figure 11: Reading Turbidity Value

NOTES:

1. *NEVER pour liquid directly into the sample well of the instrument. Always use a vial. The instrument will only accurately measure the turbidity of a sample when vials sealed with the black caps are used. The black cap serves as both seal and a light shield.*
2. *NEVER attempt to clean the sample well. The optics may be damaged.*
3. *For battery conservation, the instrument automatically powers off 20 minutes after the last key pressed.*

3.3 Single-Shot or Continuous Measurement

You can use TN-100/ T-100 turbidimeter to take a single reading or perform continuous measurement. The latter is only used for indexing the vials. See **Section 8.5** - Indexing a Vial on page 20 for more information.

For Single-shot Measurement:

1. Make sure the meter is sitting on a flat and level surface and is in measurement mode. The display shows the last measured value or "STbY" after exiting calibration mode.
2. Place sample vial in the sample well.
3. Cover the vial with the light shield cap.
4. Press **READ/ENTER** key and release immediately (<0.3 seconds). See Figure 12.
5. The display blinks "--Rd--" for about 10 times and then display the measured value.

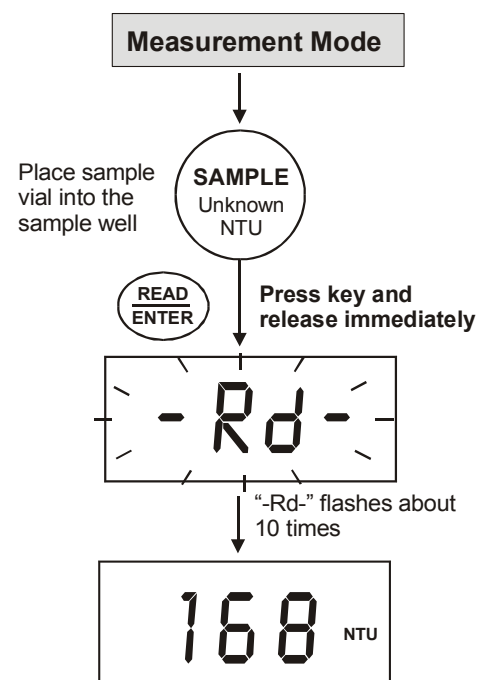

Figure 12: Single-shot Measurement

For Continuous Measurement:

1. Make sure the meter is sitting on a flat and level surface and is in measurement mode. The display shows the last measured value or "STbY"
2. Place the sample vial in the sample well.
3. Press **READ/ENTER** key and hold. See Figure 13
4. Wait for the reading to stabilize before rotating the sample vial.

NOTE: During continuous measurement, the display is updated every 2 seconds. The displayed reading may not be the actual turbidity value. For accurate measurement, use single-shot measurement.

You can rotate the sample vial for indexing purpose. See **Section 8.5** - Indexing a Vial on page 20 for more information.

5. Once you release **READ/ENTER** key, the meter automatically performs a single-shot measurement.

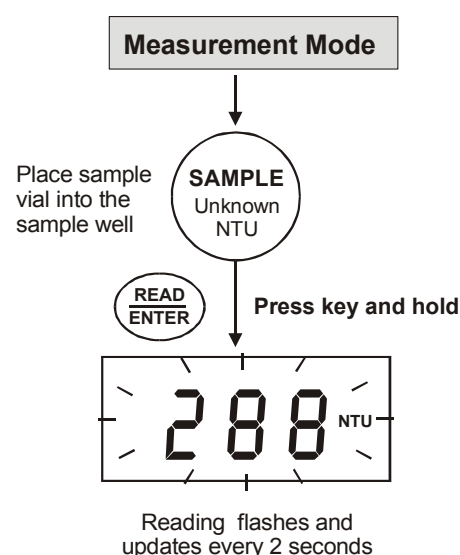



Figure 13: Continuous Measurement

NOTES:

1. After a measurement is completed and the display is updated, a 4-second recovery time occurs before the meter can perform another function. If any key is pressed during the recovery time, the meter will perform the corresponding action at the end of the recovery period.
2. When performing a measurement, if the meter detects stray light exceeding the amount equivalent to 0.02 NTU in the low range, the measurement is immediately aborted and an error message [ERR 8] is displayed. Ensure the vial sits properly into the sample well. Press the ENTER/READ key to re-do the measurement.

4. Troubleshooting Guide

The TN-100/ T-100 turbidimeter routinely performs self-diagnostics, and will automatically generate messages to provide you with specific diagnostic information. These messages are for your use and do not indicate a reduction in the performance of the instrument or a failure of any component in the instrument, unless otherwise stated in this list.

LCD Message	Description	Corrective Actions
ERR 1	Calibration Error. The meter is unable to recognize the 800 NTU Calibration Standard.	Ensure to use the correct 800 NTU calibration standard. *
ERR 2	Calibration Error. The meter is unable to recognize the 100 NTU Calibration Standard.	Ensure to use the correct 100 NTU calibration standard. *
ERR 3	Calibration Error. The meter is unable to recognize the 20.0 NTU Calibration Standard.	Ensure to use the correct 20.0 NTU calibration standard. *
ERR 4	Calibration Error. The meter is unable to recognize the 0.02 NTU Calibration Standard.	Ensure to use the correct 0.02 NTU calibration standard. *
ERR 5	Calibration Error. There is not sufficient signal to achieve the appropriate resolution in the 0-1000NTU range.	Re-do calibration with all 4 standards provided. *
ERR 6	General Calibration Failure. There is not sufficient signal to achieve the appropriate resolution in the 0-100NTU range.	Re-do calibration with all 4 standards provided. *
ERR 7	General Calibration Failure. There is not sufficient signal to achieve the appropriate resolution in the 0-20 NTU range.	Re-do calibration with all 4 standards provided. *
ERR 8	Excessive stray light detected.	Ensure the vial is fully snapped in the sample well.
ERR 8	Attempting a measurement when low battery indicator is on.	Replace batteries.
ERR 9	Lamp Failure.	Return unit.
Or	When Turbidity value is above the measurement range(>1000NTU)	Dilute sample. See Section 9.7 on page 23.
	Low battery indication. The batteries need to be replaced.	Replace batteries.

* If an error message appears, take the appropriate corrective action and re-do the desired procedure. If the problem persists, contact Eutech Instruments or your dealer. See Sections on Warranty and Return of Items on page 24.



5. Routine Maintenance

The supplied carrying case is optimal for protecting the instrument. If you do not plan on leaving the instrument in the supplied carrying case, when not in use, ensure that the instrument has been turned off and that a clean sample vial fitted with a black cap has been placed in the sample well. This will ensure that a minimal amount of dust and/or debris will be able to settle on the optics of the instrument.

5.1 Vials – Handling, Cleaning and Care

Proper measurement of the turbidity of a sample requires the use of a vial that is free of marks, smudges, scratches and any bacterial growth.

Therefore, sample vials must be handled with absolute care to avoid contamination or damage, which might change the optical characteristics of the glass. Scratches, fingerprints, and water droplets on the sample vial or inside the sample well can cause stray light interference leading to inaccurate readings.

Cleaning the vial is accomplished by washing the interior and exterior of the vial in a detergent solution. Once cleaned, the vial should be rinsed thoroughly 8 to 10 times with clean distilled water to eliminate the possibility of detergent buildup and streaking.

Vials can also be acid washed periodically and coated with a special silicone oil to fill small scratches and mask the imperfections in the glass. Since the silicone oil required for this application should have the same refractive characteristics as glass, it is recommended that the oil be obtained from us. Care should be taken not to apply excessive oil that could attract dirt or contaminate the sample well of the meter. Once the oil has been applied to the vial, the excess oil should be removed with a lint-free cloth. The result should be a sample vial surface with a dry appearance, but with all imperfections filled with oil.

Sample vials should always be handled from the top or by the cap to avoid fingerprints or smudges. After a vial has been filled with a sample and capped, the outside surface should be wiped with a clean, lint-free absorbent cloth until it is dry. Cleaned and dried vials should be stored with the black caps on. The vials can be stored in the carrying case. During normal operation you may use any typical glass cleaner along with a lint free cloth or tissue (Kimwipes®), to clean the outside of the vials.

Condensation may appear on the vial when your sample is very cold and the relative air humidity is high. When this happens, the turbidity that you read may be higher than the actual turbidity due to the light scattered by the condensate on the vial. If you find yourself in this circumstance, you can alleviate the problem by either coating the vial with an anti-fogging agent, or by running warm water over the vial for a short period of time to warm the sample prior to measurement.

6. Accessories

The items shown below are recommended accessories and replacement parts for the instrument.

Item Description	Eutech Instruments Order Code	Oakton Instruments Order Code
Waterproof TN-100/ T-100 portable turbidimeter with set of 4 calibration standards (800, 100, 20.0 & 0.02 NTU), set of 3 sample vials, lint-free cloth, silicone oil, batteries – all in a rugged carrying case.	EC-TN100	35635-00
Calibration Set for normal operation (includes 800, 100, 20.0 & 0.02 NTU Standards)	ECTN100CALKT	35635-50
Sample Vials – pack of 3 vials	ECTN100CUVKT	35653-55
Silicone Oil – 10ml	ECSILICONEOIL	~

To order any accessory or replacement part, please contact the nearest distributor or Eutech Instruments/ Oakton Instruments.

7. Specifications

Parameter	Specification
Measurement Method	ISO 7027 compliant nephelometric method (90°)
Measurement Range	0 to 1000 NTU
Automatic Range Selection	0.01 – 19.99 NTU 20.0 – 99.9 NTU 100 – 1000 NTU
Resolution	0.01 NTU (0 – 19.99 NTU) 0.1 NTU (20 – 99.9 NTU) 1 NTU (100 – 1000 NTU)
Accuracy	±2% of reading ± 1 LSD for 0 to 500 NTU; ±3% of reading ± 1 LSD for 501 to 1000 NTU.
Repeatability	± 0.01 NTU or ± 1% of reading, whichever is greater with gel samples
Response Time	< 6 seconds for full step change
Calibration Standards	0.02 NTU; 20 NTU; 100 NTU; 800 NTU
Standardization	EPA-approved polymer-based primary standards
Light Source	Infrared-emitting diode (850 nm wavelength)
Light Source Life	> 1,000,000 tests
Detector	Silicon photovoltaic
Stray Light	< 0.02 NTU
Display	4-digit 14-segments customized liquid crystal display with annunciators
Sample Cells (Vials)	Borosilicate glass with screw caps, fill line and indexing mark. 51 (H) x 25 (Dia) mm (2 x 1 in)
Sample Volume Required	10 ml (0.33 oz)
Operating Temperature Range	0°C to 50°C (32°F to 122°F)
Sample Temperature Range	0°C to 50°C (32°F to 122°F)
Operating Humidity Range	0-90% RH, non-condensing at 30°C (86°F)
Power Supply	4 x "AAA" Alkaline Batteries
Battery Life	> 1200 readings
Enclosure Type & Rating:	ABS Plastic / IP67 rated
Insulation Rating	Pollution Degree 2
Weight:	Meter: 200 g (7 oz) Meter with case: 1.25 kg (2.75 lb)
Dimensions	Meter: 6.8 (W) x 15.5 (L) x 4.6 (H) cm; (2.7 x 6.1 x 1.8 in) Meter with Case: 16 (W) x 35 (L) x 12 (H) cm; (6.3 x 13.8 x 4.7 in)

8. Addendum 1: Turbidity

8.1 Definition

Turbidity is defined as an “*expression of the optical property that causes light to be scattered and absorbed rather than transmitted in straight lines through the sample.*”¹ That is, turbidity is the measure of relative sample clarity, not colour.

Water with cloudy or opaque appearance will have high turbidity, while water that is clear or translucent will have low turbidity. High turbidity value is caused by particles such as silt, clay, microorganisms, and organic matter. By definition, turbidity is not a direct measure of these particles but rather a measure of how these particles scatter light.

8.2 Why Is It Important?

For drinking water application, a turbidity value may give an indication of presence of bacteria, pathogens, or particles that can shelter harmful organisms from disinfection process. Therefore, turbidity measurement is particularly useful for water treatment plants to ensure cleanliness.

In industrial processes, turbidity can be part of quality control measure to ensure efficiency in treatment or manufacturing process.

8.3 Measurement Principle

There are two internationally accepted standard specifications for turbidity measurement. These are the international standard ISO 7027 and the US EPA method 180.1.

Basically the ISO 7027 is a more stringent standard and requires the use of a monochromatic light source. It also governs the design of a turbidimeter in the following areas: (1) Light source's wavelength; (2) Light sources' spectral bandwidth; (3) Measuring angle; (4) Aperture angle in water sample; (5) Distance traversed by incident light and scattered light within the sample; (6) Calibration standard.

The TN-100/ T-100 turbidimeter follows the ISO 7027 standard whose specification allows for greater reproducibility of the measured values and greater agreement between other measuring instruments.

¹ Provided by “Standard Methods for the Examination of Water and Wastewater, APHA, AWWA and WPCF, 16th Edition, 1985.

Figure 14 shows the waterproof TN-100/ T-100 turbidimeter basic optical system. It includes a light source and a detector to monitor the light scattered at 90° with respect to the incident beam.

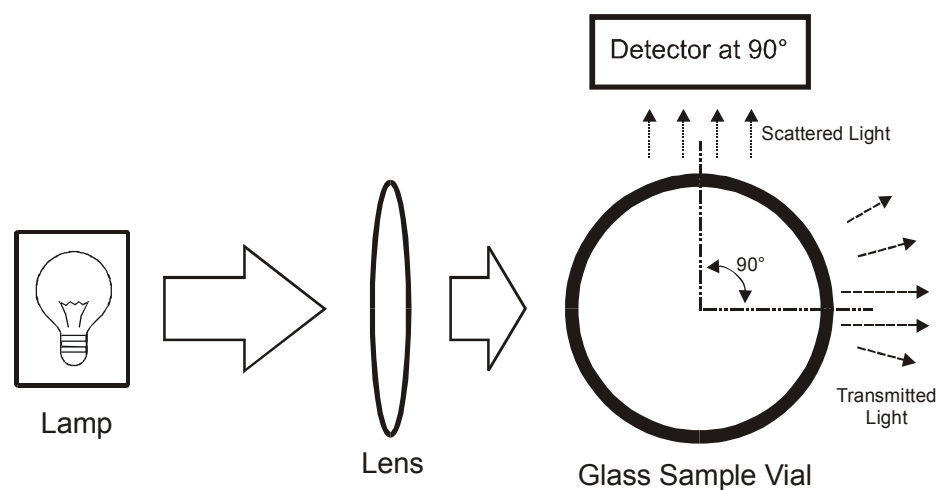

Figure 14: Basic Nephelometric arrangement for turbidity measurement

8.4 Nephelometric Turbidity Units (NTU)

Nephelometric Turbidity Units (NTU): Unit of measure used when relating the light scattered by a liquid media to the light scattered by a known concentration of a standard solution. This unit of measure is recognized as a measure of the optical clarity of an aqueous sample. NTU is the accepted unit of measurement for turbidity.

Another unit commonly used to measure turbidity is Formazin Turbidity Unit (FTU). The two units of measure of turbidity are equivalent: 1 NTU = 1 FTU.

8.5 Indexing a Vial

The United States Environmental Protection Agency (US EPA) recommends that vials used for turbidimeter calibration or sample measurement be indexed.

To index a sample vial, slowly rotate the vial throughout one complete revolution (360°). While rotating the sample vial, observe the display and locate the position that the vial is in which provides the lowest turbidity reading. This position is the indexed position of the vial.

Mark this position on the vial (not on the cap) against the mark on the meter.

After indexing a vial, make sure the vial will always be placed inside the sample well in the indexed position.

9. Addendum 2: Guide to Good Measurement Technique

Turbidity is a very complex analytical measurement which can be affected by many factors. Some are inherent in the instrument's design such as angle of detection, light beam aperture, incident beam wavelength and color sensitivity of the photocell.

However, there are other factors such as stray light, air bubbles and care of vial, which can be prevented through proper care of equipment and accessories, and in the operating procedure for measurement. Here are some points you may want to note:

9.1 Maintain sample vials in good condition

Sample vials must be meticulously clean and free from significant scratches. It should be treated on the outside with a thin coat of silicone oil. This is to mask minor imperfections and scratches that may contribute to stray light. Sample vials should be handled only by the top to avoid dirt accumulation (or deposits) and fingerprints that might interfere with the light path.

More information is found in Section 5.1 - Vials – Handling, Cleaning and Care on page 16.

9.2 Match Sample Vials

Best accuracy and repeatability of turbidity measurement are achieved using a single, indexed vial. However, for more convenience, different vials can be used for measurement provided their readings with the same solution are matched. That is, the meter gives identical readings or within the specified repeatability and accuracy of the meter.

Select a few vials. After the sample vials are cleaned, fill them with ultra-low turbidity water. Allow the sample vials to stand and for air bubbles to rise. Polish sample vials with silicone oil and take turbidity measurement at several points while rotating it in the sample well. Find the position where turbidity reading is the lowest and index it for each vial. Whenever these sample vials are used, use the indexed mark to position each vial into the sample well. Choose those vials that match the readings.

NOTE: *Not all vials can be matched because of some manufacturing variations.*

9.3 Degassing

Air or other trapped gases should be removed before measurement. Degassing is recommended even if no bubbles are visible. There are three methods commonly used for degassing:

- Addition of a surfactant: This involves adding a surfactant to the water samples to lower the surface tension of the water, thereby releasing trapped gasses.
- Application of a partial vacuum: Partial vacuum can be created by using simple syringe or vacuum pump. (This is only recommended for ultra-low turbidity measurement).
- Use of an ultrasonic bath: This may be effective in severe conditions or in viscous samples, but not recommended for ultra-low measurements.

Each of the method above has its own advantages and disadvantages. For instance, under certain sample conditions, the use of vacuum pump or ultrasonic bath may actually increase the presence of gas bubbles.

9.4 Timeliness of Sample

Samples should be measured immediately to prevent changes in particle characteristics due to temperature and settling. Temperature can affect particles by changing their behavior or creating new particles if precipitates are formed. Dilution water may dissolve particles or change their characteristics. It is recommended to take samples only when the turbidimeter is ready to be operated. Samples should not be drawn and allowed to sit while the instrument warms up or is being readied.

9.5 Other Important Sampling Techniques

1. Samples should not be violently shaken or agitated as particles can be broken apart or air may be entrapped into the fluid. Gentle agitation such as swirling the sample vial is advisable to reduce particle settling.
2. Sample vials should be used only with the instruments for which they were intended. Do not mix and match.
3. Perform a visual observation of the sample vial every time a measurement is made. Ensure that there are no visible bubbles in the sample and the vial is clean and free of scratches.
4. Samples entering the turbidimeter should be at the same temperature as the process flow samples. Changes in temperature can cause precipitation of soluble compounds and affect readings.
5. Sample vials should be evaluated with a low turbidity water (after cleaning) to determine if cells remain matched. If the evaluation determines that a cell is corrupted, discard the vial. It is recommended to conduct this evaluation weekly.
6. When in doubt or question about whether a sample vial is too scratched or stained, throw it away.

9.6 Calibration

1. Do not open the vials with calibration standards.
2. Check that the standards have not expired.
3. Make sure the calibration vials are free of dust, smudges and scratches before use.
4. Conduct the calibration in the same manner each time. Variations in how calibration is performed could yield inaccurate measurements.
5. It is very important that the user(s) who perform calibration have been trained to do so. Creating a Standard Operating Procedure (SOP) for the user(s) to read, learn, and practice may help to ensure accuracy.

9.7 Dilution

This dilution procedure is necessary only when your turbidity measurement is above 1000 NTU.

1. To measure the turbidity above 1000 NTU, dilute the sample with turbidity-free water.
2. Turbidity-free water can be obtained by filtering deionized water through a < 0.2µm filter membrane with precision-sized pores.
3. Measure the volume of the sample before dilution and record the value in ml (Vs).
4. Take a known volume (Vd) of dilution water and add it to the sample.
5. Pour 10 ml of the diluted sample in a clean vial and measure the turbidity of the diluted sample. Record this value in NTU (Td).
6. Calculate the true turbidity (T) of the original sample - in NTU - using the following formula:

$$T = Td * (Vs + Vd) / Vs$$

Example:

- Dilute 20 ml of the original sample (whose turbidity is above 1000NTU) with 50 ml of dilution water.
- Measure the turbidity of the diluted sample.
- If the reading is 300 NTU, the turbidity of the original sample is 1050 NTU. (In this case: Td=300NTU, Vs=20ml, Vd=50ml, so T = 300 * (20+50) / 20 = 300*70/20 = 21000/20 = 1050)