



VOLT-100 WIRELESS

cps[®] AC750 DIGITAL CLAMP METER

Please insert latest front view VOLT100 image (throughout)



OWNER'S MANUAL (English)





CONTENTS



1. Safety Information

1.1 Preliminary	1
1.2 Usage	2
1.3 Symbols	3
1.4 General Use	4

2. Description

2.1 AC750 Layout	5
2.2 Switch, Key and Input Jack Description	6
2.3 LCD Display	7-8



3. Specifications



3.1 General	9
3.2 Technical Data	10-15

4. Operating Instructions

4.1 Reading Hold	16
4.2 Manual Measuring Range	16
4.3 Frequency Duty/Ratio Switch	16
4.4 Maximum / Minimum Measurement	17
4.5 Function Key	17
4.6 INRUSH Measurement	17
4.7 Back Light And Clamp Head Light	18
4.8 Automatic Power-Off	18
4.9 Measurement Preparation	18



-

CONTENTS



- 4.10 Current Measurement..... 19
- 4.11 Voltage Measurement..... 20
- 4.12 Frequency and Duty Ratio Measurement..... 20
- 4.13 Resistance Measurement 21
- 4.14 Diode Test..... 21
- 4.15 Circuit Continuity Test..... 22
- 4.16 Capacitance Measurement 22
- 4.17 Surge Current Measurement..... 22
- 4.18 Non-Contact Voltage Detection 23



5. Wireless Operation



- 5.1 Connection..... 24
- 5.2 Data Logging 25
- 5.3 Cost of Operation 26

6. Maintenance

- 6.1 Calibration..... 27
- 6.2 Battery Replacement 27
- 6.3 Probe Replacement 27

7. Accessories28

8. Warranty.....29



1. SAFETY INFORMATION

WARNING

BE EXTREMELY CAREFUL WHEN USING THIS METER. IMPROPER USE OF THIS DEVICE CAN RESULT IN ELECTRIC SHOCK OR DESTRUCTION OF THE METER. TAKE ALL NORMAL SAFETY PRECAUTIONS AND FOLLOW THE SAFEGUARDS SUGGESTED IN THIS MANUAL. TO EXPLOIT FULL FUNCTIONALITY OF THIS METER AND ENSURE SAFE OPERATION, PLEASE READ CAREFULLY AND FOLLOW THE DIRECTIONS IN THIS MANUAL. IF THE EQUIPMENT IS USED IN A MANNER NOT SPECIFIED BY THE MANUFACTURER, THE PROTECTION PROVIDED BY THE EQUIPMENT MAY BE IMPAIRED.

This meter is designed and manufactured according to safety requirements of EN 61010-1, EN 61010-2-032, EN 61010-2-033 concerning electronic measuring instruments with a measurement CAT III 1000V, CAT IV 600V and pollution degree 2 and safety requirements for hand-held clamps for electrical measurement and test.



1.1 PRELIMINARY

- 1.1.1 When using this meter, comply with standard safety rules:
 - General shock protection
 - Prevent misuse of this meter
- 1.1.2 After receiving meter, check for any transportation damage that may have occurred.
- 1.1.3 If meter was stored or shipped under harsh conditions, confirm if meter has been damaged.
- 1.1.4 Probe should be in good condition. Before use, check if probe insulation is damaged and no bare metal wires are found.
- 1.1.5 Use the probe table provided with the meter to ensure safety. If necessary, replace either probe with identical probe or one with the same level of performance.













1. SAFETY INFORMATION

1.2 USAGE

- 
- 
- 1.2.1 **DO NOT** measure voltage greater than 750 V AC, 1000 V DC.
 - 1.2.2 **DO NOT** measure resistor, capacitor, diode and circuit while connected to power.
 - 1.2.3 **DO NOT** measure capacitance before capacitor is discharged completely.
 - 1.2.4 **DO NOT** use meter in explosive gas, vapor or dusty environments.
 - 1.2.5 **DO NOT** store or use meter in direct sunlight, high ambient temperature or high humidity.
 - 1.2.6 During test of currents, resistors, capacitors, diodes and circuit connections, **DO NOT** connect meter to a voltage source.
 - 1.2.7 **DO NOT** use unless meter bottom case and battery cover are completely fastened.
 - 1.2.8 During use, select the right function and measuring range.
 - 1.2.9 During measurement, **DO NOT** exceed the indicated value for each range.
 - 1.2.10 When measuring a circuit with the meter connected, **DO NOT** contact with probe tip (metal part).
 - 1.2.11 During measurement, if voltage to be measured is more than 60 V DC or 30 V AC (RMS), **always keep fingers behind finger protection device**
 - 1.2.12 In the manual measuring range mode, when measuring an unknown value, select the highest measuring range first.
 - 1.2.13 Before rotating **Selector Switch** to change measuring function, remove probe from circuit to be measured.
 - 1.2.14 If you find any abnormal phenomena or failure of meter, stop using immediately.

1. SAFETY INFORMATION

	Note-Important safety information, refer to the instruction manual.
	Application around and removal from UNINSULATED HAZARDOUS LIVE conductors is permitted.
	Caution, possibility of electric shock
	Equipment protected throughout by double insulation or reinforced insulation.
	Conforms to UL STD. 61010-1, 61010-2-032, 61010-2-033; Certified to CSA STD C22.2 NO. 61010-1, 61010-2-032, 61010-2-033
	Complies with European (EU) safety standards
	Earth (ground) terminal
	Direct current
	Alternating current
	Both direct and alternating current
CAT III	It is applicable to test and measuring circuits connected to the distribution part of the building's low-voltage MAINS installation.
CAT IV	It is applicable to test and measuring circuits connected at the source of the building's low-voltage MAINS installation.





1. SAFETY INFORMATION

1.4 GENERAL USE

- 1.4.1 Do not open case to adjust or repair (only for technicians who fully understand this meter and electrical shock hazard).
- 1.4.2 Before opening case or battery cover, remove probe from circuit to be measured.
- 1.4.3 To avoid wrong readings causing electric shock, when “” appears on meter display, replace battery immediately.
- 1.4.4 Clean meter with damp cloth and mild detergent. Do not use abrasives or solvents.
- 1.4.5 Set **Selector Switch** to OFF position when meter not in use.
- 1.4.6 If meter is not used for an extended time, remove battery.

2. DESCRIPTION

2. DESCRIPTION

- 
- This meter is a portable, professional multifunction measuring instrument with LCD display and back light. **Selector Switch** is operated with one hand for easy operation.
 - This meter is for measuring AC current, DC current, AC voltage, DC voltage, frequency, duty ratio, resistance, capacitance measurement, circuit connection, diode test and non-contact voltage detection.
- 

Other features include:

- Automatic measuring range and manual measuring range
- Overload protection
- Reading hold function
- Max and Min measuring function
- Clamp head frequency measurement function
- Auto power-off function
- Relative measuring function
- Low battery indicator

2. DESCRIPTION

2.1 VOLT-100 LAYOUT

1. Current clamp head (for current measurement)
2. Clamp head light
3. Control panel
4. Jaw Trigger
5. Function choicekey (**FUNC**)
6. Relative measurement key
7. Frequency/duty ratio switch key (Hz/%)
8. LCD display
9. Common endjack
10. Resistance, capacitance, voltage, frequency, diode and continuity input jack
11. Maximum/minimum choice key (MAX/MIN)
12. Reading hold/ Back light key (BL/ HOLD)
13. Selector Switch
14. NCV indicator
15. Protective Barrier (limit of safe access)
16. Wire pick

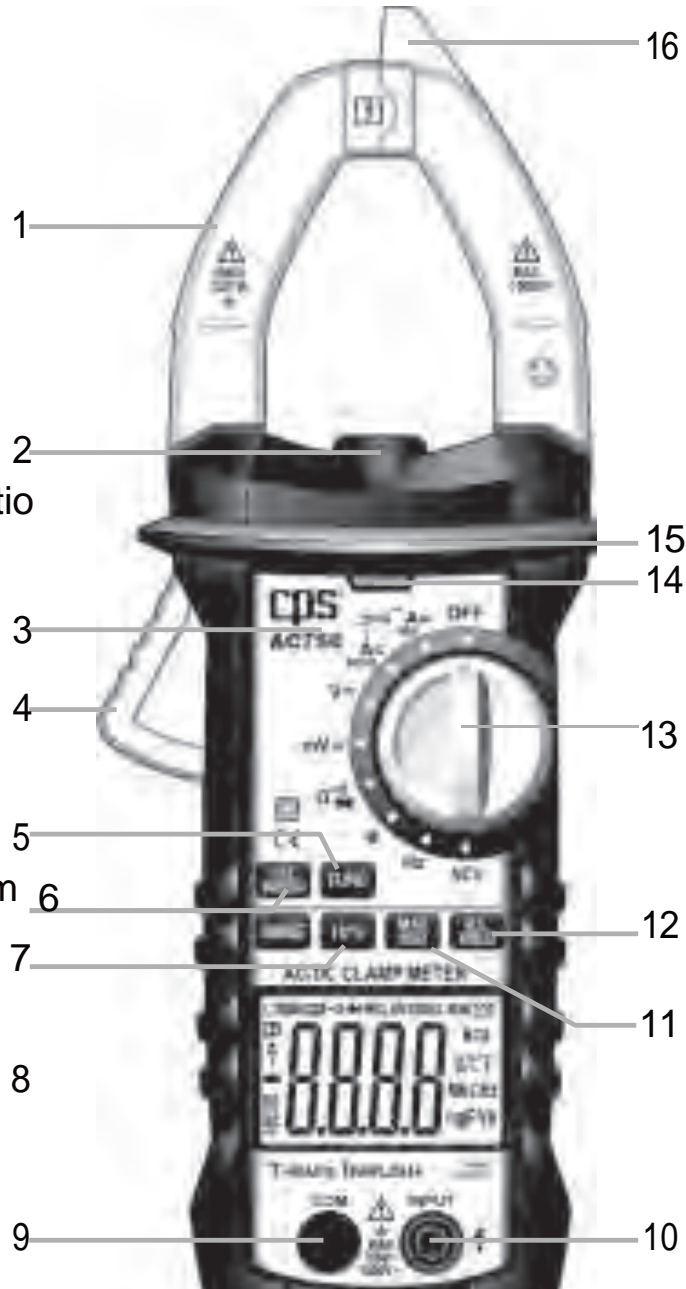

Change all of the key locations to the new key names (example: 12 is now the Link/REL button)

2. DESCRIPTION

2.2 SWITCH, KEY AND INPUT JACK DESCRIPTION

BL/HOLD	Back light or reading hold key
FUNC	Function key (use with Selector Switch)
RANGE	For switching manual measuring range state
Link/REL	For connecting to Bluetooth smart device and entering relative measurement state
Hz/%	For frequency and duty ratio measurement function switch
MAX/MIN	For maximum/minimum measurement function switch
OFF	For turning power OFF
INPUT Jack	Voltage, resistance, frequency, duty ratio, capacitance, diode, circuit connection input wire connecting terminal
COM Jack	Voltage, resistance, frequency, duty ratio, capacitance, diode, circuit connection common wire connecting terminal
Selector Switch	For selecting function and measuring range

2. DESCRIPTION

2.3 LCD DISPLAY

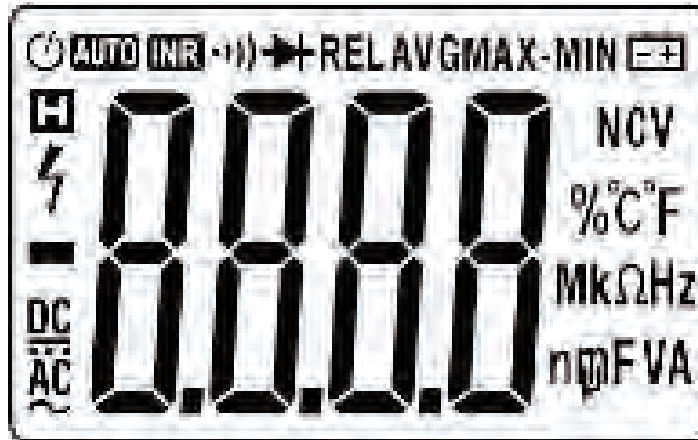

	Automatic power-off indicator
AUTO	Automatic measuring range mode
INR	Surge current test
	Diode, on/off
REL	Relative measurement mode
MAX /MIN	Maximum/minimum measurement
NCV	Non-contact voltage detector
Ω, kΩ, MΩ	Ohm, Kilohm, Megohm (resistance)
nF, μF, mF	Nano farad, Microfarad, Millifarad
AC, DC	Alternating current, direct current
H	Reading hold state
Z	DC current zeroing function
	Low battery icon
%	Percentage (duty ratio)
mV, V, A	Millivolt, Volt (voltage), Ampere (current)
Hz, kHz, MHz	Frequency range

3. SPECIFICATIONS

3.1 GENERAL

Maximum Input Current	1000A AC; 1000A DC
Maximum Input Voltage	750V AC (RMS); 1000V DC
AC Volts	6mV/600mV/6V/60V/600V/750V (+/- 0.6% reading); 750V (+/- 0.8% reading)
DC Volts	6mV/600mV/6V/60V/600V/1000V (+/- 0.5% reading); 1000V (+/- 0.8% reading)
AC Amps	60/600/1000 (+/- 2% reading)
DC Amps	60/600/1000 (+/- 2% reading)
OHMs	600/6K/60K/600K/6M/60M (+/- 2% reading)
Frequency (Through Jaw Clamp)	99.99 Hz to 999.9 Hz
Frequency (Through Mode V)	99.99 Hz to 9.999kHz
Frequency (Through Mode HZ/DUTY)	9.999 Hz to 9.999 MHz
Measuring Range Overload Protection	Yes (Full Range)
Sampling Rate	Approx. 3 times/sec.
LCD Display Auto-Off	After 15 minutes (if no operation)
Test Leads (Red, Black)	39" (1 m), Included
Battery Undervoltage Indication	Display shows 
Polarity Indication	Automatic ("-" = negative polarity)
Display Indication (Exceeds Max Range)	"OL" or "-OL"
Temperature Coefficient	<0.1 X accuracy/°C
Clamp, Max Opening	1.6" (42 mm)
Full measuring range overload protection	Yes
Battery	One 9V DC (Included)
Operation Temperature	32°F~122°F (0°C ~ 50°C)
Storage Temperature	-14°F~122°F (-10°C ~ 50°C)
Size (H x W x D)	9.4" x 1.9" x 3.6" (238 x 50 x 92 mm)
Weight (Including Battery)	0.92 lb (420 g)

3. SPECIFICATIONS

3.2.1 TRUE RMS ZERO INPUT CHARACTERISTIC

- 3.2.1.1 For measuring non-sinusoidal wave signals, use true RMS measuring method, which has less error than traditional average response measuring method.
- 3.2.1.2 This true RMS meter can accurately measure non-sinusoidal wave signals, but in AC function mode, when there is no signal to be measured (input terminal short circuit in AC voltage mode), clamp meter may show a reading from 1 to 50. These deviating readings are normal. In the designated measurement range, they will not affect the accuracy for multimeter measuring AC.
- 3.2.1.3 True RMS can be measured only when input signal reaches a certain level. Therefore, the measuring range of AC voltage and current should be specified at 2% ~ 100% of full range.

3.2.2 AC CURRENT

Measuring range	Resolution	Accuracy
60A	0.01A	±(2.5% reading + 8 digits)
600A	0.1A	
1000A	1A	

- Maximum input current: 1000A AC
- Maximum input current: 0~600A: 40~400Hz;
600A~1000A: 40~60Hz

3. SPECIFICATIONS

3.2.3 DC CURRENT

Measuring range	Resolution	Accuracy
60A	0.01A	±(2.0% reading + 8 digits)
600A	0.1A	
1000A	1A	

- Maximum input current: 1000A DC

3.2.4 SURGE CURRENT

Measuring range	Resolution	Accuracy
60A	0.01A	< 60A for reference only
600A	0.1A	±(5% reading + 60 digits)
1000A	1A	

Time of integration: 100ms;
Measurement range: 20-1000A
Frequency range: 40-400Hz

3.2.5 DC VOLTAGE

Measuring range	Resolution	Accuracy
600mV	0.1mV	±(0.5% reading + 5 digits)
6V	0.001V	
60V	0.01V	
600V	0.1V	
1000V	1V	±(0.8% reading + 4 digits)

- Input impedance: 10M Ω
- Maximum input voltage: 750V AC (RMS) or 1000V DC

Note: In the small voltage measuring range, the probe is not connected with the circuit to be tested, and the meter may have fluctuating readings, which is normal and caused by the meter's high sensitivity. This does not affect actual measurement results.

3. SPECIFICATIONS

3.2.6 AC VOLTAGE

Measuring range	Resolution	Accuracy
600mV	0.1mV	±(0.8% reading + 5 digits)
6V	0.001V	
60V	0.01V	
600V	0.1V	
750V	1V	±(0.8% reading + 4 digits)

- Input impedance: 10M
- Maximum input voltage: 750V AC (RMS) or 1000V DC
- Frequency range: 40 - 400Hz

Note: In the small voltage measuring range, the probe is not connected with the circuit to be tested, and the meter may have fluctuating readings, which is normal and caused by the meter's high sensitivity. This does not affect actual measurement results.

3.2.7 FREQUENCY

3.2.7.1 Clamp head measuring frequency (through range A):

Measuring range	Resolution	Accuracy
99.99Hz	0.01Hz	±(1.5% reading + 5 digits)
999.9Hz	0.1Hz	

- Measuring scope: 10Hz-1kHz
- Input signal range: 20A AC (RMS) (input current will increase when the frequency to be measured increases)
- Maximum input current: 1000A (RMS)

3.2.7.2 Through mode V:

Measuring range	Resolution	Accuracy
99.99Hz	0.01Hz	±(1.5% reading + 5 digits)
999.9Hz	0.1Hz	
9.999Hz	0.001kHz	

- Measuring scope: 10Hz - 10kHz
 - Input signal range: 20A AC (RMS) (input current will increase when the frequency to be measured increases)
 - Input impedance: 10M
- 14 • Maximum input voltage :750V AC (RMS)

3. SPECIFICATIONS

3.2.7.3 Through mode HZ/DUTY:

Measuring range	Resolution	Accuracy
9.999Hz	0.01Hz	±(0.3% reading + 5 digits)
99.99Hz	0.1Hz	
999.9Hz	0.001kHz	
9.999kHz	0.01kHz	
99.99kHz	0.1kHz	
999.9kHz	0.001MHz	
9.999MHz	0.001kHz	

- Overload protection: 250V DC or AC (RMS)
- Input voltage range: 2V (input voltage will increase when the frequency to be measured increases)

3.2.8 Duty Ratio

Measuring range	Resolution	Accuracy
0.1-99.9%	0.1%	±3.0%

3.2.8.1 Through mode A (from clamp head):

- Frequency response: 10-1kHz
- Input current range: ≥ 20A AC (RMS)
- Maximum input current: AC 1000A

3.2.8.2 Through mode V:

- Frequency response: 10-10kHz
- Input voltage range: ≥ 60mV AC
- Input impedance: 10M
- Maximum input voltage: 750V AC (RMS)

3.2.8.2 Through mode HZ/DUTY:

- Frequency response: 10 - 10MHz
- Input voltage range: ≥ 2V AC (RMS) (input voltage will increase when the frequency to be measured increases)
- Maximum input voltage: 250V AC (RMS)

3. SPECIFICATIONS

3.2.9 RESISTANCE

Measuring range	Resolution	Accuracy
600 Ω	0.1 Ω	$\pm(0.8\%$ reading + 3 digits)
6k Ω	0.001k Ω	
60k Ω	0.01k Ω	
600k Ω	0.1k Ω	
6M Ω	0.001M Ω	$\pm(2.0\%$ reading + 5 digits)
60M Ω	0.1M Ω	

- Open circuit voltage: about 0.4 V
- Overload protection: 250 V DC or AC (RMS)

3.2.10 CIRCUIT CONTINUITY TEST

Measuring range	Resolution	Function
	0.1 Ω	If the resistance of circuit to be measured is less than 50 Ω , the meter's built-in buzzer may sound.

- Overload protection: 250 V DC or AC (RMS)

3.2.11 CAPACITANCE

Measuring range	Resolution	Accuracy
9.999nF	0.001nF	$\pm(3.0\%$ reading + 5 digits)
99.99nF	0.01nF	
999.9nF	0.1nF	
9.999 μ F	0.001 μ F	
99.99 μ F	0.01 μ F	
999.9 μ F	0.1 μ F	
9.999mF	0.001mF	
99.99mF	0.01mF	

- Overload protection: 250 V DC or AC (RMS)

3. SPECIFICATIONS

3.2.12 DIODE TEST

Measuring range	Resolution	Function
	0.001V	Display approximate diode forward voltage value

- Forward DC current is about 1mA
- Backward DC voltage is about 3.3V
- Overload protection: 250V DC or AC (RMS)

4.1 READING HOLD

1. During measurement, if reading hold is required, press “HOLD/BL” key and the value on the display will be locked. Press “HOLD/BL” key again to cancel reading hold state.

4.2 MANUAL MEASURING RANGE

1. RANGE key is automatic/manual measuring range key to trigger mode. The preset range is automatic measuring range. Press to switch to manual measuring range. In manual measuring range mode, click once to change to upper range. Continue to the top range, then continue to press this key to change to the bottom range, followed by recycling. If this key is pressed more than 2 seconds, it will switch back to automatic measuring range state.

Note: In capacitance and frequency measurement state, rhw manual measuring range key is invalid.

4.3 FREQUENCY/DUTY RATIO SWITCH

1. When meter is in AC voltage mode, if “Hz/%” key is pressed, the meter will measure Hz, and measure AC voltage, AC current signal frequency. Click “Hz/%” key again and meter will measure DUTY cycle, voltage and current signal duty ratio. If in HZ/DUTY position, pressing HZ % key will switch between HZ and DUTY by recycling.
2. If “Hz/%” key is pressed again, meter will revert to voltage, current measurement state.



4. OPERATING GUIDANCE





Note: If meter is in maximum/minimum value measurement state, it cannot switch to frequency, duty ratio measurement mode.

4.4 MAX/MIN MEASUREMENT CHOICE

1. Press “MAX/MIN” key to enter MAX mode, and always keep measurement maximum value; press “MAX/MIN” key again, to enter minimum value measurement state; press “MAX/MIN” key for the third time and the meter will display the difference of maximum and minimum value; press “MAX/MIN” key to repeat the above operations by recycling.
2. After entering MAX or MIN mode, meter will automatically save the measured maximum or minimum value.
3. If the user presses “MAX/MIN” key more than 2 sec, meter will restore normal measuring range.

Note:

- 
- a) When meter is in maximum/minimum value measurement state, it is in manual measuring range mode.
 - b) When meter is in frequency, duty ratio measurement state, it cannot switch to maximum/minimum value measurement mode.
- 

4.5 FUNCTION SWITCH

1. In resistance mode, press **FUNC** key and meter will switch among resistance, diode and continuity detection by recycling.
2. In voltage and current mode, press **FUNC** key to switch between AC and DC.

4.6 REL/INRUSH MEASUREMENT

1. **REL/INRUSH** key is relative value measurement key. Pressing this key will enter relative value measurement mode. The current display value can be stored in the memory as reference value. When the user measures later, the display value is the difference for input value minus reference value. ie. **REL** (current reading) = Input value - Reference value.
2. The relative value measurement can only be performed in manual mode.







4. OPERATING GUIDANCE

- 
3. In AC current measurement state, press **REL/INRUSH** more than 2 seconds to enter surge measuring state.

4.7 BACKLIGHT AND CLAMP HEAD LIGHT

1. During measurement, if ambient light is too dark to read the display, press and hold “BL/HOLD” key to activate backlight. Backlight will automatically turn off after 30 seconds.
2. During this period, pressing “BL/HOLD” key more than two seconds will turn OFF backlight.
3. In the current mode, meter will turn backlight and clamp head light on. Backlight uses an LED with high current draw. Backlight will turn off after 30 seconds. Using backlight often will shorten battery life.



Note: When battery voltage $\leq 7.2\text{V}$, the LCD displays “” under-voltage symbol. If using backlight and battery voltage drops below 7.2 V due to high working current, the  symbol may appear and measurement accuracy is not guaranteed. Continue to use meter normally without using the backlight. Do not replace battery until  symbol shows under normal conditions.



4.8 AUTOMATIC POWER-OFF



1. After powering on, and if meter isn’t used for 15 minutes, meter will enter suspended state, automatically powering off to save the battery. Within 1 minute before shutdown, buzzer will sound five times. Meter will then enter a dormant state.
2. After automatic power-off, press **FUNC** key, to turn meter on again.
3. Holding **FUNC** key when powering on cancels automatic power-off function.



4. OPERATING GUIDANCE



4.9 MEASUREMENT PREPARATION

1. Rotate the **Selector Switch** to turn on power. When battery voltage is low (about ≤ 7.2 V), LCD displays  symbol. Replace battery.
2.  means that voltage or current should not be more than the specified value to protect internal line from damage.
3. Set **Selector Switch** to required measuring function and range.
4. When connecting line, first connect common test line, then charged test line. When removing the line, remove charged test line first.

4.10 CURRENT MEASUREMENT



WARNING

ELECTRIC SHOCK HAZARD. REMOVE PROBE FROM METER BEFORE MEASURING WITH CURRENT CLAMP.



1. Set **Selector Switch** to position A. At this time, meter is in AC current measurement state. Choose appropriate measuring range.
2. If you want to measure DC current, press **FUNC** key to enter direct current measurement state.
3. Hold trigger, open clamp head, clip one lead of measurement circuit to be tested in the clamp.
4. Read current value on LCD display.

Note:

1. Clamping two or more leads of circuit to be tested simultaneously will not give correct measuring results.
2. To get accurate readings, connect lead to be tested at center of current clamp.
3.  indicates that maximum input AC current is 1000 A
4. To improve measurement precision, in DC current measurement state, if LCD display is not zero, press **REL** to return to zero, then measure.





4. OPERATING GUIDANCE

4.11 VOLTAGE MEASUREMENT

WARNING

ELECTRIC SHOCK HAZARD. PAY SPECIAL ATTENTION TO AVOID SHOCK WHEN MEASURING HIGH VOLTAGE. DO NOT INPUT VOLTAGE MORE THAN AC 750 RMS.

1. Insert black probe to **COM** jack, insert red probe to **INPUT** jack, choose appropriate measuring range.
 2. Place **Selector Switch** to AC voltage V or mV position. At this time, meter is in the DC voltage measurement state. To measure AC voltage, press **FUNC** key to enter AC voltage measurement state.
 3. Connect probe with voltage source or both ends of load in parallel for measurement.
 4. Read the voltage on the LCD.
- 
- 

Note:

1. In small voltage measuring range, probe is not connected with circuit to be tested and meter may have fluctuating readings, which is normal and caused by the meter's high sensitivity. When meter is connected with circuit to be tested, you will get actual measured value.
2. In relative measurement mode, automatic measuring range is invalid.
3.  Indicates maximum input AC current is 750V AC or 1000V DC Maximum input voltage is mode mV is 600 mV DC or AC.
4. If readings measured by meter are more than 750C RMS AC, a "beep" alarm will sound.



4. OPERATING GUIDANCE



4.12 FREQUENCY AND DUTY RATIO MEASUREMENT



A) Clamp head measuring frequency (through AC current):

WARNING

ELECTRIC SHOCK HAZARD. REMOVE PROBE FROM METER BEFORE MEASURING WITH CURRENT CLAMP.

1. Set **Selector Switch** to position A .
2. Hold trigger, open clamp head, clip one lead of measurement circuit to be tested in the clamp.
3. Press **Hz/%** key to switch to frequency measuring state.
4. Read current value on the LCD display.
5. Pressing **Hz/%** again enters duty ratio measuring state.

Note:

- 
1. Clamping two or more leads of circuit to be tested simultaneously will not get correct measuring results.
 2. Frequency measurement range is 10Hz~1kHz the frequency to be tested is less than 10Hz, or if frequency is higher than 10 kHz, accuracy is not guarantee
 3. Duty ratio measuring range is 10 ~ 95%.
 4. “” means that maximum input current is 1000A AC (RMS).
- 

B) In Voltage Measurement Mode:

WARNING

ELECTRIC SHOCK HAZARD. PAYSPECIAL ATTENTION TO AVOID SHOCK WHEN MEASURING HIGH VOLTAGE. DO NOT INPUT VOLTAGE MORE THAN AC 750 RMS.

1. Insert black probe to **COM** jack, insert red probe to **INPUT** jack.
2. Place **Selector Switch** to V or mV position, press **FUNC** to enter AC voltage measurement state.
3. Press **Hz/%** key to switch to frequency measuring state.



4. OPERATING GUIDANCE

4. Connect probe with signal or both ends of load in parallel for measurement.
5. VRead on LCD.
6. Pressing **H_z/%** again enters duty ratio measuring state.

Note:

1. Frequency measurement range is 10Hz~1kHz When the frequency to be tested is less than 10Hz, the LCD will show 00.0 Measuring frequency higher than 10kHz is possible, but accuracy is not guaranteed.
2. Duty ratio measuring range is 10 ~ 95%.
3.  means maximum input voltage is 750V AC (RMS).

C) In HZ/DUTY Measurement Mode:



WARNING

PAY SPECIAL ATTENTION TO AVOID SHOCK WHEN MEASURING HIGH VOLTAGE. DO NOT INPUT VOLTAGE MORE THAN AC 250V RMS.



1. Insert black probe to **COM** jack, insert red probe to **INPUT** jack.
2. Set **Selector Switch** to position **HZ**.
3. Connect probe with signal or both ends of load in parallel for measurement.
4. Read LCD.
5. Press **H_z/%** again to enter duty ratio measuring state.

Note:

1. Frequency measurement range is 10Hz~1kHz When frequency to be tested is more than 10Hz, LCD will show 00.0. Measuring frequency higher than 10 kHz is possible, but accuracy is not guaranteed.





4. OPERATING GUIDANCE





4.13 RESISTANCE TEST

WARNING



ELECTRIC SHOCK HAZARD. WHEN MEASURING CIRCUIT IMPEDANCE, DETERMINE THAT THE POWER SUPPLY IS DISCONNECTED AND THE CAPACITOR IN THE CIRCUIT IS COMPLETELY DISCHARGED.

1. Insert black probe to **COM** jack, insert red probe to **INPUT** jack.
2. Place **Selector Switch** to  position. At this time,  is in the measurement state.
3. Connect probe to the both ends of resistor or circuit to be tested for measurement.
4. LCD will show readings.

Note:

- 
1. When input end is open, LCD shows “OL” out-of-range state.
 2. When resistance to be tested $> 1M\Omega$, the meter reading will be stable after a few seconds, which is normal for high resistance readings.
- 

4.14 DIODE TEST

1. Insert black probe to **COM** jack, insert red probe to **INPUT** jack.
2. Set **Selector Switch** to .
3. Press **FUNC** key to switch to  measuring state.
4. Connect red probe to diode anode and connect black probe to diode cathode.
5. Read the LCD.

Note:

1. Meter will show approximation of diode forward voltage drop.
2. If probe has reverse connection or probe is open, LCD will show “OL”.







4. OPERATING GUIDANCE

4.15 CIRCUIT CONTINUITY TEST

WARNING

ELECTRIC SHOCK HAZARD. WHEN MEASURING CIRCUIT CONTINUITY, DETERMINE THAT THE POWER SUPPLY IS DISCONNECTED AND THE CAPACITOR IN THE CIRCUIT IS COMPLETELY DISCHARGED.

1. Insert black probe to **COM** jack, insert red probe to **INPUT** jack.
2. Set **Selector Switch** to .
3. Press **FUNC** key to switch to  circuit continuity measuring state.
4. Connect probe to both ends of circuit to be tested.
5. If resistance of circuit to be measured is less than 30 Ω , a  may sound.
6. Read circuit resistance value on the LCD.



Note: If probe is open or circuits resistance to be tested is more than 600 Ω , display will show "OL".



4.16 CAPACITANCE MEASUREMENT

WARNING

ELECTRIC SHOCK HAZARD. TO AVOID ELECTRIC SHOCK, BEFORE MEASURING CAPACITANCE, DISCHARGE CAPACITANCE COMPLETELY.

1. Insert black probe to **COM** jack, insert red probe to **INPUT** jack.
2. Set **Selector Switch** to .
3. After discharging capacitance completely, connect probe to both ends of capacitor to be tested.
4. Read capacitance on the LCD.

Note: To improve accuracy below 10nF measuring value, subtract the distributed capacitance of meter and cable.



5.0 WIRELESS OPERATION

4.17 SURGE CURRENT MEASUREMENT

WARNING

ELECTRIC SHOCK HAZARD. REMOVE THE PROBE FROM THE METER BEFORE MEASURING WITH CURRENT CLAMP.

- 4.10.1 Set **Selector Switch** to position A.
- 4.10.2 Hold trigger, open clamp head, clip one lead of measurement circuit to be tested in the clamp.
- 4.10.3 Press **REL/INRUSH** key more than 2 sec. to enter surge current measurement mode. LCD will show “- - - -”, until motor start is detected. Meter shows and keeps surge current value.
- 4.10.4 Read current surge value on LCD display.

Note:

- 1. Clamping two or more leads of circuit to be tested simultaneously will not get correct measuring results.
- 2. To get accurate reading, connect lead to be tested at center of current clamp.
- 3. In manual measuring range mode, if LCD shows “OL”, which indicates over-range, choose a higher measuring range.
- 4. In manual measuring range mode, if you do not know value to be measured in advance, choose highest measuring range.
- 5. “” means maximum input current is 1000A AC (RMS).

4.18 NCV MEASUREMENT

- 1. Turn **Selector Switch** to **NCV**.
- 2. Place meter top close to the conductor. When test voltage is greater than 110VAC (RMS) when meter is close to conductor, meter induction voltage indicator will turn on and buzzer will sound.

5.0 WIRELESS OPERATION

5.1 CONNECTION

WARNING

ELECTRIC SHOCK HAZARD. WHEN MEASURING CIRCUIT CONTINUITY, DETERMINE THAT THE POWER SUPPLY IS DISCONNECTED AND THE CAPACITOR IN THE CIRCUIT IS COMPLETELY DISCHARGED.

1. Download and open the CPS Link™ app from Apple iTunes (iOS) or the Google Play Store (Android)
2. Make sure Bluetooth is turned on your smartphone or tablet, turn on the VOLT-100 by turning the selector switch and press the blue button that says Link/REL.
3. Select the VOLT-100 icon on the app.

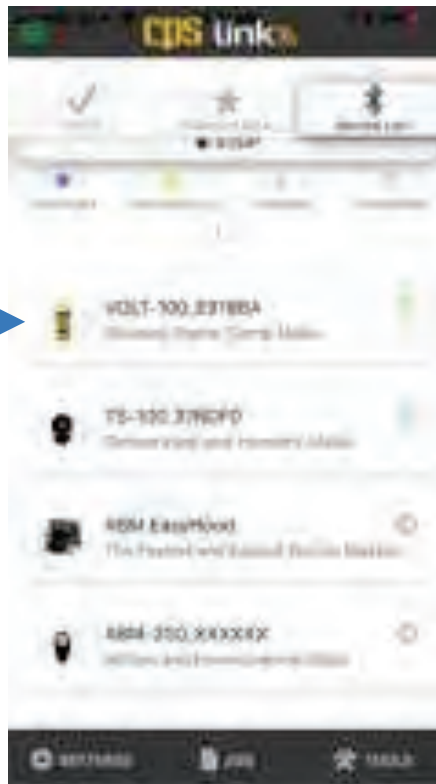

5.0 WIRELESS OPERATION

5.2 DATA LOGGING

WARNING

ELECTRIC SHOCK HAZARD. WHEN MEASURING CIRCUIT CONTINUITY, DETERMINE THAT THE POWER SUPPLY IS DISCONNECTED AND THE CAPACITOR IN THE CIRCUIT IS COMPLETELY DISCHARGED.

1. Once connected to the VOLT-100 select the TESTS tab at the top of the app and then select Data Logging.
2. The app will instruct you to press the RANGE button to begin Data Logging. The log will store the last 1,000 events.
3. Once completed, the app will automatically store the log to the smartphone or tablet and offer the opportunity to view the log onscreen or export a report in CSV format.

4

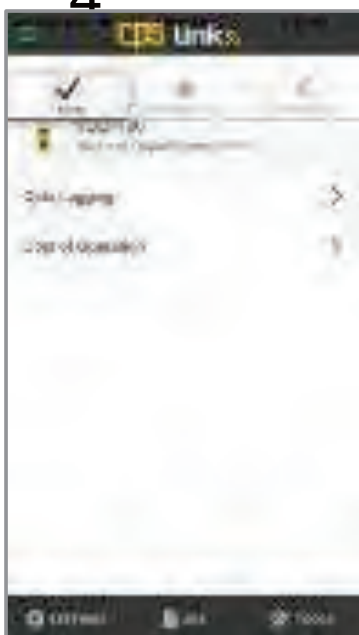

5.0 WIRELESS OPERATION

5.3 COST OF OPERATION

WARNING

ELECTRIC SHOCK HAZARD. WHEN MEASURING CIRCUIT CONTINUITY, DETERMINE THAT THE POWER SUPPLY IS DISCONNECTED AND THE CAPACITOR IN THE CIRCUIT IS COMPLETELY DISCHARGED.

1. Once connected to the VOLT-100 select the TESTS tab at the top of the app and then select Cost of Operation.
2. The app will instruct you to turn the selector dial to KW and press start to calculate the cost of operation. The app calculates the cost based on a data feed of the local utility company rate for electricity.
3. Once completed, the app will automatically store the log to the smartphone or tablet and offer the opportunity to view the log onscreen or export a report in CSV format.

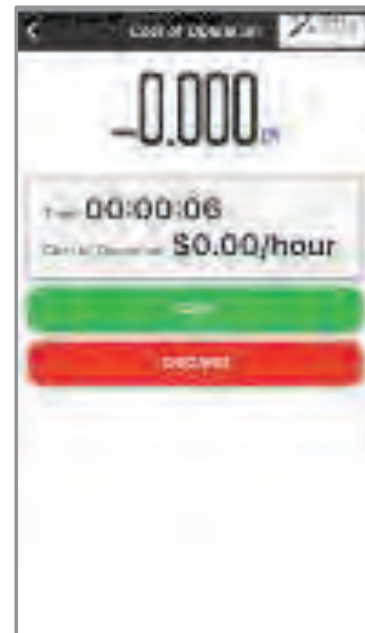



5. MAINTENANCE

Note:

1. Even if no indication, voltage may exist still. Do not use non-contact voltage detector to judge whether there is voltage in the wire. Detection operation could be affected by socket design, insulation thickness, type and other factors.
2. When inputting voltage on meter input terminal, due to existence of induced voltage, voltage induction indicator also may light.
3. External sources of interference (such as flashlight, motor, etc.) may incorrectly trigger non-contact voltage detection.

5.1 CALIBRATION

This meter should be recalibrated annually (within a temperature range of 65°F to 83°F (18°C to 28°C) and relative humidity less than 75%).

5.2 BATTERY REPLACEMENT



WARNING



TO AVOID ELECTRIC SHOCK, MAKE SURE THAT THE TEST LEADS HAVE BEEN CLEARLY MOVE AWAY FROM THE CIRCUIT UNDER MEASUREMENT BEFORE OPENING THE BATTERY COVER.



1. When  appears, battery should be replaced immediately.
2. Remove screw from battery cover.
3. Replace battery.
4. Replace battery cover and screw.

Note: Do not reverse battery polarity.

5.3 PROBE REPLACEMENT

Replace test leads if damaged or worn.



WARNING

USE MEETS EN 61010-031 STANDARD, RATED CAT III 1000V, OR BETTER TEST LEADS.



WARNING

TO AVOID ELECTRIC SHOCK, MAKE SURE THE PROBES ARE DISCONNECTED FROM THE MEASURED CIRCUIT BEFORE REMOVING THE REAR COVER. MAKE SURE THE REAR COVER IS TIGHTLY SCREWED BEFORE USING THE INSTRUMENT.



6. ACCESSORIES

6. ACCESSORIES

Description	Part #	Qty
Test Probe Set	DMXTL	1 pair

WARRANTY



CPS Products, Inc. guarantees that all products are free of manufacturing and material defects to the original owner for one year from the date of purchase. If the equipment should fail during the guarantee period it will be repaired or replaced (at our option) at no charge. This guarantee does not apply to equipment that has been altered, misused or solely in need of field service maintenance. All repaired equipment will carry an independent 90-day warranty. This repair policy does not include equipment that is determined to be beyond economical repair.

