Operation Manual

Model 340x & 340 DucTester Systems



Manual for:
Models 340x with DM32 and Model 340 with DM32 WiFi

All rights reserved.

This document contains materials protected under International and Federal Copyright Laws. No part of this book may be reproduced or transmitted in any form or by any means, electronic or mechanical, including photocopying, recording, or by any information storage and retrieval system without express written permission from Retrotec.

Retrotec makes no warranties with respect to this documentation and disclaims any implied warranties of merchantability, quality, or fitness for any particular purpose. The information in this document is subject to change without notice. Retrotec reserves the right to make revisions to this publication without obligation to notify any person or entity of any such changes.

DucTester, Infiltrometer, FanTestic are Trademarks of Retrotec. Other trademarks or brand names mentioned herein are trademarks or registered trademarks of their respective owners.

Table of Contents

Important equipment-related safeguards	8
Important occupant safeguards during testing	8
1. Why measure Duct Leakage?.....	10
1.1 Energy loss	10
1.2 Duct sealing saves money	10
1.3 Problems from duct leakage:	10
2. How much duct leakage is acceptable under existing Codes?	11
3. Model 300 / 400 System Types:.....	14
4. Types of Duct Leakage Tests	15
4.1 What is duct leakage to the outdoors?.....	15
4.2 What is duct leakage to the indoors?	15
5. Model 340 DucTesters	17
Models include US340 and EU340 with 10 inch Flex Duct	17
5.1 The calibrated DucTester fan	17
5.1.1. Range Configurations.....	18
5.1.2. Retrotec calibrated fan: Model 300.....	19
5.2 Digital Gauge	21
5.3 Flex Duct	21
5.4 Additional included duct testing components	22
5.4.1. Grill Mask for sealing registers	22
5.4.2. Umbilical for connecting fan and DM32 gauge	22

5.4.3.	Flange for connecting flex to ductwork at register	22
5.4.4.	Toolbag keeps all testing components in one place.....	22
5.4.5.	Tubing Accessory Kit	22
5.4.6.	Power Cord	23
5.4.7.	9v Power Supply adapter for charging DM32 gauge	23
5.4.8.	Additional parts and accessories for the DucTester	23
6.	Prepare for the Duct Leakage Test.....	24
6.1	Unpack, connect the gauge to the DucTester	24
6.2	Charge the gauge.....	24
6.3	Follow the Quick Guide that came with your system	24
6.4	Seal all supply registers.....	26
6.4.1.	Before beginning the duct leakage test.....	26
6.5	Make all connections on the gauge and fan.....	27
6.6	Blue Tube location matters when testing leaky ducts	28
6.7	Connect the Flex Duct to the Duct System.....	29
6.7.1.	Connect to the return register	29
6.7.2.	OR Connect to the air handler cabinet	30
6.7.3.	OR Connect to a return using a Flow Hood	30
6.8	Install Range Configuration on fan	32
6.9	Select a test direction then connect flex duct to the DucTester.....	32
6.9.1.	Blow air into the ducts for depressurization	32
6.9.2.	Blow air out of the ducts for pressurization	33
7.	Set up the gauge to display Duct Leakage Results.....	34
7.1	Mode setup for duct testing in the US.....	34
7.2	Mode Setup for various standards around the world.....	35
7.3	Setting up and using the DM32 gauge for Duct testing	35
8.	Conduct the Duct Leakage test	37
8.1	Total Duct Leakage	37
8.2	Duct Leakage to Outdoors with 2 gauges and 2 fans.....	38
8.2.1.	Method #1: Set both duct and house to -25 Pa (or 25 Pa).....	38
8.2.2.	Method #2: Set duct to house pressure to 0 Pa (using DucTester gauge)	39
8.3	Duct Leakage to Outdoors with 1 gauge and 2 fans	41
8.4	Combined Total Duct Leakage and Duct Leakage to Outdoors Method	43

8.5	If no Results are displayed (--)	44
8.6	Cannot achieve test pressure	45
9.	Restore the house to pre-test conditions after testing is complete	46
10.	Create a Duct Leakage Test Report with Potential Energy Savings	47
10.1	Get the Excel spreadsheet based software to run on your system	48
10.1.1.	Enable Macros (with Office 2007)	48
10.1.2.	Enable Macros (with Office 2010)	48
10.1.3.	Showing/Hiding the Ribbon	49
10.1.4.	Enter test information and results into green cells	49
10.2	Choose metric or imperial units for results	49
10.2.1.	Imperial units	49
10.2.2.	Metric units	49
10.3	Choose Duct Test type	50
10.4	Enter the Target test pressure	50
10.5	Enter date the test was carried out	50
10.6	Enter specific parameters for the conditions of this test	50
10.6.1.	Conditioned Floor Area	50
10.6.2.	Air Handler Flow	51
10.6.3.	Baseline pressure	51
10.6.4.	Enter whether pressurizing or depressurizing (Test direction)	51
10.7	Enter readings from this test	51
10.7.1.	Duct Pressure	51
10.7.2.	“Enter Flow directly” selection or Range Configuration selection	52
10.7.3.	Convert “Flow/Area” data so it can be entered into spreadsheet	53
10.8	Spreadsheet will calculate Cost of Duct Leakage	53
10.8.1.	% of Duct Leakage to Outdoors	54
10.8.2.	Annual Cooling Cost	54
10.8.3.	Annual Heating Cost	54
10.8.4.	Average Duct Operating Pressure	54
10.8.5.	Leakage Split	54
10.8.6.	Supply Leakage Penalty	54
10.8.7.	Return Leakage Penalty	55
10.9	Save the Duct Leakage Test Report as a PDF file	55

10.9.1.	With Office 2007:.....	55
10.9.2.	With Office 2010.....	55
11.	Find air leaks in the ducts.....	56
11.1	Using a smoke puffer.....	56
11.2	Using theatrical smoke.....	56
11.3	Using an infrared camera.....	56
11.4	Using a wet hand.....	56
11.5	Using a Pressure Pan.....	56
12.	Measure the Air Handler system flow.....	58
12.1	For Code compliance.....	58
12.2	Why measure the Air Handler system flow?.....	58
12.3	Measure with a DucTester as a powered flow hood on the return.....	58
12.4	Measure air handler flow using a blower door.....	59
12.4.1.	Supply plenum pressure matching method.....	59
12.4.2.	Set pressure in front of return register to zero method or using your Blower Door as a powered flow hood.....	61
12.5	Measure large exhaust and intake flow rates.....	62
12.6	Measure with a DucTester on the air handler cabinet.....	63
12.7	Measure with a gauge and a flow grid.....	63
12.8	Measure using air handler blower curves.....	63
12.9	Measure using Hole Flow on the gauge.....	64
12.10	Measure with a Blower Door attached to the return or cabinet.....	64
12.11	Other methods.....	64
13.	Estimate HVAC system energy loss from ducts.....	65
13.1	Duct Air Leakage Measurements.....	65
13.2	Methodology.....	65
14.	Field Check the DucTester to find out what is not working.....	69
14.1	Field Check the gauge.....	69
14.2	Field Check the DucTester as a system.....	69
15.	Avoid common mistakes.....	70
16.	Create a Blower Door with a DucTester fan.....	72
16.1	Use a DucTester to test tight enclosures.....	72
16.2	Blower Door systems for testing tight enclosures.....	72

Appendix A: Calculate Air Flow based on Channel B Fan Pressure readings.....	74
Appendix B: Flow Conversion Tables.....	75
Flow Conversion Table for Duct Test Pressure of 25 Pa.....	75
Appendix C: Calculate flow if required test pressure cannot be reached.....	76
Extrapolation Error for Flow if gauge “n” doesn’t match actual <i>n</i>	77
Cannot Reach 25 Pa Factors.....	78
Cannot Reach 50 Pa Factors.....	79
Appendix D: Troubleshooting.....	81
“--” appears on display:.....	81
Gauge “Flow” reading does not change? Turn off [@].....	81
Fan does not run.....	81
Checking the DucTester flows.....	81
Adjusting the fan Inlet Nozzle if is rubbing or debris needs to be removed from fan.....	82
Appendix E: Using a generator for power.....	83
Generators.....	84
Honda Generator EU3000 (120V, 2000W, 67 lbs).....	84
GENYX G3000HI (230V, 3000W) generator.....	84
Portable Power Supplies.....	84
Black and Decker Electromate 400 Model VEC026BD.....	84
Appendix F: Duct-Test Recording Forms.....	85
Total Duct Leakage Test Form Test date: _____/20____.....	85
Total Duct Leakage Test Form (CA) Test date: _____/20____.....	86
Glossary.....	88

Please read and save these instructions before using your DucTester:

Important equipment-related safeguards

When using electrical appliances, basic safety precautions should always be followed. If Retrotec equipment is used in a manner that does not follow the information provided in this manual, safety to the operator and equipment performance may be impaired.

- Avoid contact with moving parts.
- Special attention should be made to keep children and pets away from the fan when it is operating.
- Do not insert anything into the fan casing while the fan is moving.
- Ensure that no debris is inside the fan casing before operating the fan.
- Keep hands, hair and clothing away from fan at all times.
- The fan can cause damage or injury if it were to fall on someone/something.
- Do not use equipment for other than its intended use.
- Do not stand on the fan, or use the fan to support the weight of another object.
- To protect against risk of electric shock, do not place this equipment or power cord in water or other liquid.
- Press the power plug firmly into the power receptacle on the fan. Failure to do so can cause over-heating of the power cord and damage the fan.
- Do not use ungrounded outlets or adapter plugs. Never remove or modify the grounding prong.
- Do not operate any device with a damaged electrical cord, or after an equipment malfunction.
- Use only the included power plug to operate the fan.
- Do not run cord under carpeting. Do not cover cord with throw rugs, runners, or similar coverings. Do not route cord under furniture or appliances. Arrange cord away from traffic area and where it will not be tripped over.”
- Turn the unit off and unplug from any electrical outlet before moving and when not in use, or when making any adjustments to the fan motor or electrical components.
- For use under indoor conditions only.
- For use where there is no exposure to water or dusty substances or explosive materials or flammable materials.
- Ensure proper cooling of the fan motor.
- Equipment is intended for diagnostic testing and to be operated for brief periods under supervision by a qualified operator. Not to be used in a role as a household appliance for the purpose of moving air.
- Failure to follow these instructions carefully may result in bodily injury, damage to property and/or equipment failure. Failing to operate equipment as intended may void warranty and compliance with CE mark and other listings.

Important occupant safeguards during testing

Please read the following carefully before carrying out tests:

- If dust, pollen, mold spores, chemicals or other undesirable substances can get blown into living spaces, keep those susceptible to these substances away from the test area, and wear dust masks.

- Do not pressurize a duct system with air that is polluted or exposed to any toxic substances. For example, blowing air from a car-port into a house or duct system while a motor vehicle is running can quickly fill a house with toxic carbon monoxide.
- If combustion safety problems are found, tenants and building owners should be notified immediately and steps taken to correct the problem including notifying a professional heating contractor if basic remedial actions are not available.
- Air sealing duct work may change the pressure balance in a house and cause back drafting where it did not occur before. For example, a return leaking to outdoors may have pressurized a house but when corrected, leaky supplies may reverse that and cause depressurization which could result in back drafting hot water heaters, furnaces or fireplaces.
- Be aware of all possible sources of combustion. Ensure any appliances do not turn on during the test. Turn off power to the appliance, or set the appliance to the "Pilot" setting. It is possible for flames to be sucked out of a combustion air inlet (flame rollout) during a test, which is a fire hazard and can result in high carbon monoxide levels.
- If combustion safety problems are found, tenants and building owners should be notified immediately and steps taken to correct the problem (including notifying a professional heating contractor if basic remedial actions are not available). Remember, the presence of elevated levels of carbon monoxide in ambient building air or in combustion products is a potentially life threatening situation. Air sealing work should not be undertaken until existing combustion safety problems are resolved, or unless air sealing is itself being used as a remedial action.

1. Why measure Duct Leakage?

1.1 Energy loss

Leaky ducts pose health, safety and comfort problems and account for about 25% of the total energy lost in a typical house. Because it's *"by far the most cost effective way to save energy"* (EPA quote), building codes now demand higher performance. Although visual duct inspections may be allowed in some states, duct testing provides an easier, faster, verifiable pass /fail test result. In many instances, it has a greater impact on energy use than air leaks anywhere else in the house or building enclosure. The single largest cause of performance problems in small commercial buildings is often duct leakage.

The Duct Leakage Test Report software (in Excel) available from Retrotec can be used to estimate the energy loss from duct leakage, as described in section 10.8.

1.2 Duct sealing saves money

A study completed in Florida examined 46 homes. They found that sealing the duct leakage reduced air conditioner use by an average of 17%. This led to savings of \$110 per year, and the repairs were a onetime cost of \$200. Repeatedly, studies show that sealing leaky duct systems is one of the most cost-effective measures that a home owner can take. Heating or cooling, the same holds true in all climates. Another study in Arkansas noticed an average savings of 22% on heating bills when duct leakage sealing was performed.

1.3 Problems from duct leakage:

- Leaky return ducts pull unconditioned air into the duct system, and reduce the efficiency and capacity of the HVAC system.
- Conditioned (and expensive) air is lost directly to the outside, a crawlspace, or an attic.
- If moist air is pulled into return leaks, the dehumidification system is overwhelmed and the building will be uncomfortable.
- An inefficient duct system will result in people seeking alternative sources of heating or cooling, including increased use of electric heaters and fans.
- Dangerous gases, mold spores, insulations fibers, dust, and other contaminants can be drawn into the duct system and are blown into conditioned spaces.

2. How much duct leakage is acceptable under existing Codes?

How much duct leakage is acceptable? The table primarily shows standards for new buildings; only California has a listing for existing buildings. Changes occur as states adopt the new codes. Check at the [Online Code Environment and Advocacy Network](#) website for up to date details on energy code adoption. ENERGY STAR programs are listed even though they are voluntary programs rather than Codes.

Table 1: Duct Leakage Compliance Values (Residential) according to existing Codes

Program/Region	Units/Test Pressure	Leakage requirement
Abu Dhabi Building Code	CFM ₂₅ /100 sq ft at + 25 Pa	Total Duct Leakage: <=12 CFM ₂₅ /100 sq ft Duct Leakage to Outdoors: <=8 CFM ₂₅ /100 sq ft
CA: USA Title 24 –new building (residential)	CFM ₂₅ at + 25 Pa	Total Duct Leakage: <=6% of system air handler flow (actual measured airflow or airflow can be calculated by using the maximum of 400 CFM ₂₅ per Ton and 21.7 CFM ₂₅ per 1000 BTUh). Maximum nominal duct leakage is 24CFM ₂₅ /Ton or 1.302 CFM ₂₅ /1000 BTUh for design purposes.
CA: USA Title 24–new building (residential)	CFM ₂₅ at + 25 Pa	If testing at Rough-in without AHU Total Duct Leakage: <= 4% of system air handler flow (actual measured airflow or airflow can be calculated by using the maximum of 400 CFM ₂₅ per Ton and 21.7 CFM ₂₅ per 1000 BTUh).
CA: USA Title 24–existing building (residential)	CFM ₂₅ at + 25 Pa	Total Duct Leakage: <= 15% of system air handler flow (use actual measured airflow or airflow can be calculated by using the maximum of 400 CFM ₂₅ per Ton and 21.7 CFM ₂₅ per 1000 BTUh). OR Duct Leakage to Outdoors <= 10% of system air handler flow (use actual measured airflow or airflow can be calculated by using the maximum of 400 CFM ₂₅ per Ton and 21.7 CFM ₂₅ per 1000 BTUh). OR if fail both, show a 60% reduction in leakage
CA: USA Title 24–Ducts in conditioned space (residential)	CFM ₂₅ at + 25 Pa	If Ducts are in conditioned space Duct Leakage to Outdoors: <= 25 CFM ₂₅
ENERGY STAR Homes USA Version 3 (Rev 05)	CFM ₂₅ /100 sq ft at + or - 25 Pa	Total Duct Leakage: <= 8.0 CFM ₂₅ /100 sq ft of conditioned floor area AND Duct Leakage to Outdoors: <= 4.0 CFM ₂₅ /100 sq ft of conditioned floor area.
Florida State Energy Code FL: USA		
2009 IECC International Energy Conservation Code Global	CFM ₂₅ /100 sq ft at + or - 25 Pa	Post Construction Test: Total Duct Leakage: <= 12 CFM ₂₅ /100 sq ft conditioned floor area. OR Duct Leakage to Outdoors: <= 8 CFM ₂₅ /100 sq ft conditioned floor area. OR Rough-in Test with air handler Total Duct Leakage: <= 6 CFM ₂₅ /100 sq ft OR Rough-in Test with no air handler: Total Duct Leakage: <= 4 CFM ₂₅ /100 sq ft Required: -Where ducts are located outside the conditioned space -In existing houses where more than 50% of the ducts are replaced Not Required: - If all ducts are located in the conditioned space

Program/Region	Units/Test Pressure	Leakage requirement
2012 IECC International Energy Conservation Code Global	CFM ₂₅ /100 sq ft at + or - 25 Pa	Post Construction Test: Total Duct Leakage: ≤ 4 CFM ₂₅ /100 sq ft conditioned floor area. OR Rough-in Test with air handler Total Duct Leakage: ≤ 4 CFM ₂₅ /100 sq ft OR Rough-in Test with no air handler: Total Duct Leakage: ≤ 3 CFM ₂₅ /100 sq ft Required: -Where ducts are located outside the conditioned space -In existing houses where more than 50% of the ducts are replaced Not Required: - If all ducts are located in the conditioned space
New York State Energy Code NY: USA	CFM ₂₅ /100 sq ft Total leakage at ± 25 Pa	Total Duct Leakage: ≤ 8.0 CFM ₂₅ /100 sq ft of conditioned floor area or 6% of air handler flow. Measured at supply closest to air handler. Test equipment must be certified by manufacturer that it complies with ASTM E1554-07 and ASHRAE Standard 152. Duct leakage to outdoors acceptable under Method A of ASMT E1554-07.
North Carolina Energy Conservation Code NC: USA	CFM ₂₅ /100 sq ft Total leakage at - 25 Pa	Total Duct Leakage: ≤ 6.0 CFM ₂₅ /100 sq ft of conditioned floor area. Depressurize to -25 Pa measured at supply closest to air handler. Test equipment must be certified by manufacturer that it complies with ASTM E1554-07.
Northwest ENERGY STAR Homes ID, MO, OR, WA: USA	CFM ₅₀ /sq ft CFM ₅₀ + 50 Pa	Total Duct Leakage, air handler in un-conditioned space $CFM_{50} \leq \text{floor area (sq ft)} \times 0.04$ (which is same as $CFM_{50}/\text{sq ft} \leq 0.04$) OR $CFM_{50} \leq 50$ (when house < 1250 sq ft) OR Total Duct Leakage, air handler in conditioned space $CFM_{50} \leq \text{floor area (sq ft)} \times 0.06$ (which is same as $CFM_{50}/\text{sq ft} \leq 0.06$) OR $CFM_{50} = 75$ (when house < 1250 sq ft) Not Required: If both the ducts and air handler are located within the conditioned space
Oregon State Energy Code OR: USA		
Washington State Energy Code WA: USA	CFM ₂₅ /sq ft Total leakage at + 25 Pa	Total Duct Leakage with air handler NOT installed $\leq \text{floor area (sq ft)} \times 0.04$ CFM ₂₅ with air handler installed $\leq \text{floor area (sq ft)} \times 0.08$ CFM ₂₅ OR Duct Leakage to Outdoors (recommended where possible) $\leq \text{floor area (sq ft)} \times 0.06$ CFM ₂₅

Table 2: Maximum allowable duct leakage (Residential) according to existing Codes

Code:	Based on 2009 IECC	GA State Code	WA State Code	VT Residential Building Energy Std	ENERGY STAR Homes V3 Rev5	Northwest ENERGY STAR Homes	CA Title-24 Code – Altered ducts	CA Title-24 Code – New ducts	Based on 2012 IECC
Region:	AL CT DC DE FL IA ID IN KY MA MI MT NC NE NH NJ NM NV NY OH OR RI SC VA	GA	WA	VT	USA	ID OR MO WA	CA	CA	MD
Test Pressure	± 25 Pa	± 25 Pa	+ 25 Pa	± 25 Pa	± 25 Pa	+ 50 Pa	+ 25 Pa	+ 25 Pa	± 25 Pa
Units	CFM /100 sq ft	CFM /100 sq ft	CFM /sq ft	CFM /100 sq ft	CFM /100 sq ft	CFM /sq ft	CFM	CFM	CFM /100 sq ft
Max Total Duct Leakage, at rough in, NO air handler	4	N/A	0.04	4	N/A	N/A	N/A	4% of system airflow	3
Max Total Duct Leakage, at rough in, with air handler	6	6	0.08	3	N/A	N/A	N/A	6% of system airflow	4
Max Total Duct Leakage, post construction with air handler	12	12	0.08	N/A	8	0.06 CFM/ sq ft or 75 CFM	15% of system airflow	6% of system airflow	4
Max Duct Leakage to Outdoors, post construction with air handler	8	8	0.06	6	4	N/A	10% of system airflow	N/A	N/A







The table is listed from left to right in order of loosest to tightest “Total Duct Leakage” requirements.

Disclaimer: This information is not guaranteed. As Codes are being updated continually, this table represents the most up to date information available at the time of publishing. Please refer to “rev” date on cover page of this document to determine date of publishing.

3. Model 300 / 400 System Types:

The Model 340 shares its body and inlet nozzles and Flow Plates with several other models as shown below. Each one is specialized for a certain application. The Model 340 is used primarily in the US for relatively leaky US made ducts. The Model 350 is for tighter European ducts that often have to be 100 times tighter than US ducts. The Model 300 is simply the same fan but attached to a door panel for testing tight houses, apartment, rooms or enclosures. The Model 450 is meant exclusively for testing commercial ducts at 10 to 100 times the test pressure used for US residential duct that are tested at 25 Pa normally and sometimes 50 Pa. the Model 451 has 10 times the power and is much heavier than the 340 but still a fraction of the old fashioned Commercial duct testers in common use.

This manual focuses on the Model 340. Be sure to refer to the Quick Guide that came with your system or can be obtained at: <http://retrotec.com>

340x	350x	300x	440x/450x
			
<p>The US DucTester system is powerful enough to test leaky ducts found in old homes and tight ducts in new homes.</p>	<p>'European DucTester' tailored for airtight European ducts. Just add the aluminum frame to test houses.</p>	<p>The Model 300x is ideal for testing tight houses as large as a 1600 square feet of floor area that leak as much as 3 Air changes per Hour.</p>	<p>Commercial duct testing up to 20 in WC (5000 Pa) in a compact package.</p>

4. Types of Duct Leakage Tests

Air leakage from a duct system can be very hard to identify. Most duct systems are predominantly behind walls, in attics, crawlspaces, or other unconditioned and hard to access areas. Consequently, most duct leaks are hard to find, and tend to go unnoticed by owners and contractors alike. Unfortunately, the harder a leak is to find, the more crucial it tends to be, as these leaks are often found in hot, humid, damp, and moldy environments. For more details on methods of finding air leaks in the ducts, refer to later sections.

There are two types of duct leakage tests: a Total Duct Leakage test, and a Duct Leakage to the Outdoors test.

Total Duct Leakage test is used to determine the total amount of air leakage from a duct system (to outdoors and indoors)

- only a DucTester system is needed to create a pressure in the duct system
- See section 8.1 for test procedure

Duct Leakage to Outdoors test is used to determine the air leakage from a duct system to the outdoors only

- Both a DucTester system and a Blower Door system are needed in to create a pressure in the duct system and the house
- See section 8.2 for test procedure

4.1 What is duct leakage to the outdoors?

Duct systems can be either within the conditioned space (i.e., entirely enclosed in the building), or outside of the building envelope (i.e., in crawl spaces and/or attics). When ducts are contained in the conditioned space, air leaking from ducts will end up inside the home. When the ducts are outside of the conditioned space, duct air leaks go directly to the outdoors; this causes conditioned supply air to escape, and allows outdoor air to be sucked in through the return. If duct systems run within building cavities, leaked air can go to both the outdoors and inside the house.

For Duct Leakage to Outdoors tests, the DucTester fan and Blower Door create the same pressure in the house and the duct system. This neutralizes the pressure between the house and duct system, which effectively means that there would be no airflow between the duct and inside the house, resulting in the DucTester system only measuring duct leakage to the outdoors.

The studies discussed in section 1.2 mostly reference homes with duct systems outside of the conditioned space. Duct leakage to the outdoors has the most impact on HVAC performance. However, even when all ductwork is located within the building there can be significant loss to the outdoors.

4.2 What is duct leakage to the indoors?

Less is understood about the impacts of duct leakage to the indoors. One of the major concerns is that leaky return systems can cause basements to depressurize, which can in turn cause combustion gases (from the furnace) to spill into the home. This can cause serious health problems for the occupants, especially if the gas mixture is high in carbon monoxide, an odorless, invisible gas and deadly gas. Along with this problem, negative pressures can also cause increased moisture in the building, and possibly allow radon gas to infiltrate as well.

This is a schematic of a duct leakage test. Registers are sealed, the duct tester fan is connected to a return and the pressure gauge picks up the pressure in the ducts.

Locate the step by step Quick Guide that came with your equipment or access it at www.retrotec.com.

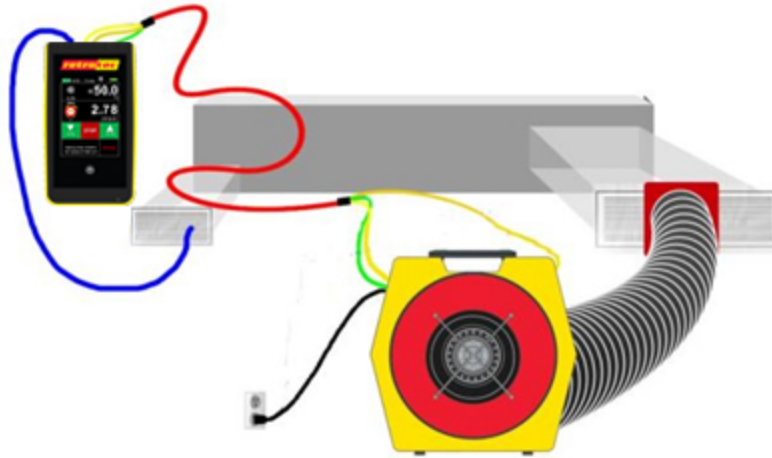

Figure 1: DuctTester setup, including tubing locations and necessary connections.

5. Model 340 DucTesters

Models include 340x 340 with 10 inch Flex Duct

A complete DucTester includes a calibrated fan, a digital dual-channel Model DM32 digital touch screen pressure gauge, and a Flex Duct with flange to attach the fan to a register. Systems also include a hard-sided fan case, an AC adaptor for the gauge, and a roll of Grill Mask. All pressure tubing and Control Cables are bundled together securely in one easy to use Umbilical cable (included), and the included tubing accessory kit contains T connectors and tube lengths for other non-typical tasks.



Figure 2: A complete duct testing system.

5.1 The calibrated DucTester fan

Retrotec's DucTester was specifically designed for testing ducts and tight enclosures. It has more than three times the power necessary to test the leakiest duct system to current standards. The backward curved centrifugal impeller is perfect for creating high test pressures. The elliptical nozzle is extremely stable in both the pressurization and depressurization test directions, where it offers equivalent accuracy in both directions.

A Flow Conditioner is not needed with Retrotec fans for depressurization testing. Some duct testing fans require a flow conditioner when depressurizing a duct system, in order to get correct readings. The Retrotec DucTester does not require a flow conditioner because it uses a flow nozzle, which is intrinsically stable in either direction because the flow gets compressed as it goes through the nozzle.

All Retrotec models comply with ASTM E1554-07, ANSI/ASHRAE 152, ASTM E779-10, EN 13829, ATTMA TS-1, CGSB 149.10 and RESNET standards.

The DucTester Fan can be used as part of a Blower Door system for testing tight enclosures, as shown in section 16. For procedures on how to test an enclosure using a Blower Door system, see *Residential Pressure & Air Leakage Testing Manual* and/or the *Blower Door Operation Manual* from the Retrotec web site. You can also search on blower door as a tag to find these manual, guides and videos on the website also.

5.1.1. Range Configurations



Figure 3: Open Range is for the leakiest ducts and houses while Ranges 74, 47, 29 are for progressively tighter ducts.

All Retrotec calibrated fans have multiple Range Configurations in order to measure a wide range of air leakage flow rates. Select the correct Range Configuration by running the fan speed up to ensure it is running at over 50% speed and the gauge is giving a flow result. If not change to a lower range and repeat.

A calibrated fan measures flow by measuring the pressure developed inside the fan, which is often called Fan Pressure. As the fan speeds up, a suction pressure develops at the inlet of the fan that causes air to flow. By measuring this Fan Pressure, airflow is calculated using flow equations that are inside the Retrotec gauge and FanTestic software.

When the fan slows down, the Fan Pressure can become too small to accurately measure flow. To increase the Fan Pressure, a restriction plate is placed in front of the fan. The fan, consequently, has to turn faster to maintain the same room or duct pressure, which creates a larger, more accurate Fan Pressure. By providing a set of flow restricting plates with calibrated holes, Retrotec DucTester fans can measure flows from 0.005CFM to 800 CFM.

The Model 300 has 4 standard Range Configurations: Open, 74, 47 and 29. Open range is accessed by removing the cover over the fan inlet called End Plate 300. The numbered Ranges are 4 inch Plugs that snap into the End Plate and will restrict the flow to allow you to measure lower flow rates. The numbers refer to the approximate hole diameter in millimeters. Most residential ducts in new homes can be tested using Range 47. Older existing houses can be tested using Range 74 and super tight ducts on Range 29.

When depressurizing, the Flex Duct must be removed in order to change the Ranges.

Refer to the DM32 Flow Calculator on retrote.com for Range Plug flow capacities.

5.1.2. Retrotec calibrated fan: Model 300

The Model 300 fan has 0.25 hp backward curved impeller that uses 48 Volts that comes from the supplied power supply. Any input voltage from 100 to 280 Volts AC, 50 to 60 Hz is acceptable. Speed is controlled using the knob on the 300 fan or the Retrotec digital gauge, which will control the fan to any desired Set Pressure or Set Speed.

The Model 300 Fan has a speed control built into the Fan Top with a power input connection, a speed control knob, an on/off switch, and the Fan Pressure fittings all on one Control Panel. Two CAT-5 connectors are used to connect to any Retrotec gauge for speed control purposes; not to be connected to the Internet. The second CAT-5 connection allows this fan to be daisy chained to a second fan, making them receive the same % speed signal thereby making two fans run in unison. The control signal from one gauge will run both fans.



Figure 4: Retrotec Model 300 has a speed control knob and two Ethernet style Speed Control Ports for daisy chaining speed controls for running many fans together. The yellow and green color coded tubing connections to the gauge are shown.

The Model 300 has 4 Flow (Fan Pressure) sensors located inside the fan inlet, and 4 self-referencing pickups located just above and below the fan inlet which are connected to the single green and yellow ports.



Figure 5: Fan Pressure sensors are located in the fan inlet.

The 4 Flow sensors are located just inside the fan inlet, behind the protective grill. Together, they measure the Fan Pressure, from which the fan airflow is calculated in the gauge. If the sensors become

blocked, it is possible to clear them by attaching a pressure tube to the yellow Ref B port, and blowing air through the tube gently.

The exterior of the inlet has the 4 self-referencing pressure pickups. They are connected to the green Input B port, and are used as the reference for the Flow (Fan Pressure) Sensors. Self-referencing ensures that the measured pressure difference is always accurate, no matter what the direction of flow is with respect to the location of the gauge and operator and whether or not a flex duct is attached to the inlet of the fan or not.

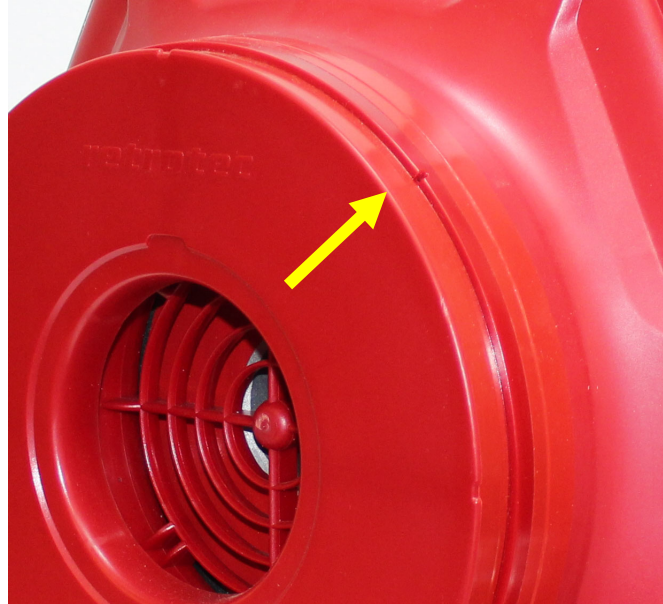

Figure 6: Self-referencing pressure pickup.

5.2 Digital Gauge



Figure 7: DM-32 digital gauge.

Model 340 use the DM32 gauge while Model 342 signifies the WiFi enabled gauge that works exactly the same in every other respect.

The latest Retrotec Digital Gauge is included with all Retrotec DucTester systems. The gauge can be combined with the Model 300 fan for automatic control to Set Pressure or Set Speed. The gauge is a dual-channel manometer, which can automatically convert the measured Fan Pressure into a range of useful results that meet every major testing standard in the world.

The gauge is also capable of taking a Baseline pressure reading, and automatically recalculating results, in order to reflect this bias pressure. It can auto zero itself to ensure pressure readings do not drift away from the true pressure value during a test. It is also capable of displaying results that are extrapolated to any pressure.

For more information on configuring and using the DM-32, see the *DM-32 Operation Manual*.

5.3 Flex Duct

Retrotec's duct testing systems US340 and EU340 include a 10" diameter, 12' long flexible duct to connect the fan to a register, or duct system. A durable plastic Flange on one end is taped to a register or air handler, and connected to the Flex Duct to ensure a strong and simple seal. Velcro straps on either end securely attach the Flex Duct to the Flange and fan inlet or outlet.



Figure 8: Flex Duct for duct testing system with Flange and strap.

5.4 Additional included duct testing components

In addition to the calibrated fan and digital dual-channel pressure gauge, a Retrotec DucTester system includes a few additional items.

5.4.1. Grill Mask for sealing registers

Grill Mask is used to seal over registers and vents. Grill Mask comes in a 12" wide roll. It is perforated at 12" intervals to provide easy-to-tear pieces that can seal nearly anything. Be careful applying Grill Mask to painted surfaces, as paint can be pulled off when removing it after testing. Additional Grill Mask can be ordered from Retrotec as a single roll or in three roll bundles. A handy Grill Mask dispenser is also available as an optional accessory.



5.4.2. Umbilical for connecting fan and DM32 gauge

An umbilical neatly bundles the needed pressure tubes and Control Cable, to prevent the user from being greeted by a tangled mess of tubes and cables before each test. The standard 20' long DucTester umbilical includes a yellow, green, and blue pressure tube, as well as the Control Cable used for the DM32 to communicate with the fan. For detailed instructions on how to connect the DucTester fan and the DM32 gauge using the Umbilical, refer to section 6.1.



5.4.3. Flange for connecting flex to ductwork at register

The Flange is the intermediate part used to secure the Flex Duct onto a return register by using masking tape or Grill Mask. For instructions on how the Flange is connected, refer to section 6.6.



5.4.4. Toolbag keeps all testing components in one place

The Deluxe Cordura Tool bag provides enough volume to hold all the system components of a DucTester System. It includes a shoulder strap for easy carrying. The vented exterior pocket is an important feature, useful for storing your smoke puffer which will destroy your gauge and laptop if stored together.



5.4.5. Tubing Accessory Kit

The Tubing Accessory Kit comes with blue pressure tubes. Attaching a Static Pressure Probe to the pressure tube can prevent pressure reading interferences from wind or other air flows blowing on the pressure tube. The metal tube can be passed through a small such as under a door or window to prevent the tube from being pinched, and affecting the pressure reading.



5.4.6. Power Cord

The power cord is used to power your Model 300 fan. Once it is connected to a wall outlet, the Mains Power status light turns green, indicating power is connected.



5.4.7. 9v Power Supply adapter for charging DM32 gauge

A battery charger is included to charge the DM32 gauge's batteries. For instructions on charging the DM32 batteries refer to the DM32 Manual.



5.4.8. Additional parts and accessories for the DucTester

6. Prepare for the Duct Leakage Test

6.1 Unpack, connect the gauge to the DucTester

Prior to beginning any test, it is important to verify that the system is functioning properly. Check that the batteries have enough power, and that the fan can be controlled either automatically or manually.

6.2 Charge the gauge

The batteries should be charged when you first get your gauge but we advise you to leave your gauge on the charger overnight to make sure. These rechargeable batteries are just like the ones used in Smart Phones and will save you about \$300 per year over old style alkaline disposable batteries, so it's worth having a charger with the equipment and one in your vehicle. Battery life is about 11 hours on a single charge with WiFi disabled. Battery life is about 9 hours on a single charge with WiFi enabled.

The batteries will charge more quickly if the DM32 is turned off and when plugged to a wall outlet (instead of to a computer). A large battery icon (shown below) will be displayed on the screen when your battery is receiving a charge. When plugged into your computer, the battery will not get drained but will not charge up completely either. Running FanTestic software is better done wired for this reason as well as because it's a faster more stable connection.



Figure 9: The screen of the DM32 while the batteries are being charged.

6.3 Follow the Quick Guide that came with your system

.... take the online training course then try a test on your own house before contacting support. You will learn faster this way.

The Quick Guide is intended to walk you through the test Step by Step. Check it off as you go. Use this manual for additional guidance. You can also watch the videos on the Retrotec website and take the on-line training course. You can also download this from the Retrotec Website. Look under the Model 340x under Products and look for the *Quick Guide / Manual* tab.

Retrotec's Model 340x

Residential DucTester QuickGuide

rev 2019-04-27



1 Prepare the ducts and house

Refer to your "Gauge Quick Guide" and become familiar with its operation before performing a test.

Check boxes (☐) for each step.

- Turn off air-handlers or adjust temperature so the unit will not turn on.
- Seal all supply and return grills/registers, including any exterior air inlets, with Grill Mask, plugs, covers, or tape.

See: "Residential Duct Testing Manual" for additional information. Download it from: www.retrotec.com

1 Prepare the ducts and house (cont'd)

- Remove all air filters
- Open all interior doors leading to rooms containing a supply or return register.
- Open an exterior door or window.



6.4 Seal all supply registers

Preparing for a duct leakage test requires preparing both the duct system and the building. The following setup procedures are recommended by Retrotec. If the test is being conducted according to a specific program guideline, you may be required to set up the duct system and building differently than what is described below.

6.4.1. Before beginning the duct leakage test

1. Adjust the HVAC system controls to ensure that the air handler does not turn on during the test.
1. Remove all filters inside the ductwork including any filter that is behind the return grill (that the DucTester will be connected to).
2. Seal off all remaining supply and return registers using Grill Mask. A roll is provided with all DucTester systems.



Figure 12: Turn off the air handler



Figure 10: Seal all supply and return registers with Grill Mask



Figure 11: Remove all air filters

While it would be ideal to seal between the register and the wall using Grill Mask, caution must be used to prevent pulling paint off the wall.

3. Seal combustion air and ventilation inlets directly connected to the duct system. This can be done by sealing the opening on the outside of the building, but can also be done by removing the inlet from the duct work and taping off the opening.
4. Turn off all exhaust fans, dryers, and room conditioners.
5. Turn off vented combustion appliances, if there is a possibility that the area containing the appliance will become depressurized during the testing procedure.
6. Open all interior doors leading to rooms containing a supply or return register (and open an exterior door or window for a Total Duct Leakage test – see section 8.1). When ducts run through an unconditioned space, that space must also be opened to the outdoors, to relieve any pressure that may build up in that space during the test.



**Optional
Vent Cap
register
sealing**

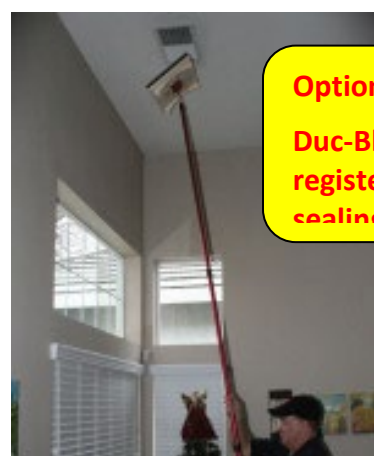

**Optional
Duc-Bloc
register
sealing**

6.5 Make all connections on the gauge and fan

1. Often, the yellow, green and blue tubes and the Control Cable are left permanently connected to the gauge but if not, make those connections.



Figure 13: Pressure ports on the top of the gauge are color-coded to match the tubing.



Figure 14: Electrical connections on the bottom of the gauge include Network (Ethernet) Cable that goes from the DM32 to a PC (if Retrotec PC software is used for data collection), micro USB cable for PC software and/or charging, and a reset button.

2. Connect the power cord to a wall outlet and to the fan. Turn on the power switch. The Mains Power status light turns green, indicating power is connected. Before connecting the Control Cable, the manual speed control knob can be used to test run the fan. If the Control Cable is connected it must be disconnected to use the Manual Speed Control Knob. The Manual Speed Control Knob must be turned to zero and back on again to re-activate it.



Figure 15: Model 300 Fan Top houses the speed control, control knob, power connection, color-coded tubing connections (green and yellow) and Control Cable.

3. Connect the Control Cable to the fan, unless you wish to use the Manual Speed Control Knob. When the Control Status light is illuminated solid green, this means the fan is connected to the gauge and is ready to perform automated testing. Having the Speed Control Cable connected disables the manual Speed Control Knob. To enable the manual

Speed Control Knob, disconnect the yellow Speed Control Cable and turn the knob on, off and on again.

4. Connect the yellow and green tubes on the fan.
5. Insert the blue tube into the duct system, typically through a supply register closest to the air handler or into the supply plenum itself. Attaching a Static Pressure Probe to the blue tube is mandatory when connecting to the plenum to avoid the effects of the moving air (velocities) to be found there. While not necessary when connecting to registers since there is almost no velocity there, it makes a handy method to pierce the tape and hold the blue tube in place.



Figure 16: Insert the blue tube into a supply register closest to the air handler

6. If the rechargeable batteries in the DM32 are below one quarter power, the battery charger should be connected to the micro-USB port on the DM32. Charge them fully overnight.
7. To test control of the fan, press **[Set Speed] [20] [Set]** on the DM32. This sets the fan to 20% speed. The preferred method is using **[Set Pressure] [25] [Enter]**. (Some standards require 50 Pa).
8. Press **[Stop]** to stop the fan.

For details on DM32 operation, see [DM32 manual](#).

6.6 Blue Tube location matters when testing leaky ducts

When measuring extremely leaky duct systems (where the leakage is over 500 CFM), the location of the test measurement point has a significant influence on the measured results because the test pressure induced in the duct system will vary throughout the system.

The highest leakage results will likely be measured when the blue tube is put into the supply register that is furthest from the air handler. Conversely, putting the blue tube into the main supply trunk line, or supply plenum, will measure lower leakage results. Measuring with the blue tube at the return ducting, where the DucTester is normally attached, will show the lowest possible leakage results.



Figure 17: A Static Pressure Probe attached to a pressure tube allows the measurement of pressure without flow interference (e.g.: inside a supply

Some programs require test results from two test measurement locations. The two results are averaged, which helps eliminate error due to the location of the test measurement point.

In duct systems that are relatively tight (200 CFM or less), the induced test pressure in the system is more uniform, and all locations will provide similar results. Essentially, if a duct system passes an energy code requirement of 100 CFM or less, the test point location will not affect results in any significant way.

New home testing is typically done using the register closest to the supply plenum which is just fine most of the time. If the system is too leaky to pass, try placing the blue tube in the return plenum; if the reading is about the same, the leaks are in the return, if the leaks are a lot less, they are in the supply.

If you have a Blower Door and a pressure pan, pressurize the house to 50 Pascals and then take pressure readings on the pressure pan, with the pressure pan closing off one register at a time. The leakiest ducts will be found behind those registers with the highest pressures.

6.7 Connect the Flex Duct to the Duct System

The DucTester has a 10 inch by 12 foot Flex Duct with a Flange on one end which is normally connected a return grill, but which can also be connected to the air handler cabinet. When considering where to connect the DucTester to the duct system, it is important to think about airflow restriction and accessibility.

6.7.1. Connect to the return register

For most duct tests, the DucTester should be connected to the central return (if there is one) or to the air handler cabinet itself. If there are multiple returns in a duct system, the return duct work is typically smaller in size and can cause restrictions in airflow that can create backpressures and contribute to poor and inaccurate test results. If the air handler is in a difficult location for access (i.e., in the attic or crawl space), find the closest, largest return grill to the air handler and use that.

7. Choose the main return with the most direct connection to the air handler. Remove filters behind the return grill.
8. Attach the Flange to the return grill using Grill Mask or high quality masking tape. Seal the remaining openings with Grill Mask.
9. Attach the open end of the Flex Duct to the Flange (which is attached to the return grill); use the Velcro strap to secure it to the Flange.
10. Place the DucTester in such a position as to minimize any major bends in the Flex Duct.



Figure 19: Flange taped onto a return register before attaching the Flex Duct



Figure 18: Flex Duct connected to the Flange.

6.7.2. OR Connect to the air handler cabinet

Alternatively, connect a Flex Duct to the air-handler cabinet. Normally this will give the same results as connecting to a return. In cases where there is no return ducting installed, or where leaks in the return system are excessive, connecting to the air-handler might be the only option to measure the supply section of the ducts.

11. Cut a piece of cardboard the same size as the access panel to the blower compartment of the air handler unit. Cut a hole in the Range 74dle of the piece of cardboard that is slightly smaller than the square Flange.
12. Put the cardboard piece with the attached Flange onto the opening of the blower compartment access. Tape the cardboard in place and seal all four sides of the cardboard panel.
13. Attach the Flex Duct to the Flange and secure it with the Velcro strap. Ensure that the DucTester has been placed in such a position as to minimize any major bends in the Flex Duct.
14. Select a location to measure the test pressure that is induced by the DucTester. This induced pressure will be measured on Channel A of the gauge.



Figure 20: Preparing to connect to ducts via air handler

6.7.3. OR Connect to a return using a Flow Hood

The optional Flow Hood is a faster way to connect to a ceiling register. Here the system is being pressurized from a ceiling level return. It is a Pressure Pan with a hole in it, pre-cut to fit the Flex Duct and a Flange. The blue tube goes into the supply register closest to the air handler just as before.

Optional Flow Hood connector shown.

When pressing the Flow Hood over the ceiling register, precautions must be taken to prevent the black rubber weather-strip from marking light colored walls. Either cover the rubber with clear tape, or avoid scraping over the painted surface.

Before the registers are covered, and while the air handler is running, the system's air handler flow rate can also be measured up to the capacity of the DucTester. For detailed instructions on how to use a powered Flow Hood to measure system air handler flow, refer to section 12.3.

Higher air flow rates can also be measured when connected to the air handler itself because then the exclusive @Pressure feature on the Retrotec gauge can be used to establish an exact flow rate at any required pressure.





**Optional
Sierra Building
Science device
for connecting
flex to return.**



**Optional
Vent Cap
device for
connecting flex
to return.**

6.7.4. What about pinholes or other leaks in the flex?

One question we get a lot is about leaking flex duct that connects the DucTester to the return. I just tested the most ripped up flex I could find on optional low flow Range 7; I had way bigger than pinholes and it measured 0.68 CFM at 25 Pa. When you measure a typical leakage of 100 CFM at 25 Pa or more, this is not even 1% so it is not worth spending money on replacing.

You can create your own inexpensive version of Range 7 by covering the front of your DucTester with grill mask and putting a quarter inch square hole in it. Set your DucTester to Range 7 on Device 340, seal off the end of your flex and measure the leakage. If you get more than 3 CFM you might start to worry about it. Range 7 is available on the Model 340 but this test should show you don't need it.

6.8 Install Range Configuration on fan

Each Retrotec DucTester includes three Range Configurations to maximize accuracy and versatility: Open, 74, 47 and 29 as standard. The selected Range Configuration will determine the range of air flow that the DucTester can measure. While it is easy to change the Range Configuration when pressurizing, it is better to make your best guess at the correct Range Configuration when testing in the depressurization direction since the Flex Duct must be removed to change Range Configurations. Do NOT try to forcefully attach the Range Rings to the exhaust; they must always go on the inlet of the fan.



Figure 21: Inserting a range plug into the end plate.

Use a Range with a larger opening for leakier ducts and smaller opening for tighter ducts. Testing should always be done at the highest possible fan speed, which means using the most restrictive Range Configuration possible (the one with the smallest hole possible). Higher fan speeds lead to the highest degree of accuracy. If the fan is running too slowly, “-----” will appear on the DM32 gauge display indicating you must change to a more restrictive range.

6.9 Select a test direction then connect flex duct to the DucTester

Duct leakage can be measured by blowing air into the ducts to pressurize the ducts, or by pulling air out of the ducts to depressurize the ducts. Program guidelines may specify a particular test direction. Both test directions provide similar results, however depressurization testing is faster and more consistent because the negative pressure will pull the Grill Mask (or other sealing means) onto the registers ensuring a tighter seal. In the absence of any other requirement, Retrotec recommends depressurization. Some standards require pressurization.

6.9.1. Blow air into the ducts for depressurization

1. Install Range 47, since most systems can be tested on this Range Configuration. For more information about selecting and changing Range Configurations, refer to section 6.8.
2. Install the Flex Duct over the fan inlet, covering the Range Rings and tighten the strap.



Figure 22: Install Flex Duct over the fan inlet, covering the Range Rings, for depressurization. Tighten the strap.

The optional quick connect collar is demonstrated on the left whereas the standard system has the flex connect directly to the Model 300 fan shell.

6.9.2. Blow air out of the ducts for pressurization

The only advantage of pressurizing is that it makes changing Range Rings on the fan easier. If a pressurization test is needed, simply install the Flex Duct on the outlet side of the fan.



Figure 23: Install Flex Duct over the fan exhaust, for pressurization. Tighten the strap.

7. Set up the gauge to display Duct Leakage Results

Read the Total Duct Leakage results directly from the gauge. Change units by tapping on Channel B. In order to compare duct systems in different homes/buildings, it is necessary to normalize the leakage results for the size of the HVAC system and the size of the building. The two most common variables used to normalize duct leakage are total HVAC flow rate and the floor area of the building.



Figure 24: Some of the most common results that can be read directly off the gauge.

7.1 Mode setup for duct testing in the US

The Table below shows what settings will directly calculate the results required for testing compliance with the codes adopted in the various states.

Table 3: Gauge Mode Setup for US state Codes and programs for Duct Testing

Code	2009 IECC	ENERGY STAR	Northwest ENERGY STAR Homes	Title-24 Code	WA State Code
Region:	VT GA CT DE GA ID IL IO MA NC NH NJ NY OH TX MD	USA	ID MO OR WA	CA	WA
Pressure	Pa	Pa	Pa	Pa	Pa
Flow	CFM	CFM	CFM	CFM	CFM
(Flow) @ Pressure	@25 Pa	@25 Pa	@50 Pa	@25 Pa	@25 Pa
Flow per Area of Conditioned floor area	CFM/100 ft ²	CFM/100 ft ²	CFM/ft ²	Off	CFM/100 ft ²
(Flow per Area) @ Pressure	@25 Pa	@25 Pa	@50 Pa	Off	@25 Pa

Grey areas in the table indicate those results are not needed for those programs but can be turned on or off any time they may be needed. The “@ Pressure” value for Flow measurement is set at the value required for duct testing.

7.2 Mode Setup for various standards around the world

Table 4: Gauge Mode Setup for various standards around the world

Standard:			
Region:	France Res	France Apt	France CommI
Pressure	Pa	Pa	Pa
Flow	m3/hr	m3/hr	m3/hr

7.3 Setting up and using the DM32 gauge for Duct testing

3. Set up the gauge to show the results you require

Tap **[Channel B]** on the screen to select a different Result, or tap the **[Result to be displayed]** button in the **[Settings]** menu. Typically, choose between Flow or Flow/Area.

Units for flow are typically CFM, and units for Flow/Area are typically CFM/ft², CFM/100 ft², or CFM/1000 ft².

If Flow/Area is the Result is selected, the **[Area]** button will be appear on the Home screen. Tap the **[Area]** and enter a value to change the area in units of sq ft. The **[Area]** can also be changed from the **[Settings]** menu.

4. Set up the gauge to show only the fans and ranges you need, and set the ones currently in use

Press the **[Device]** button (fan icon from the Home screen) and select **[340]**.

Next, select Range Configuration **[74]**. If Range Ring installed on fan is not Range 74-Range, adjust the setting on the gauge to match what is installed.

5. Set up the gauge for proper time averaging.

Press the **[Settings]** button and toggle **[Time Averaging]** to get "4s", or go to 8 seconds if results are fluctuating.

6. Adjust fan speed on DucTester

Use **[Set Pressure]** on gauge: Press **[Set Pressure]** on DM32 gauge's Home Screen, then **[25]**, **[Set]**. The fan will automatically accelerate and maintain a pressure of 25 Pa in the duct system. Press **[@]** button until "@ is ON" is displayed to view the result at exactly 25 Pa. If your standard requires 50 Pa, change the **[Default @ Pressure]** to 50 Pa from the **[Settings]** menu.

OR

Use **[Set Speed]** on gauge: Press **[Set Speed]** on DM32 gauge's Home Screen, then **[50]**, **[Set]** to set the fan speed to 50%. Press **[▲]** or **[▼]** buttons to adjust the speed until Duct Pressure (Channel A) displays close to 25 Pa. Press **[@] button** until "@ is ON" is displayed to view the result estimated at 25 Pa. If your standard requires 50 Pa, change the **[Default @ Pressure]** to 50 Pa from the **[Settings]** menu.

OR

Use the manual Speed Control Knob on the Fan Top. Increase the fan speed until a stable pressure of 25 Pa (or -25 Pa) is displayed for Duct Pressure (Channel A). Press **[@]** button until “@ is ON” is displayed to view the results at exactly 25 Pa. If your standard requires 50 Pa, change the **[Default @ Pressure]** to 50 Pa from the **[Settings]** menu.

7. If "--" appears as the flow result, or the desired test pressure cannot be reached, change the Range Configuration on the fan and on the gauge to match (see section 6.8).



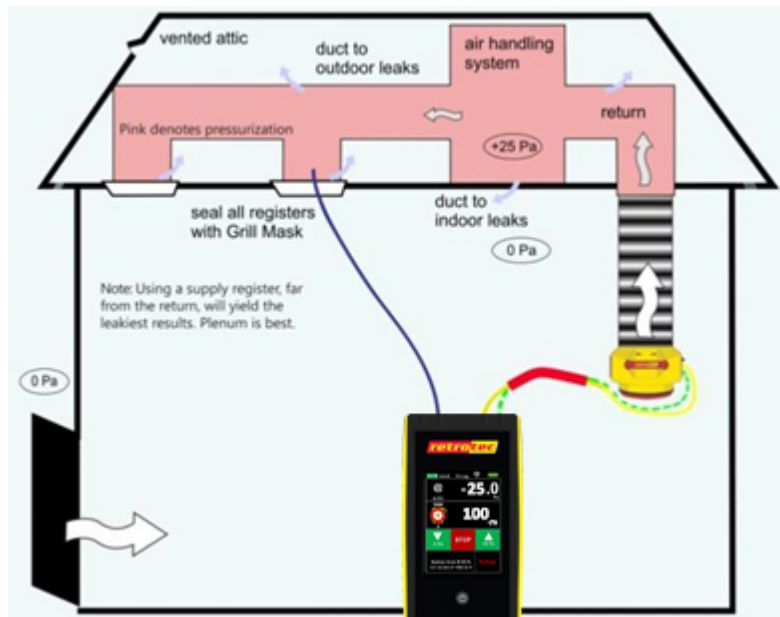

Figure 26: Total Duct Leakage under pressurization - DucTester and tubing setup.

8.2 Duct Leakage to Outdoors with 2 gauges and 2 fans

A Duct Leakage to Outdoors Test neutralizes the duct leakage to the house (or conditioned spaces) by pressurizing the house to the same pressure as the ducts. The measured duct leakage thus only reflects the leaks to outdoors.

If a green, self-referencing, pressure port is available on the Blower Door fan, use the green pressure tube to connect it to the Blower Door gauge, and ensure the Device chosen on the gauge is "Retrotec 3000SR".

8.2.1. Method #1: Set both duct and house to -25 Pa (or 25 Pa)

Method 1 allows the @ Pressure extrapolation function to be used, increasing accuracy and allowing the test to be carried out with a single setting for the DucTester and Blower Door gauge. No changes need to be made on the DucTester gauge from the Total Duct Leakage Test, which is convenient if you have to carry out both tests.

8. Complete the previous Total Duct Leakage test.
9. Ensure all doors and windows are closed and exhaust fans are still off (except any doors/windows required to vent the unconditioned space).
10. Connect the Blower Door as displayed in Figure 28 (depressurization) or Figure 29 (pressurization).
11. Connect the red ports together with one red tube, and run the end outdoors as shown in Figure 36. This makes the duct and house pressure measurements use the same reference (outdoors).
12. Set the DucTester to 25 Pa (or -25 Pa) by pressing **[Set Pressure] [25] [Set]** on the DucTester gauge.
13. Repeat step 5 on the Blower Door gauge.

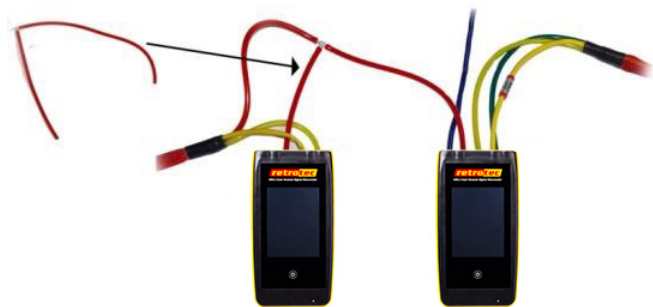

Figure 27: Connecting the red tubes of 2 gauges together with a T-connector

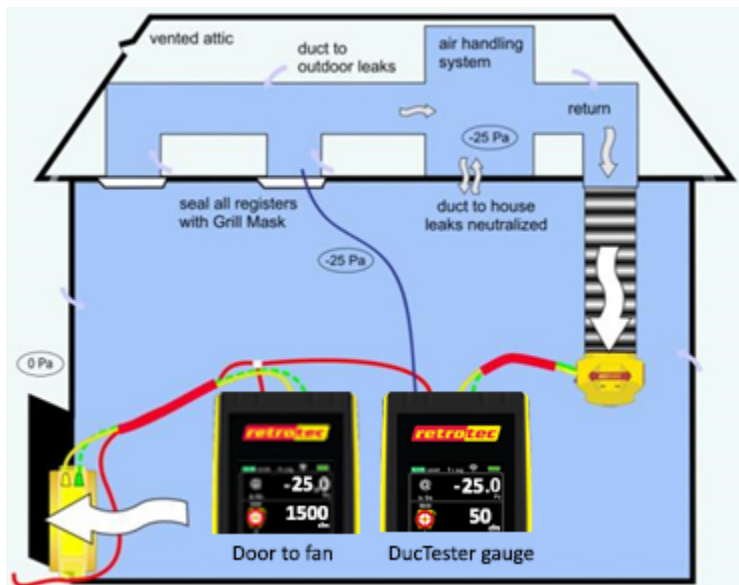

Figure 28: Method #1 Duct Leakage to Outdoors, under depressurization

14. If the Blower Door pressure reading fluctuates more than 2 Pa, press **[Time Avg]** and increase the time averaging to reduce it. If still above 2 Pa, use the Baseline feature as outlined in the *DM-2 QuickGuide* or *DM-2 Operations Manual*.
15. Press **[@]** on the DucTester gauge to display the duct leakage result "@25Pa".
16. Record "Flow" on the DucTester gauge which represents Duct Leakage to Outdoors

If your test requires 50 Pa, substitute 50 for 25 in all instructions.

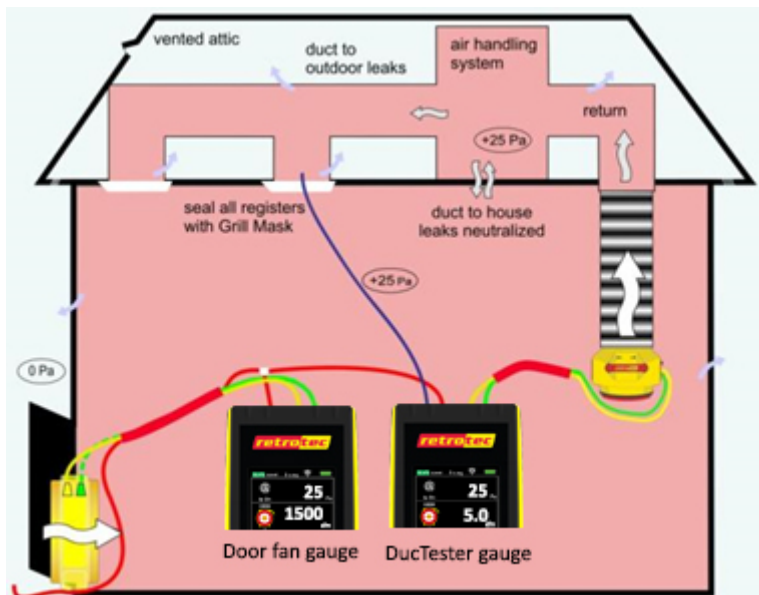

Figure 29: Method #1 Duct Leakage to Outdoors, under pressurization

8.2.2. Method #2: Set duct to house pressure to 0 Pa (using DucTester gauge)

Method 2 does not require connecting a red tube from the DucTester gauge to outdoors, but will result in huge errors if **[@]** is turned on. If your standard requires 50 Pa, substitute 50 for 25 in all instructions.

17. Complete the previous Total Duct Leakage test.
18. Ensure all doors and windows are still closed and exhaust fans are still off.

19. Connect the Blower Door per diagram in Figure 30 (depressurization) or Figure 31 (pressurization).
20. With DucTester fan off, set the Blower Door to 25 Pa by pressing [**Set Pressure**] [**25**] [**Enter**] on the Blower Door gauge.

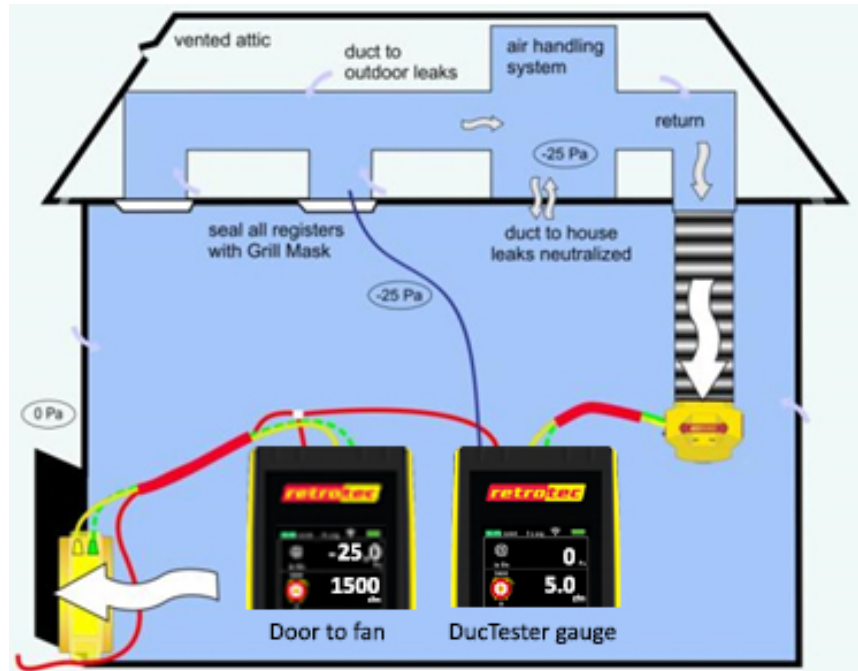

Figure 30: Method #2: Duct Leakage to Outdoors, under depressurization

21. Press [**@**] if required to remove extrapolation; “@ is Off” should then be displayed on the DucTester gauge.
22. Set the DucTester to 0 Pa by pressing [**Set Pressure**] [**0**] [**Set**] on DucTester gauge.
23. When 0 Pa +/- 1 is achieved on the DucTester gauge, record “Flow” from the DucTester gauge, which is Duct Leakage to Outdoors.

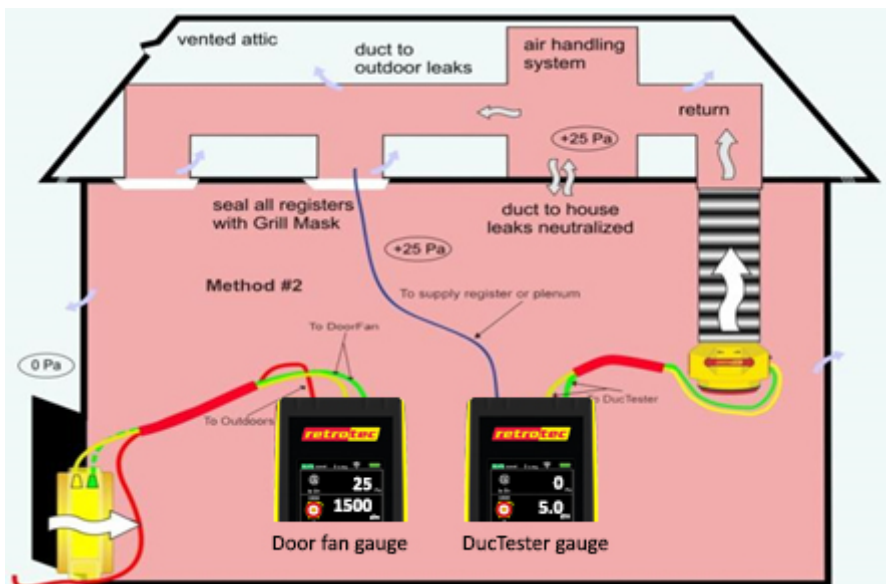

Figure 31: Method #2 Duct Leakage to Outdoors, under pressurization

8.3 Duct Leakage to Outdoors with 1 gauge and 2 fans

Duct Leakage to Outdoors may be measured using only one gauge to alternatively measure the house to outdoor pressure then the duct to outdoor pressure, until the house and ducts are at the same pressure with respect to the outdoors. The method requires connecting and disconnecting the blue tube, alternately measuring the house and duct pressure and adjusting the fans separately until the house and ducts are at the same pressure.

When the house and ducts are at the same pressure, “Flow” on the DucTester gauge displays the result for Duct Leakage to Outdoors.

For depressurization, set the Blower Door to pull air out of the building and the DucTester to pull air out of the duct system. If your standard requires 50 Pa, substitute 50 for 25.

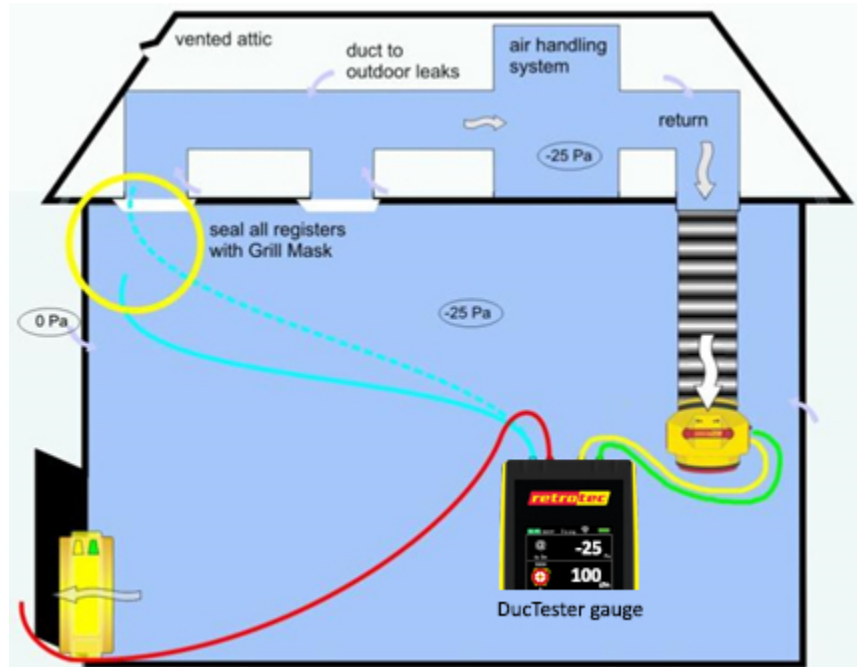

Figure 32: 1 Gauge Duct Leakage to Outdoors under depressurization, setting the building pressure

24. Ensure that the Device is “340” and the correct DucTester Range is selected on the gauge.
25. Close all doors and windows and shut off any exhaust fans in the building.
26. Connect the blue tube from the duct register to the gauge, run the red tube from the gauge to the outdoors, and run the yellow and green tubes to the DucTester.
27. Manually adjust the DucTester speed (with the Speed Control Knob on the DucTester) to reach -25 Pa in the ducts. Wait 60 seconds.
28. With the DucTester still running, disconnect the blue tube from the gauge so the blue port on the gauge is open to the house.
29. Manually adjust the Blower Door speed (with the Speed Control Knob on the Blower Door fan) to change the building pressure until -25 Pa appears for Duct Pressure (Channel A) of the gauge.
30. With the Blower Door still running, connect the blue tube to the gauge and re-adjust the DucTester speed to again set the duct pressure to -25 Pa.



Figure 33: 1 Gauge Duct Leakage to Outdoors under depressurization, setting the duct pressure

- Record duct leakage, "Flow" on the gauge, when you're confident the building and duct pressures have both been stabilized at -25Pa.

For pressurization, set the Blower Door to blow into the building and the DucTester to blow into the duct system. If your standard requires 50 Pa, substitute 50 for 25.

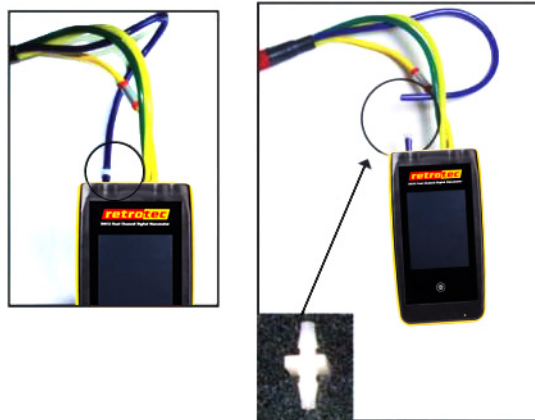

Figure 34: Disconnecting and re-connecting the blue pressure tube is easier using a male-to-male connector

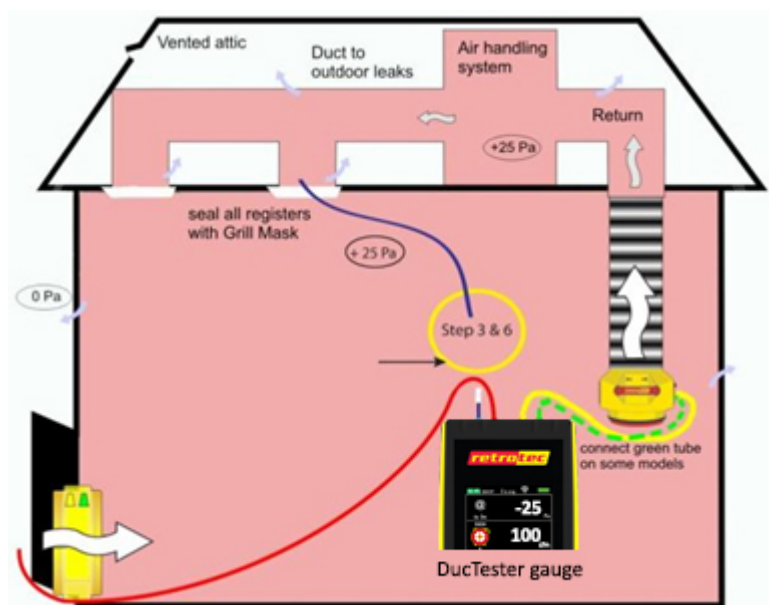

Figure 35: 1 Gauge Duct Leakage to Outdoors under pressurization, setting the building pressure

- Ensure that the Device is 340 and the correct DucTester Range is selected on the gauge.

33. Close all doors and windows and shut off any exhaust fans in the building.
34. Keep the blue port on the gauge open to the house, run the red tube from the gauge to the outdoors, and run the yellow and green tubes to the DucTester. Manually adjust the Blower Door speed (with the Speed Control Knob on the Blower Door fan) to change the building pressure until 25 Pa appears for Duct Pressure (Channel A) of the gauge.
35. Connect the blue tube from the duct register to the gauge.
36. Manually adjust the DucTester speed (with the Speed Control Knob on the DucTester) to reach 25 Pa in the ducts. Wait 60 seconds.
37. With the DucTester still running, disconnect the blue tube from the gauge and re-adjust the Blower Door speed to again set the building pressure to 25 Pa.
38. Connect the blue tube to the gauge and re-adjust the DucTester fan speed to achieve 25 Pa.
39. Record duct leakage, "Flow" on the gauge, when you're confident the building and duct pressures have both been stabilized at 25Pa.

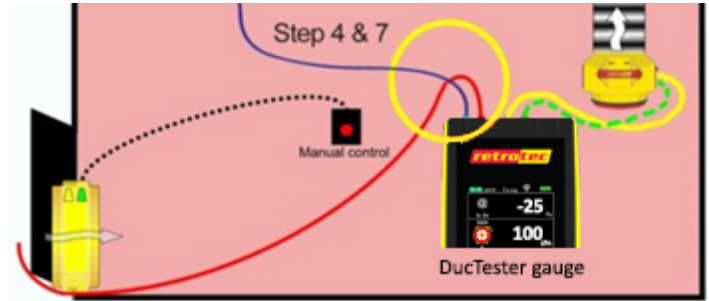

Figure 36: 1 Gauge Duct Leakage to Outdoors under pressurization, setting the duct pressure

8.4 Combined Total Duct Leakage and Duct Leakage to Outdoors Method

This combined method measures both Total Duct Leakage and Duct Leakage to the Outdoors with 2 fans and 2 gauges by setting the duct to house pressure to 0 Pa using the Blower Door gauge. This method is good for repeat testing because both measurements can be made with no changes to the gauge or the tubing between tests. Another advantage is that the @ Pressure function can still be used. Because you pressurize the house first, there will not be the usual problem with blowing seals off registers when the ducts are pressurized. If your standard requires 50 Pa, substitute 50 for 25.

1. Close all exterior doors and windows and shut off exhaust fans.
2. Connect the Blower Door and DucTester as shown in Figure 37.
3. To measure Total Duct Leakage
4. Press **[Set Pressure] [25] [Set]** on the DucTester gauge.
5. Press **[@]** to display the duct leakage result "@25Pa" on the DucTester gauge.
6. To measure Duct Leakage to Outdoors,
7. Turn off "@25Pa" on the Blower Door gauge by pressing **[@]**.
8. Set the Blower Door gauge to 0 Pa by pressing **[Set Pressure] [0] [Set]** on the Blower Door gauge.
9. When 0 Pa +/- 1 is achieved on the Blower Door gauge, record the result from "Flow" on the DucTester gauge which is Duct Leakage to Outdoors.

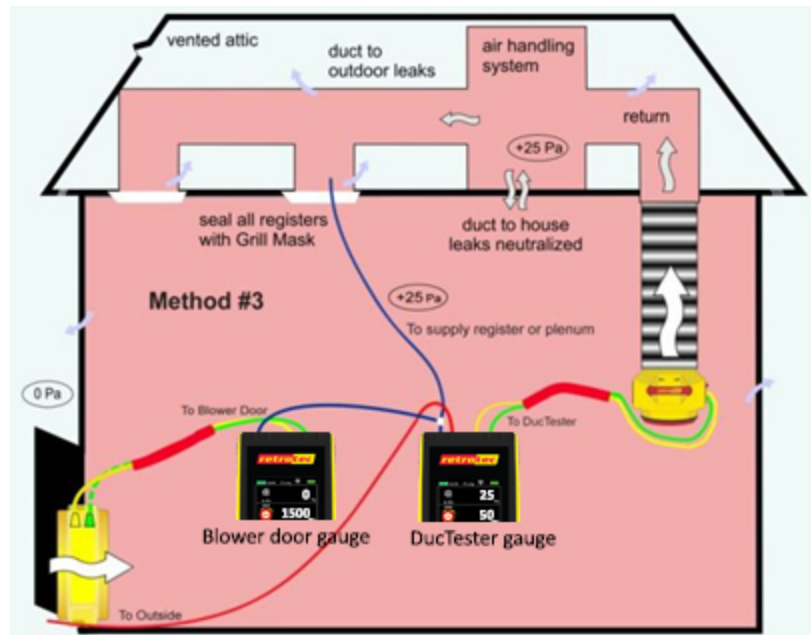
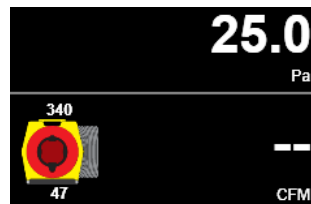

Figure 37: Combined Total Duct Leakage and Duct Leakage to Outdoors Method, under pressurization

8.5 If no Results are displayed (--)



If the target pressure has been reached, but "--" appears as a flow reading, the fan is running too slowly to measure flow. Perform the following to get a duct leakage result:

1. Add the next smaller Range Ring.
2. Change Range Configuration on the gauge to match the Range Ring installed on the fan.
3. Re-adjust DucTester fan speed.

If the Range Ring installed is the smallest hole, there are no more Range Rings to install, and "--" still appears:

1. Make sure Range Configuration on the gauge actually matches the installed Range Ring.
2. Check that the blue tube is connected to the gauge and then check that it is reading pressure – put a finger on the open end of the blue tube and ensure that the Channel A pressure reading changes. If it does not, then the tube is blocked or pinched.
3. Check that there is no blockage in the ducts between the DucTester and the register containing the blue tube. To do this, move the blue tube to a different register and compare the reading on Channel A to the original reading. If the pressures in the two locations are not similar, there may be blockage in the duct system that needs to be removed.
4. Check that the DucTester is actually reading properly on Channel B. To do this, open up a taped register to provide enough leakage to get a reading, and then increase the pressure to 25 Pa or 50 Pa on Channel A. If the flow still reads "--" then the yellow or green tubes could be blocked or disconnected.

If you are sure that the blue tube is reading pressure, there is no blockage in the ducts or tubes, and that the DucTester is actually reading flow, and “--” still appears, the ducts must be extremely tight; less than 7 CFM. To get a rough result, cover half the inlet ring with tape which will quadruple the fan pressure signal. Read the CFM, but divide the answer by two (since half the hole is open). If still reading “--”, cover three quarters of the inlet with tape, read the CFM and divide the answer by four (since only one quarter of the hole is open).

Instead of doing the calculations, an alternative is to set the Result to be Displayed” to “Pressure: Pa” and look up the associated flow in Table 9 (for 25 Pa induced duct pressure).

8.6 Cannot achieve test pressure

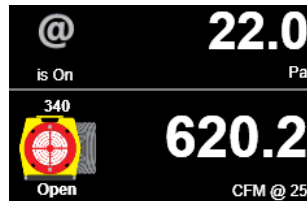

If the DucTester fan reaches 100% speed on the “Range 74” Range Ring before reaching the target pressure, the fan is not providing enough air flow to reach the target pressure. Perform the following to reach the target pressure:

1. Remove a Range Ring.
2. Change Range Configuration setting on the gauge to match the fan.
3. Re-adjust DucTester fan speed.

If there is no Range Ring installed (i.e., “Open” with no more Range Rings to remove), and the desired test pressure cannot be reached at maximum speed:

4. If the duct pressure is close to the required test pressure (within 5 Pa), use the [@] key to extrapolate to what the flow would be at the desired pressure.
5. Try the Duct Leakage to Outdoors test, which will neutralize duct leakage to the house.
6. Look for large disconnects in the duct system by pressurizing the house with the Blower Door and putting smoke in front of the registers. Registers with high velocity smoke movement are a good indication of a potential disconnect behind that register. Fixing the disconnect in the ducts may reduce the leakage enough to continue testing the duct system.

9. Restore the house to pre-test conditions after testing is complete

Notice the conditions in the building upon arrival and be sure to restore it to that condition before leaving.

Before leaving the house

1. Remove all Grill Mask from registers.
2. Replace all filters from the return(s) and air handler.
3. Turn the furnace, air conditioning, HVAC system back on.
4. Ensure any combustible appliances that were turned off are turned back on, and that they are properly vented again.
5. Unseal any closed ventilation, or reconnect the ducts if it was disconnected.
6. Close any exterior doors or windows that were opened during total duct leakage test.

10. Create a Duct Leakage Test Report with Potential Energy Savings

The Retrotec *Duct Leakage Test Reporting software* was developed so users have a way to automatically create professional reports that display duct leakage results as well as potential energy savings. Reports serve as simple documentation of the results of your test and can be used to compare the results of a tested duct system with regulated code or voluntary energy efficiency program requirements (see section 2). These reports can be printed directly or saved and stored as a PDF file.

The latest version of the software can be downloaded from Retrotec's website. Microsoft Excel 2007 or higher must be installed on the computer to run the software. Click on one of the following links to download:

[For Excel 2007](#)

[For Excel 2010 or higher](#)

The screenshot shows the Retrotec Duct Leakage Test Reporting software interface. On the left, there are input fields for Client, Tester, Equipment, Test data, and Cost of Duct Leakage. On the right, a generated report is displayed with the following sections:

retrotec Test Date: 2012-05-29

Duct Leakage Test Report

Client
 Building Description: John Smith's House
 Building Address: 12345 Broadway Street
 Everson, WA 98427
 Contact: Deborah Smith
 Phone: (360) 123-4567

Tester
 Company: Duct Testing Company
 Address: 12345 Main Street
 Everson, WA 98427
 Technician: Colin Genge
 Phone: (360) 738-9835

Equipment
 Test Equipment: Retrotec DU200
 Gauge Serial Number: 203460
 Fan Serial Number: FN1002509

Test data
 Conditioned Floor Area: 300.0 sq ft
 Air Handler Flow: 1250 CFM
 Leakage Exponent: 0.60
 Baseline Pressure: 0.3 Pa

Cost of Duct Leakage
 % of Duct Leakage to Outdoors: 80%
 Annual Cooling Cost: \$1,100
 Annual Heating Cost: \$1,500

Building and Duct Details
 Conditioned Floor Area: 300.0 sq ft
 Air Handler Flow: 1250 CFM
 Percentage of Duct Leakage to Outdoors: 75% (estimated)

	Supply	Return
Average Duct Operating Pressure	25.0 Pa	25.0 Pa
Leakage Split	50%	50%
Leakage Penalty	100%	50%

Leakage Data
 Baseline Pressure: 0.3 Pa

Depressurization
 Duct Test Pressure: -25.5 Pa
 Fan Test Pressure: 597.0 Pa
 Range Configuration: Mid
 Duct Leakage: 188 CFM
 Leakage Area: 34.7 sq in
 Leakage constant, C: 26.99
 Leakage Exponent: 0.60 (assumed)

Leakage Results
 Total Duct Leakage: 188 CFM at 25 Pa
 Duct Leakage as % of Air Handler Flow: 15.1%
 Duct Leakage to Outdoors (estimated): 141 CFM at 25 Pa
 Leakage/Conditioned Floor Area: 0.628 CFM/sq ft at 25 Pa
 62.8 CFM/100 sq ft at 25 Pa
 628 CFM/1,000 sq ft at 25 Pa

Duct System Losses
 HVAC System Efficiency Loss: 8.5%
 Annual Cooling Loss: \$93
 Annual Heating Loss: \$127

10.1 Get the Excel spreadsheet based software to run on your system

10.1.1. Enable Macros (with Office 2007)

For the software to run properly, macros must be enabled. To enable macros:

Click the "Options..." button (by the Security Warning, on the toolbar shown below)

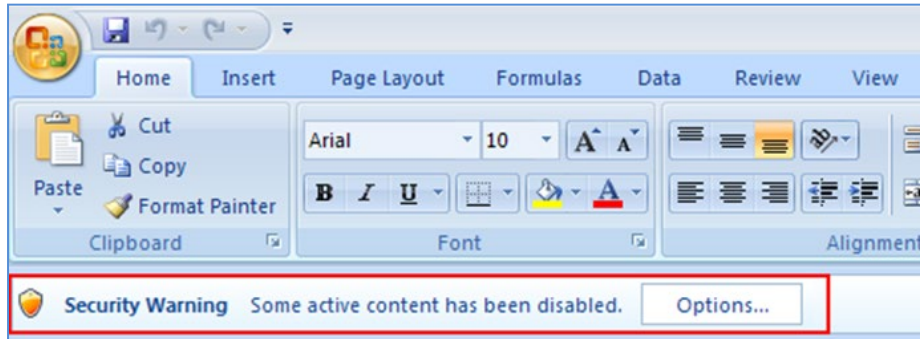

Select "Enable this content"

Click "OK"

Occasionally, you may get this popup prompt when you open Excel:



In this case, click "Enable Macros" and you will not have to perform the procedure above.

10.1.2. Enable Macros (with Office 2010)

For the software to run properly, macros must be enabled. Before Office 2010 allows you to enable macros, depending on which version of the Duct Leakage Test Report software you have, there may be a warning you have to bypass, before enabling macros. You may see the following "Protected View" warning (red bar):

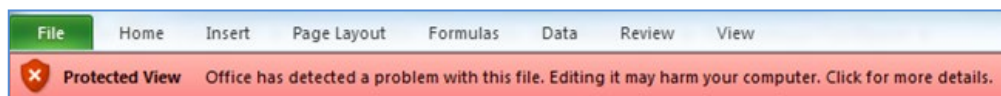

If so, click on it, and you will see the following Protected View option:



Click “Edit Anyway.” Now go back to the main screen and you will see the option to enable macros:



Click the “Enable Content” button.

10.1.3. Showing/Hiding the Ribbon

When Macros are enabled, the software automatically hides the MS Excel “Ribbon” since it is not used.

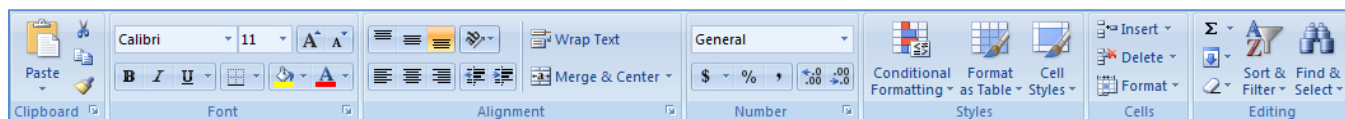

Figure 38: The MS Excel “Ribbon”

After closing the software however, the Ribbon remains hidden when a new Excel spreadsheet is opened. If it’s desired to have the Ribbon shown again, press Ctrl + F1 at any time. Pressing Ctrl + F1 again will hide the Ribbon.

10.1.4. Enter test information and results into green cells

Only enter test data or details into the green cells.

To reset all inputs, click the “Reset all Inputs” button at any time:

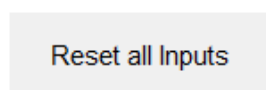

10.2 Choose metric or imperial units for results

Use the dropdown menu to select the desired units for data entry and results.

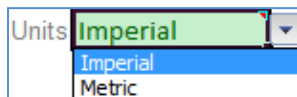

10.2.1. Imperial units

“Flow” and “Duct Leakage”: cubic feet per minute, or CFM

“Conditioned Flow Area”: square feet, or sq ft

“Leakage Area”: square inches, or sq in

10.2.2. Metric units

“Flow” and “Duct Leakage”: cubic metres per hour, or m³/h

“Conditioned Flow Area”: square meters, or m²

“Leakage Area”: square centimeters, or cm²

10.3 Choose Duct Test type

Click to select the type of test you are performing: a Total Duct Leakage test or a Duct Leakage to Outdoors test.

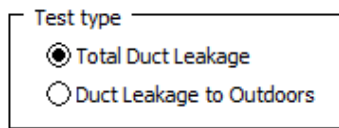

Test type

Total Duct Leakage

Duct Leakage to Outdoors

The differences between a Total Duct Leakage test and a Duct Leakage to Outdoors test are described in section **Error! Reference source not found.**. For the setup of these tests, refer to the illustrations and descriptions in section 8.

10.4 Enter the Target test pressure

Use the dropdown menu to select the pressure at which the duct system was tested, and the pressure at which the results will be displayed.

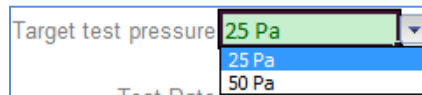

Target test pressure 25 Pa

25 Pa

50 Pa

Codes or programs usually require this pressure to be 25 Pa, however it may be 50 Pa. See section 2 for these requirements.

Leakage Results	
Total Duct Leakage	188 CFM at 25 Pa
Duct Leakage as % of Air Handler Flow	15.1%
Duct Leakage to Outdoors (estimated)	113 CFM at 25 Pa
Leakage/Conditioned Floor Area	0.628 CFM/sq ft at 25 Pa
	62.8 CFM/100 sq ft at 25 Pa
	628 CFM/1,000 sq ft at 25 Pa

10.5 Enter date the test was carried out

Enter the test date in the format of YYYY-MM-DD, where YYYY is the year displayed in four digits, MM is the month displayed in two digits, and DD is the day displayed in two digits.

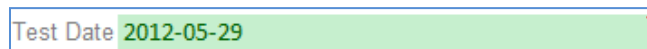

Test Date 2012-05-29

10.6 Enter specific parameters for the conditions of this test

10.6.1. Conditioned Floor Area

The Conditioned Floor Area is the area that is normally air-conditioned or heated (i.e., inside the building envelope). Even though supply ducts may not discharge directly into all these spaces, they are considered “conditioned” if their temperature follows indoor temperature closer than outdoor temperature. Likewise, if the area is not air-conditioned or heated, it is not considered to be part of the Conditioned Floor Area.

The area entered is used to calculate the result for “Flow/Area” that will be displayed on the report. The Duct Leakage Test Report calls this result the “Leakage/Conditioned Floor Area”.

10.6.2. Air Handler Flow

This is the total air flow through the duct system provided by the system air handler.

Air Handler Flow 1250 CFM

This input is optional, and is only needed if you want the report to display the “Duct Leakage as a % of Air Handler Flow”.

Duct Leakage as % of Air Handler Flow 8.6%

If this value cannot be found under the Air Handler’s design specifications, it can be measured using methods described in section 12. It can also be calculated using the forms in Appendix F.

systems.

10.6.3. Baseline pressure

The Baseline pressure is the pressure between the enclosure and the outdoors due to stack, wind, and flues (with the DucTester fan turned off). Baseline pressure is also called “static pressure”, “bias pressure,” or “zero Fan Pressure difference”. These terms are used interchangeably with each other in documents/standards used in the industry.

It is optional to enter a Baseline pressure, since its values are usually very insignificant for duct leakage test results. This is because not a huge portion of the ducts (as opposed to buildings) are directly connected to the outdoors.

A method for determining Baseline pressure is by having a digital gauge accumulate readings over an adjustable time period. The [**Baseline**] function on the gauge (from [**Settings**] menu allows for this measurement to be taken. For more information, refer to Retrotec’s *DM32 Operation* manual.

10.6.4. Enter whether pressurizing or depressurizing (Test direction)

Click to select whether the DucTester fan is setup to depressurize or pressurize the duct system (see section 6.9).

Test direction

Depressurization

Pressurization

10.7 Enter readings from this test

10.7.1. Duct Pressure

Enter the Duct Pressure during the test, which is the Channel A reading on the DucTester gauge. The Duct Pressure in the software are always assumed to be the pressure of the ducts relative to the pressure of the outdoors.

The Duct Pressure should be a positive number for pressurization, and negative number, with a “-“ sign, for depressurization. This is important if you have entered a Baseline pressure since the calculated Duct Test Pressure will then be different depending on the sign.

There are two important points to remember for recording Duct Pressures:

If the [**Baseline**] function on the gauge was used, you must ensure the Baseline was cleared before starting the fan. If this is done properly, the Baseline reading on the DM32 gauge (under the Result) will not show.

Clearing the Baseline value on the gauge ensures that the Channel A pressure on the gauge does not subtract the Baseline pressure, since the software will subtract this once it is entered. In order to avoid subtracting Baseline pressure twice – once on the gauge, and again in software, ensure the gauge is not using a Baseline value.

If you are using the Method 2 or Combined Method to do the Duct Testing, described in section 8.2.2 and 8.4 respectively, where you are setting the pressure between the duct system and the house to 0 Pa, enter 25 or -25 Pa (Duct Pressure relative to outdoors), NOT 0 Pa.

10.7.2. “Enter Flow directly” selection or Range Configuration selection

The dropdown menu is used to select whether you want to enter data as:

“(Enter Flow directly)” from the gauge, or a **Range Configuration** selection

It does not matter which of the two methods you choose, since either one will calculate the same results. If you select “(Enter Flow directly)”, Flow result from gauge needs to be entered. Alternatively, if you select a Range Configuration, Fan Pressure result from the gauge needs to be entered.

The following screenshots shown below in each section are: the dropdown selection, the inputs that will appear as a result of that selection, and the Leakage Data that appears on the generated report as a result of that selection. The inputs highlighted in red are what would be copied from the gauge.

“(Enter Flow directly)” selection:

The screenshot displays two dropdown menus. The first, labeled 'Pressurization', has a value of '-25.0 Pa' and a dropdown arrow pointing to '(Enter Flow directly)'. The second, labeled 'Depressurization', has a value of '-25.0 Pa' and a dropdown arrow pointing to '(Enter Flow directly)'. Below these, a table shows the following data:

Depressurization	
Duct Pressure	-25.0 Pa
Duct Leakage	103.0 CFM

Range Configuration selection:

Depressurization	
Duct Pressure	-25.0 Pa
Range Configuration, or Enter "Flow" directly	74
Fan Pressure	74
Flow (calculated)	212.0 Pa
	103.0 CFM

To clear the test data shown in this section, click the “Clear Test Data” button.

Clear Test Data

10.7.3. Convert “Flow/Area” data so it can be entered into spreadsheet

Before obtaining the Duct Leakage Test Reporting software, you may have previously only recorded the “Flow/Area” data directly from your gauge, but no “Flow” data. Now you might like to print a report based on this Flow/Area. You will soon realize that you cannot enter Flow/Area data directly into the software to obtain results. Instead, you must enter “Flow” to calculate results; therefore, you must calculate a “Flow” to enter.

Example:

You live in North Carolina, and your state code requires that you report your results in the units of CFM/100 sq ft. During a prior test of your client’s duct system, you measured and recorded a Flow/Area of 26.3 CFM/100 sq ft at 25.0 Pa on your gauge. The conditioned flow area of the house is 1500 sq ft. What do you enter into the software as your “Flow”?

$$\text{Flow} = \frac{\text{Flow}}{\text{Area}} * \text{conditioned floor area}$$

$$\text{Flow} = \frac{26.3 \text{ CFM}}{100 \text{ sq ft}} * 1500 \text{ sq ft}$$

$$\text{Flow} = 395 \text{ CFM}$$

You would enter a “Flow” of 395 CFM, at a “Duct Pressure” of 25 Pa, with a “Conditioned Floor Area” of 1500 sq ft into the software.

10.8 Spreadsheet will calculate Cost of Duct Leakage

Values for parameters can be entered into the “Cost of Duct Leakage” section so that estimates of the Annual Cooling Loss and Annual Heating Loss (i.e., potential energy losses due to duct leakage) can be reported. These inputs are optional. If nothing is entered into this section, the “Cost of Duct Leakage” section of the report will not appear in the output.

Cost of Duct Leakage

HVAC System Efficiency Loss **12.3%**
Annual Cooling Loss **\$136**
Annual Heating Loss **\$185**

For further detail on Duct system loss parameter calculations, refer to section 13.

If you are unsure of what the values are, simply assume the default values by clicking the "Use Default Values" button:

Use Default Values

Note: The "Annual Cooling Loss" and "Annual Heating Loss" in the Duct Leakage Report are for estimation purposes only.

10.8.1. % of Duct Leakage to Outdoors

Enter the estimated percentage of the Total Duct leakage that leads to outdoors in order to estimate Cost of Duct Leakage. (Input is only required when performing a Total Duct Leakage test)

10.8.2. Annual Cooling Cost

Enter the cooling cost per year from the utility bill. This entry is used to estimate the cost of Duct Leakage to Outdoors that is included in the cooling bill.

10.8.3. Annual Heating Cost

Enter heating cost per year from the utility bill. This entry is used to estimate the cost of Duct Leakage to Outdoors included in the heating bill.

10.8.4. Average Duct Operating Pressure

Measure the pressure in the supply duct closest to the plenum and enter that pressure to get an accurate calculation of duct losses. Do the same for the return. Using the test pressure (default value) here will not be accurate.

10.8.5. Leakage Split

Enter the estimated fraction of the Total Duct Leakage that is on the supply side and the return side. The default values are 0.5, meaning the leakage of the HVAC system is split evenly between the supply and return. Adding the Leakage Split for the supply side and the return side together should always come out to 1.0.

10.8.6. Supply Leakage Penalty

This is the estimated fraction of energy loss of the supply side. The default value is 1.0. This means that of the supply air leakage, all of its energy is lost to the outdoors (i.e., none of its energy is returned back into the house). This number can be lowered if some of the energy from duct leakage leads back into the house. For example, if supply leaks are going into a wall cavity, some of the energy will be go back into the house, so a lower leakage penalty would provide a better estimate of annual HVAC losses.

10.8.7. Return Leakage Penalty

This is the estimated fraction of energy loss of the return side. The default value is 0.5, which assumes that of the return air leakage, about half of its energy is lost to outdoors (i.e., the other half of its energy stays inside the house). This number can be raised if you suspect that there is actually more energy loss to the outdoors from the return side. For example, if the return goes through a very cold crawl space, the return leakage would pull in cold air and have a greater effect on the annual HVAC losses.

10.9 Save the Duct Leakage Test Report as a PDF file

10.9.1. With Office 2007:



Click the MS Office icon at the top left corner of the window:

Mouseover "Save As" on the menu → Click "PDF or XPS"

Select the directory to save the PDF file to → Enter a proper file name for the PDF file to as

Click "Publish"

10.9.2. With Office 2010

Click "File" → "Save As" → Change the "Save as type" to "PDF "

Select the directory to save the PDF file to → Enter a proper file name for the PDF file to as Click "Save"

11. Find air leaks in the ducts

Locating leaks in the ducts can be a tricky process, and there are a number of methods that are used.

11.1 Using a smoke puffer

Smoke puffers work similarly to theatrical smoke for finding leaks, but on a much smaller scale. The chemical smoke of Retrotec's Air Current Tester is the same density as air, and therefore does not move unless there is air movement. Puff out a small amount of smoke near suspected leaks, (for example, near joints, or in front of registers), while the DucTester is connected to the ducts and running, and notice the smoke either being blown away or being sucked in, depending on the direction of the test.

11.2 Using theatrical smoke

The use of theatrical smoke can be a very effective way to find leaks in a duct system. A theatrical smoke machine is used to inject non-toxic chemical smoke into the duct system. Walking around to check the duct systems will point out obvious leak locations where smoke appears. This can help find hard-to-detect leaks in attics and crawlspaces. Using this type of detection is called theatrical for a reason – it is quite a sight to see for homeowners and builders.

Caution: Make sure not to inject the smoke directly into the fan motor, but instead inject it into the flex duct just after the fan. Injecting the smoke directly into the fan motor will void the warranty of your DucTester. Use of the quick connect collar aids in this operation. Also, make sure to clean any residue away from the flow sensors, motor and fan housing when the show is over. The particles can block the sensors needed for measurements.

11.3 Using an infrared camera

An infrared camera can graphically display areas where cold air is infiltrating into a house or building, or show from the outside, where hot air is exfiltrating. The camera can also show zones that are poorly insulated, and would otherwise be invisible without opening up wall sections.

11.4 Using a wet hand

Sometimes, a damp hand is more than enough to feel the movement of air around a leak. Wet skin will feel cool or cold in the path of moving air.

11.5 Using a Pressure Pan

If a Blower Door system is available, checking all the registers with a Pressure Pan, prior to doing a duct leakage test, can be useful for finding the leakiest part of the system, and for determining the most conservative location for the DucTester system pressure pickup. A pressure pan test can also locate large disconnects in the duct system, which may prevent the acquisition of a useful result in a full duct leakage test. Set the Building Pressure to 25 Pa, and cover the register with the Pressure Pan connected to the blue port of the DM-2; readings over 1 Pa indicate some leakage, readings over 5 Pa is severe leakage at that register and 25 Pa indicates a complete disconnect.



Figure 39: Pressure Pans, large and small shown

Table 5: Retrotec Pressure Pans

Pressure Pan	Dimensions (in)	Part number
Large	24.5 x 24.5 x 8.75	PP101
Small	13 x 15 x 4.5	PP102

For more information about conducting a Pressure Pan test, see the Retrotec *Residential Pressure & Air Leakage Testing Manual*.

12. Measure the Air Handler system flow

12.1 For Code compliance

For Code compliance testing, the air handler flow rate is seldom measured because it takes too much time. Typically air handler flow is calculated by using 400 CFM per Ton or 21.7 CFM per 1000 BTU. Other Codes require results expressed as CFM of duct leakage per square foot of conditioned floor area.

Small (around 2 Ton) systems with a single return can have their air flow measured at the return. Measuring from the air handler cabinet is preferred, especially for systems greater than 2 Tons.

12.2 Why measure the Air Handler system flow?

Air handler system flow rates are required to evaluate system performance. Reduced flow rate is one of the prime reasons that HVAC systems underperform. For air conditioners, insufficient flow leads to excessively cold coils that will ice up and reduce performance in that way. For heating systems, insufficient airflow will cause too great a temperature rise that will cause an over-temperature condition that will cause the furnace to short cycle, reducing its efficiency.

In both cases, insufficient air flow will affect comfort and decrease the system's ability to maintain the desired room temperature. This may cause homeowners to mistakenly assume that their system is too small and replace their unit with a larger one that will make matters even worse.

Variable speed systems are less prone to short cycling due to insufficient airflow unless the load becomes great enough to cause the unit to operate near its upper limit of capacity at which point it will short cycle.

12.3 Measure with a DucTester as a powered flow hood on the return

The Retrotec DucTester and Flow Hood can be used to measure air flows through supply registers, exhaust fans and other airflow devices, without affecting their flow rate, by neutralizing the pressure that would create a resistance to flow. By using the DucTester to create a Powered Flow Hood, a vent area can be "set to zero", eliminating any pressure difference. This is unlike using a traditional flow hood, where the flow hood itself creates a resistance to flow, altering what is being measured.

The Flow Hood looks similar to the Retrotec Pressure Pan, except it has a ten inch diameter hole in the center and an array of pressure pickup tubes inside. The hole makes the Flow Hood ready to attach the Flex Duct. Pass the Flange through the 10 inch hole in the Flow Hood and attach the Flex Duct.

For measuring supply flows, attach the Flex Duct to the inlet (suction) side of the fan over top of the Range Rings. For measuring return flows; attach the Flex Duct to the outlet (discharge) side of the fan.

Attach the blue Tube to the connector on the Flow Hood. Connect the other end to the "Input A" port (blue) on the gauge. The "Ref A" (red) port on the gauge should be left open.

Connect the green and yellow tubing to the "Input B" (green) and "Ref B" (yellow) ports on the gauge respectively. Connect the other ends to the same color ports on the DucTester.



Figure 40: Measuring air flow with a Powered Flow Hood

Adjust the **[Set Speed]** until Channel A reads a pressure of 0 Pa. Record the flow in CFM. To have the DucTester automatically acquire and maintain a 0 pressure, press **[Set Pressure] [0] [Set]** and the gauge will cause the DucTester to increase in speed to eliminate whatever pressure it sees at the time that the keys are pressed.

Ensure the pressure that is to be set to 0 actually exists before the keys are pressed because it uses the direction of the pressure to set the direction of control. This means that the fan speed up to eliminate the pressure it first sees regardless of sign. Make sure the “@ Pressure” feature is turned off, otherwise erroneous results will occur due to the result being divided by whatever tiny pressure occurs above or below zero.

12.4 Measure air handler flow using a blower door



A blower door can be the ideal tool to measure air handler flow because it has more flow capacity than any residential airhandler. A Duct Tester can also be used but will not measure the largest residential air handler flows. In California for example, 350 CFM is required per Ton; so a 5 Ton system would need 1750 CFM of airhandler flow. Above the capacity of most duct testers.

Using this measurement method may be the lowest cost alternative since either a Blower Door and/or Duct Tester may already be on site when the system airflow must be measured, all you must do is to connect them to the duct work with the flexduct.

Figure 41 Flex attached to Blower Door

Both methods will typically have errors of less than 7% or 5 CFM whichever is greater.

Since flow will be measured in real time, airhandler flow rate can be displayed on a Smart Device while adjustments are made to the system; such as opening register control dampers, opening and closing interior doors that will all affect total airhandler flow rate.

Both methods duplicate the inlet conditions to those that would be in effect at the register prior to measurement. In the plenum matching method, the flow is going to be the same so the pressure at the register will effectively be zero while in the second method this value is measured directly.

12.4.1. Supply plenum pressure matching method

Run the airhandler with a clean filter in place. Measure the static pressure in the supply plenum with a Blue tube going to Channel A. Insert a static pressure probe in an area where the pressure signal is stable meaning it does not fluctuate more than 3% on 5 second averaging. Record this pressure.

The Flow Device with the flex duct must then be connected to a return or air handler cabinet using a flange or box attached to the flex duct. To ensure the Device measures the exact flow that was there before the Device was connected, the test fan must be run at a speed that will recreate that same flow rate. Set Pressure to the previously measured supply plenum pressure and the Device will adjust its speed automatically to recreate the original plenum pressure and yield an accurate flow measurement through the return register. Use the “@” feature which will extrapolate your readings to the exact pressure previously recorded in the supply plenum.



**Optional
Sierra Building
Science device
for measuring
air handler
flow using a
blower door
connected with
flex to a**

12.4.2. **Set pressure in front of return register to zero method or using your Blower Door as a powered flow hood**

Another possibly more convenient way to eliminate the insertion effect of the Device, would be to measure the pressure at the flange or box that connects the flex to the wall register, then Set Pressure on the gauge to 0 so the fan will speed up until there is no resistance to flow caused by the Device. You can then measure the flow rate caused by the air handler through that register. Since the flow rate into the return will cause turbulence and the presence of the attachment will change the air flow lines into the register, this method may not be as accurate as the previous method.

If there are multiple registers, the flow through each register could be measure separately, then the sum of all register could be used to determine total air handler flow.

Typically, once installed the pressure tap on the flange will yield a negative pressure that will be displayed on Channel A. You would then Set Pressure to zero which would cause the fan to speed up and return the pressure at the flange to zero which closely approximates the condition prior to the flange being installed over the return register.

This method will NOT work when the Device is mounted to the airhandler cabinet since the pre-existing pressure will already be a large negative value and setting this to zero would eliminate all the resistance of the return ductwork and give a much larger flow rate than was actually present under normal operating conditions.

12.5 Measure large exhaust and intake flow rates

The previous methods can be utilized to measure large rooftop exhaust or air intake flow rates. The essential idea behind the test method is to construct a tent over the source of the flow and to use a blower door to bring the pressure inside the measurement tent to zero and in so doing to not affect the flow rate that was there originally. There are two methods to do this:

1. Measure the pressure difference across the tent with at least two pressure hoses T'd together going to the Blue port of the gauge and to connect the red port of the gauge to at least two pressure hoses T'd together going to the Red port of the gauge. This works well in calm weather but when the wind is blowing it will be difficult to determine zero pressure.
2. Measure the pressure difference between inside the duct referenced to indoors. This pressure signal can be WiFi'd to the operator on the roof who can measure the flow rate into or out of the tent required to re-establish the pressure in the duct prior to the installation of the tent.

Construction of the tent is from stock PRV pipe parts. They can be press fit together to create a framework and covered in plastic using Red Tuck Tape to hold 3 mil Poly together. The blower door fan may rest on the ground and be taped to the poly our mounted in a panel that is taped to the poly. Super tight fit is not essential because the tent will be very close to zero pressure during the measurements.

Use the "Set Pressure" function on the gauge to set the pressure to zero for method 1 and to the duct pressure in Method 2. Do NOT use the "@" function for Method 1 but you should use it for Method 2.

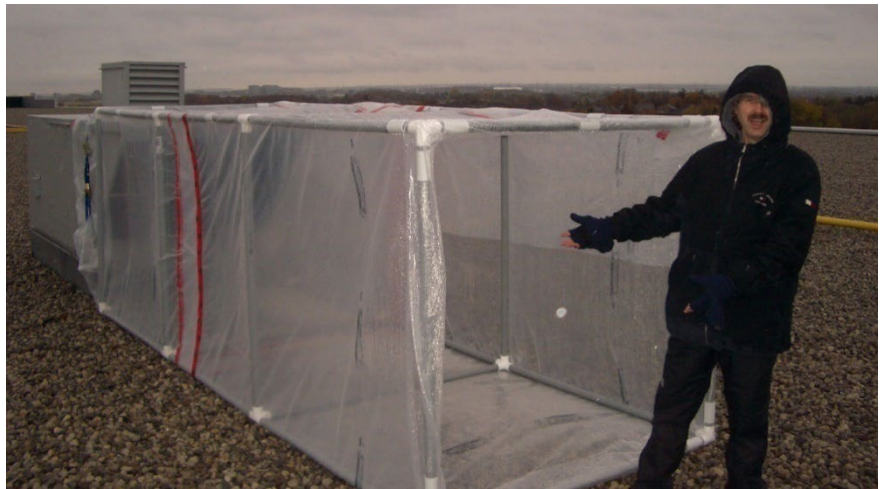

Figure 43 Tent made of poly and PVC pipe courtesy of Terry Brennan of Camroden Associates

Rough guidelines for the minimum size of the tent are?

Tent size on each side	Maximum flow into tent	Maximum flow out of tent
2 feet	750 CFM	1500 CFM
3 feet	1500 CFM	3000 CFM
4 feet	3000 CFM	6000 CFM
6 feet	6000 CFM	12000 CFM

Larger tents generally work better because velocities are lower.

12.6 Measure with a DucTester on the air handler cabinet

Measure the supply plenum pressure using the Static Pressure Probe supplied with each DucTester. Put the end of the blue tube with the probe into the supply plenum, connect the other end of the blue tube to the "Input A" (blue) port and read the pressure from Channel A on the gauge.

Attach the DucTester to the cabinet using cardboard and tape so it is blowing into the air handler on the Open range. Set Pressure to the previously measured value. Press **[Set Pressure]** and enter the previously measured supply plenum pressure. Press the **[@]** key until the supply plenum pressure appears as "CFM@". Read the "CFM@" result on the gauge.

For example, if the pressure in the supply plenum is 70 Pa, Press **[Set Pressure]**, **[70]**, **[Enter]** to get the DucTester to recreate the original pressure in the plenum. Press the **[@]** key until "CFM @ 70 Pa" appears on the display. The CFM result displayed will be corrected for what the airflow will be during normal operation (the supply pressure in the plenum measured at the start of the test).

If "---" appears the pressure in the plenum is too high to get an accurate reading. Repeat the procedure but move the Static Pressure Probe to measure the pressure farther away from the air handler.

12.7 Measure with a gauge and a flow grid

A unique Retrotec feature allows the gauge to be used with flow grids from other manufacturers.

Measure the supply plenum pressure using the Static Pressure Probe supplied with each DucTester. Put the end of the blue tube with the probe into the supply plenum, connect the other end of the blue tube to the "Input A" (blue) port and read the pressure from Channel A on the gauge.

Install the flow grid into the filter slot per manufacturer instructions, which includes connecting the green and yellow tubes to the gauge. Press **[Set Pressure]** and enter the just measured supply plenum pressure, even though the gauge is not controlling anything. Press the **[@]** key until the supply plenum pressure appears as "CFM@". Read the "CFM@" result on the gauge.

For example, if the pressure in the supply plenum is 70 Pa, Press **[Set Pressure]**, **[70]**, **[Set]** to get the DucTester to recreate the original pressure in the plenum. Press the **[@]** key until "CFM @ 70 Pa" appears on the display. The CFM result displayed will be corrected for what the airflow will be during normal operation (the supply pressure in the plenum measured at the start of the test).

If "---" appears on the display as the result, the pressure in the plenum is too high to get an accurate reading. Remove the probe from the plenum, read the CFM on Channel B and use the table that came with the flow grid to correct the flow to match the pressure measured in the supply.

12.8 Measure using air handler blower curves

If air handler blower curves are available, they will show system flow versus pressure across the air handler, from supply to return. To determine the pressure across the air handler, measure the pressure between the air handler cabinet on the return side and the supply plenum.

You may need the results in units other than Pascals, often inches WC, depending on what pressure units are used on the air handler blower curves. Do this by pressing **[Settings] [Result to be Displayed]**

and toggle the **[Pressure]** button until the desired units is displayed, such as inches of Water Column (in WC).

You could manually convert Pascal readings by dividing the pressure in Pascals by 250 for inches Water Column.

12.9 Measure using Hole Flow on the gauge

Because flow through a known size hole depends on pressure across the hole, and air flow into an enclosed space will cause pressure and flow through the hole, we can use a box with a hole in it to measure the system air flow.

Cut the flaps off one side of a medium-sized cardboard box. Cut a 2" x 2" square hole in the center of another side where the cardboard is only one layer thick. Punch a 0.25 inch diameter hole in the box near the opening and insert a tube into this hole. Connect the other end of the tube to the yellow port of the gauge (so Channel B is reading the pressure inside the box instead of from the fan). The gauge should show Pressure on Channel B in Pascals.

Observe the pressure in the box. Increase the size of the hole in the box until the pressure is about 5 Pa. Box pressure of 8 Pa or less are recommended because higher pressures mean the air handler is increasingly blocked and the test method itself is affecting the performance.

On the Retrotec gauge, set the device to "Hole Flow". Enter the area of the hole into the gauge using the **[Area]** key, ensuring that the units you use for area match what the gauge is expecting for area. Units for area when calculating Hole Flow default to square inches. Read the CFM directly from the gauge to get the air handler flow.

Because this method partially blocks the flow from the air handler, readings are not exact, especially if pressures in the box are above 8 Pa.

12.10 Measure with a Blower Door attached to the return or cabinet

Measure the supply plenum pressure using the Static Pressure Probe supplied with each Blower Door. Put the end of the blue tube with the probe into the supply plenum, connect the other end of the blue tube to the "Input A" (blue) port and read the pressure from Channel A on the gauge.

Attach a 24 inch Flex Duct (optional accessory to Retrotec Blower Doors) to the outlet side of the Blower Door fan and the Flex Duct flange to a return or the air handler cabinet so it is blowing into the ducts on the Open Range. Set the pressure to the just measured supply plenum pressure. Press **[Set Pressure]** and enter the previously measured supply plenum pressure. Read the CFM result directly from the gauge after waiting for at least one minute to let the measurement settle down.

For example, if the pressure in the supply plenum is 70 Pa, press **[Set Pressure]**, **[70]**, **[Set]** to get the Blower Door to recreate the original pressure in the plenum. Read the CFM result directly from the gauge

If "---" appears the pressure in the plenum is too high to get an accurate reading. Repeat the procedure but move the Static Pressure Probe to measure the pressure farther away from the air handler.

12.11 Other methods

Temperature rise and other standard HVAC methods exist but are not covered here.

13. Estimate HVAC system energy loss from ducts

13.1 Duct Air Leakage Measurements

In this section, you will learn a simple method for estimating HVAC system losses through field measurements of duct air leakage. Assumptions must be made about the HVAC and duct systems (including system airflow, operating pressure in the ductwork, supply and return breakdown of leakage, and energy loss penalty from supply and return leaks) to estimate the annual energy loss for heating or cooling in the climate in question.

This estimation technique must be used with caution, as duct leakage loss calculations are extremely complex, and many assumptions are being made in order for the estimation to work. The leakage rate determined using the following air leakage procedure may differ from actual operating conditions. This simple model should not be used for research purposes, program design or impact evaluations, as more sophisticated duct leakage loss models are available and more accurate.

To use software to perform the simple methodology below, refer to section 10.

13.2 Methodology

Complete a "Duct leakage to outside" test

Record the leakage rate in CFM at 25 Pa (CFM25).

Determine the CFM25 multiplier for average operating pressure

It has been assumed that 25 Pa is a representative pressure for leaks in the duct system under normal operating conditions. However, if you have evidence to suggest that another pressure would better represent leaks under normal conditions, this can be modified. Use the following table to adjust CFM25 for different average operating pressures.

During normal (average) operating conditions, duct pressures can vary greatly. They are much more stable during a duct leakage test. Use separate multipliers for the return and supply ducts, respectively (as necessary).

Definitions:

Average Operating Pressure: 25 Pa is a representative pressure for leaks in the duct system under normal operating conditions. However, if you have evidence to suggest that another pressure would better represent leaks under normal conditions, this can be modified.

Pressure Multiplier is a factor applied to calculate the Loss Factor, based on the normal Average Operating Pressure.

Table 6: CFM25 multipliers for average operating pressures. Multiplier for CFM25 = (Avg. Operating Pressure/25)^{0.60}

Average Operating Pressure (Pa)	Multiplier for CFM25
5	0.38
10	0.58
15	0.74
20	0.87
25	1.00
30	1.12
35	1.22
40	1.33
45	1.42
50	1.52

Average Operating Pressure (Pa)	Multiplier for CFM25
55	1.60
60	1.69
65	1.77
70	1.85
75	1.93
80	2.01
85	2.08
90	2.16
95	2.23
100	2.30
105	2.37
110	2.43
115	2.50
120	2.56
125	2.63
130	2.69
135	2.75
140	2.81
145	2.87
150	2.93
155	2.99
160	3.05
165	3.10
170	3.16
175	3.21
180	3.27
185	3.32
190	3.38
195	3.43
200	3.48

When possible, use actual operating conditions to determine the best multiplier to use from the table above.

Calculate a loss factor for supply and return leaks

Supply Loss Factor = (SLS x SLP x SPM)

Where: SLS is Supply Leakage Split (default 0.5)

SLP is Supply Leakage Penalty (default 1.0)

SPM is Supply Pressure Multiplier (default 1.0)

$$\begin{aligned} \text{Supply Loss Factor} &= 0.5 * 1.0 * 1.0 \\ &= 0.5 \end{aligned}$$

Return Loss Factor = (RLS x RLP x RPM)

Where: RLS is Return Leakage Split (default 0.5)

RLP is Return Leakage Penalty (default 0.5)

RPM is Return Pressure Multiplier (default 1.0)

$$\begin{aligned}\text{Return Loss Factor} &= 0.5 * 0.5 * 1.0 \\ &= 0.25\end{aligned}$$

Definitions:

Leakage Split is the estimated fraction of total measured leakage, either on the supply side or the return side of the duct system

Supply Leakage Penalty: The default value is 1.0. This means that of the supply air leakage, all of its energy leads to the outdoors (i.e., none of its energy is regained back into the house). This number can be lowered if some of the energy from duct leakage leads back into the house.

Return Leakage Penalty: The default value is 0.5. This assumes that of the return air leakage, about half of its energy is lost to outdoors. (i.e., the other half of its energy is regained back into the house). This number can be raised if you suspect that there's actually more energy loss to the outdoors from the return side.

Estimate HVAC system airflow

Estimate the total airflow from the system documentation, measured through static pressure/fan curve, or by measuring system airflow using flow measuring techniques.

Calculate HVAC system loss (%)

$$\% \text{ HVAC System Loss} = \frac{\text{CFM}_{25} \text{ Leakage to outside} \times (\text{Supply Loss Factor} + \text{Return Loss Factor})}{\text{Estimated System Airflow in CFM}}$$

Example 1:

We conduct a Duct Leakage to Outdoors Test on a 3 ton, 11 SEER heat pump system (supplies located in the attic and returns in the crawlspace). The owners report a \$1300/yr cooling bill and a \$700/yr heating bill. Using 25 Pa as our duct testing pressure, we measure 270 CFM₂₅ of duct leakage to the outside. We measure a total system airflow of 1425 CFM using a total flow measurement method. We will use the default values for Supply/Return Loss Factors.

$$\% \text{ HVAC System Loss} = \frac{270 \text{ CFM} \times (0.5 + 0.25)}{1425 \text{ CFM}}$$

$$\% \text{ HVAC System Loss} = 14\%$$

$$\text{Annual cooling loss} = 14\% \times \$1300 = \$182$$

$$\text{Annual heating loss} = 14\% \times \$500 = \$70$$

$$\text{Annual capacity loss} = 14\% \times 3 \text{ ton} = 0.42 \text{ tons}$$

$$\text{Annual operating SEER} = (1 - 14\%) \times 11 \text{ SEER} = 9.5 \text{ SEER}$$

Example 2:

For the same house measured above, the correct leakage split is determined with the majority of leakage on the return side at 200 CFM. Assume the average operating pressure for the return side is closer to 35 Pa because it is close to the plenum takeoff.

$$\text{CFM}_{25} \text{ multiplier for return} = 1.22$$

$$\text{CFM}_{25} \text{ multiplier for supply} = 1.0 \text{ (default)}$$

Leakage splits:

$$\text{SLS} = 200 \text{ CFM}_{25} / 270 \text{ CFM}_{25} = 0.74$$

$$\text{RLS} = 70 \text{ CFM}_{25} / 270 \text{ CFM}_{25} = 0.26$$

Loss Factors:

$$\text{SLF} = (0.74 \times 1.0 \times 1.22) = 0.9$$

$$\text{RLF} = (0.26 \times 0.5 \times 1.0) = 0.13$$

$$\begin{aligned} \% \text{ HVAC System Loss} &= \frac{270 \text{ CFM} \times (0.9+0.13)}{1425 \text{ CFM}} \\ &= 20\% \end{aligned}$$

$$\text{Annual cooling loss} = 20\% \times \$1300 = \$260$$

$$\text{Annual heating loss} = 20\% \times \$500 = \$100$$

$$\text{Annual capacity loss} = 20\% \times 3 \text{ ton} = 0.6 \text{ tons}$$

$$\text{Annual operating SEER} = (1 - 20\%) \times 11 \text{ SEER} = 8.8 \text{ SEER}$$

14. Field Check the DucTester to find out what is not working

Standard procedure says you calibrate your gauges every year or two, but does this really make sense? The gauge can be calibrated regularly but when did the gauge go out of calibration? Last week or last year?

There is a quick way to field-check your gauge regularly or before an important test. Gauge calibration, where errors are typically a few %, is not as frequent a cause of problems when compared to blocked, leaking or pinched tubes that happen more often and can yield errors of 10 or 90%. Sending your gauge in for calibration does not address those problems but doing a field check will.

14.1 Field Check the gauge

To verify the calibration of a gauge, the easiest method is to compare the readings of one channel with respect to the other channel. If the pressures are equal, then it is likely the gauge is accurate, because the chance of both channels being out of calibration by the same amount is very small.

To perform a cross port check

Download the Pressure Gauge Operation Manual for DM32 from:

<http://retrotec.com/sites/default/files/manual-guides-specs/Manual-DM32%20Operation.pdf>

and look at the Section named “Verify your gauge accuracy between factory calibrations”.

You will also Field Check the tubes using the procedure outlined there.

This test requires one color of tube be connected between channel A and B. If both channels don't display the same pressure or the pressure drops rapidly the tubes are blocked or leaking. Water can be whipped or blown out of tubes and crimped tubes can be adjusted.

If the readings are different, either one tube is blocked or the gauge is faulty. Try another tube to see if it's the tube or the gauge. Check each tube separately. If differences on the gauge persist with different tubes connected, repeat the test against another gauge. Only then should a gauge return be considered.

Pressure dropping to zero in 10 seconds or less indicates a leak somewhere; try another tube and try the same tube on a different port to see which piece is faulty, the tube or the gauge. If the tube end is damaged, slice 1/8 inch off the tube and try again.

The tubes have now all been checked, removing that major source of error.

14.2 Field Check the DucTester as a system

This check will ensure that the DucTester is connected properly, and will ensure that the measured results for flow are within 10% of the true value when using the DucTester as a system with Flex Duct. The flow verification plate is optional equipment, since a temporary one can be easily manufactured using thin, solid, cardboard with a 4" x 4 5/8" square hole (18.6 sq in) cut in the center. If making your own, a 1/4 inch diameter hole should be made in one corner of the plate, as far away from the larger hole as possible, into which the blue tube can be inserted.

To field check the DucTester calibration

1. Tape the Field Calibration Plate to the Flex Duct Flange, and attach the blue tube to the pressure pickup (or into the small cut hole if using a homemade one).
2. Install Range 74 Flow Plug and set same Range on the Gauge.
3. Attach the Flex Duct to the outlet side of the fan to pressurize the Flex Duct. If depressurizing ducts normally, you can also check the DucTester in that direction by attaching the flex to the inlet of the fan where you must connect the green reference tube.
4. Stretch the Flex Duct to its full length. Set the "Mode" to "Flow".
5. Press **[Set Pressure] [25] [Set]** and the fan will automatically control to 25 Pa. Press **[@]** to display "CFM @25 Pa".
6. Compare the measured results with the flow marked on the calibration plate. A homemade plate with the specified size hole should read within 5% of 105 CFM.

The calibrated fan and flex duct has now been checked as a system, removing that major source of error.

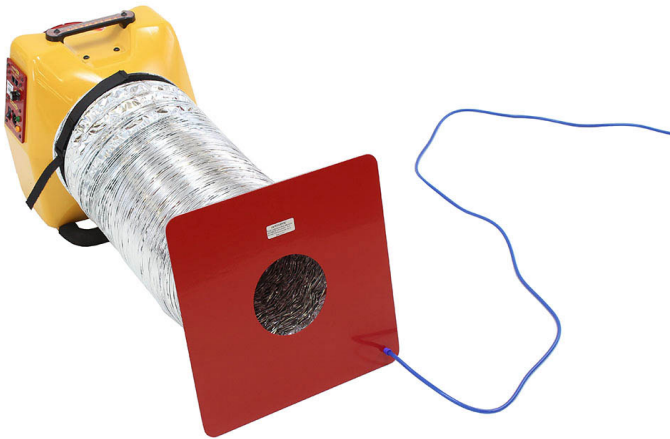

Figure 44: DucTester field calibration check setup.

Avoid common mistakes

The following mistakes are commonly made when performing a duct test, and can significantly affect the results.

- Wrong Range Configuration and or wrong Device selected on gauge
- Water in tube, pinched tube
- No green reference tube attached while depressurizing ducts
- Having @ Pressure on when setting the pressure on the DucTester to zero when measuring duct leakage to outdoors using method #2.
- Not covering all registers
- Not locating and sealing ducts running to outdoors such as fresh air supply ducts
- Tape sealing registers being blown off, usually happens in pressurization
- Furnace coming on during a test
- Too leaky to test accurately, although this is usually not an issue because tests can be performed accurately at twice the allowable duct leakage.
- Be aware of ducts with no leaks:

In some cases, especially in new construction, it is possible to find ducts that have no leaks. Some indications would be if even a very low fan speed results in a very high duct pressure, or if no flow can be measured with even the most restrictive Range Configuration. One way to verify that the test is

correct, and that the ducts are not leaky, is to unseal a single register. This introduces a leak to the duct system, which is measured by the equipment. If this test results in a measure leak of the approximate size of the opened register, the previous test is valid, and the system is too tight to measure any duct leakage.

- Method 2 duct leakage to outdoors or combined method has erratic readings:

Huge errors will result if the @ Pressure function is turned on during this test because it creates a divide by zero error. Press [@] to remove “@” from under the result. This method relies on the DucTester gauge measuring the pressure between the house and ducts which is set to zero by the DucTester but the extrapolation to zero that is attempted by the gauge will not work.

15. Create a Blower Door with a DucTester fan

15.1 Use a DucTester to test tight enclosures

To use your duct testing fan as a Blower Door system for testing tight enclosures you only need to add an Aluminum Frame and a Low-Flow Cloth Door Panel. If you have a DucTester system, your Umbilical will have blue, yellow and green tubes. In this case, the blue tube will be connected to the red port on the gauge and passed through the panel. The graphic in Figure 45 shows the umbilical that comes with a Blower Door system, with a red, yellow and green tube, and the red tube connected to the red gauge port and going through the panel to the outdoors. It is not necessary to change your Umbilical just for this color change.

Blower Door systems for testing tight enclosures should be set up as shown in Figure 45 below:

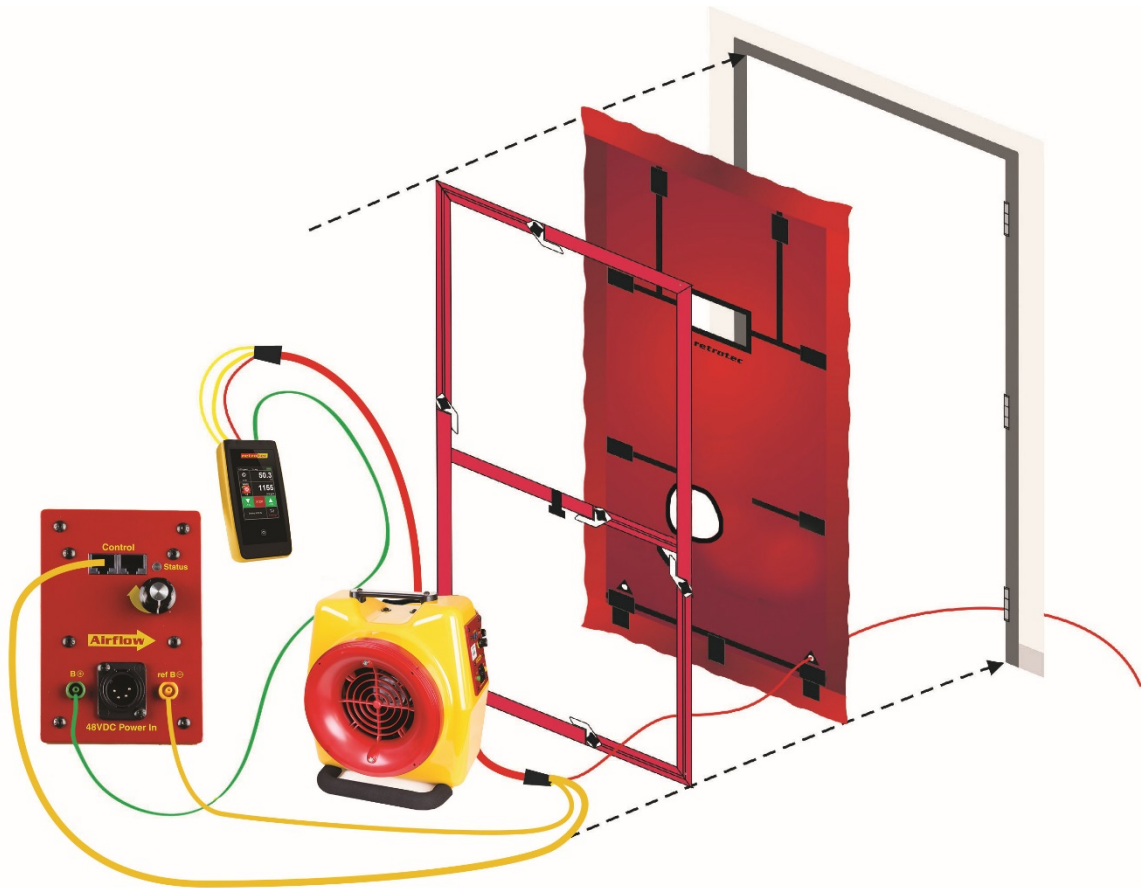

Figure 45: Blower Door setup using a Model 300 fan to test tight enclosures. The left image shows the Fan Top from a side view of the Model 300 fan with tubing and Control Cable connections.

The green tube is always recommended and must be connected if the flow is towards the operator (i.e., air is blowing towards where the operator is standing). The Speed Control Cable can be plugged into either one of the two Control ports.

To measure building envelope leakage with Blower Door testing, please refer to procedures outlined in Retrotec's *Manual-Door Fan Operation* and *QuickGuide-Blower Door*.

15.2 Blower Door systems for testing tight enclosures

Includes all of the parts listed above for a typical duct testing system, except instead of a Flex Duct, the Blower Door systems include an Aluminum Frame and Cloth Door Panel to tightly fit the Model 300 fan into a doorway. Also included is a hard-sided case for the Aluminum Frame. The gauge can be placed securely into the included gauge holder that holds it upright on the Aluminum Frame for easy access during a Blower Door test.



Figure 46: Blower Door system for testing tight enclosures.



To expand your DucTester into a Blower Door system for testing tight enclosures, you only need to add a Low-Flow Cloth Door Panel with Aluminum Frame.

Table 7: Aluminum Frame Door Panel dimensions

Dimensions	
Panel width	29 - 43.0 in (75 - 109 cm)
Panel height	53 - 97 in (135 - 246 cm)
Frame thickness	1.75 in (5.3 cm)
Frame case	53 x 10 x 4 in (134 x 25 x 10 cm)
Frame weight	19 lbs (8.6 kg)

Appendix A: Calculate Air Flow based on Channel B Fan Pressure readings

The air flow being produced by the calibrated fan is a value that can be calculated based on the pressure developed by the air moving across the inlet side of the fan towards the exhaust. Because the fan is calibrated, there are known values describing the mathematical relationship between the fan pressure, which is measured across the fan inlet, and the resulting air flow through the fan.

The Fan Pressure needed to calculate the fan flow is the difference between the pressure at the pickup and the pressure in the vicinity of the inlet side of the fan. The fan pressure pickup is located inside the fan near the inlet side of the fan. Self-referencing fans such as the DU300 have the reference port built in, and it is placed to measure the ambient pressure in the vicinity of the inlet side of the fan. It is important to set the Device on the gauge to DU300 because that tells the gauge not to adjust the “PrB” value before calculating flow. Such an adjustment is required in the case of flow toward the operator when the fan is not self-referenced.

Each fan and range combination has a different flow equation. For each fan and range combination available, the variables needed to calculate flow are listed in the table below. *N* and *K* values depend on the type of fan and the Range Plate/Ring being used.

Since both the fan pressure pickup and the reference for the fan pressure (yellow and green ports on the fan connected to the gauge) are on the inlet side of the fan, “PrB”, will always show the correctly referenced fan pressure and can be used directly as the fan pressure, *FP*, value in the flow equation.

To determine the fan flow for a particular Fan Pressure, insert the values measured for *FP* and *DP*, and the *N* and *K* values from the table into the following equation:

$$\text{Flow CFM} = (FP - DP \times K1)^N \times (K + K3 \times FP)$$

Where: *FP* is the fan pressure from Channel B displayed as “PrB”

DP is the duct pressure from Channel A displayed as “PrA”

There are two conditions for *FP* that must be met before the calculated flow can be considered valid. The absolute value of *FP* must be greater than the minimum fan pressure, *MF*, from the table and greater than a factor calculated from the duct pressure, *DP*, and *K2* from the table:

So before calculating flow ensure that: $|FP| > MF$ And: $|FP| \geq |DP| \times K2$

Table 8: N and K coefficients for all supported fans in the gauge.

	Range	n	K	K1	K2	K3	MF	
Model 300	Open	0.5150	27.9000	0	0.04	0	10	
	102	0.5100	17.0000	0.001	0.072	-0.0002	18	Range 102 is not available for Model 340
	74	0.5000	7.0500	0	0.16	0.0001	40	
	47	0.5000	2.9400	-0.010	0.1	0.0001	25	
	29	0.5000	1.1920	0	0.036	0	9	
	18	0.5000	0.4420	-0.010	0.036	0	35	These Ranges are optional for Model 340
	11	0.5300	0.1464	-0.070	0.18	0	45	
	7	0.4450	0.0810	0	0.10	0.00002	25	
	3	0.4450	0.01812	0	0.10	0.000007	25	
	2	0.4450	0.00417	0	0.10	0.000003	25	
1	0.4450	0.00104	0	0.10	0.000001	25		

Appendix B: Flow Conversion Tables

Flow Conversion Table for Duct Test Pressure of 25 Pa

Table 9: Flow in CFM for various fan pressures, Retrotec Model 300 Fans, Duct Test Pressure: 25 Pa (relative to outdoors)

Flow AWAY or TOWARDS operator, both green and yellow tubes connected.

Fan Pressure (Pa)	Range			
	Open	74	47	29
10	91.3	---	---	3.8
12	100.3	---	---	4.1
14	108.6	---	---	4.5
16	116.3	---	---	4.8
18	123.6	---	---	5.1
20	130.5	---	---	5.3
22	137.1	---	---	5.6
24	143.4	---	---	5.8
26	149.4	---	15.1	6.1
28	155.2	---	15.6	6.3
30	160.8	---	16.2	6.5
32	166.2	---	16.7	6.7
34	171.5	---	17.2	7.0
36	176.6	---	17.7	7.2
38	181.6	---	18.2	7.3
40	186.5	44.6	18.7	7.5
42	191.2	45.7	19.1	7.7
44	195.9	46.8	19.6	7.9
46	200.4	47.8	20.0	8.1
48	204.9	48.9	20.5	8.3
50	209.2	49.9	20.9	8.4
52	213.5	50.9	21.3	8.6
54	217.7	51.8	21.7	8.8
56	221.8	52.8	22.1	8.9
58	225.8	53.7	22.5	9.1
60	229.8	54.7	22.9	9.2
62	233.7	55.6	23.2	9.4
64	237.6	56.5	23.6	9.5
66	241.4	57.3	24.0	9.7
68	245.1	58.2	24.3	9.8
70	248.8	59.0	24.7	10.0
72	252.4	59.9	25.1	10.1
74	256.0	60.7	25.4	10.3
76	259.6	61.5	25.7	10.4
78	263.0	62.3	26.1	10.5
80	266.5	63.1	26.4	10.7
82	269.9	63.9	26.7	10.8
84	273.3	64.7	27.1	10.9
86	276.6	65.5	27.4	11.1
88	279.9	66.2	27.7	11.2
90	283.2	67.0	28.0	11.3
92	286.4	67.7	28.3	11.4
94	289.6	68.4	28.6	11.6

Fan Pressure (Pa)	Range			
	Open	74	47	29
96	292.7	69.2	28.9	11.7
98	295.9	69.9	29.2	11.8
100	299.0	70.6	29.5	11.9
105	302.0	71.3	29.8	12.0
110	305.1	72.0	30.1	12.2
115	308.1	72.7	30.4	12.3
120	311.0	73.4	30.7	12.4
125	314.0	74.1	31.0	12.5
130	316.9	74.7	31.3	12.6
135	319.8	75.4	31.5	12.7
140	322.7	76.1	31.8	12.8
145	325.6	76.7	32.1	12.9
150	328.4	77.4	32.4	13.1
155	331.2	78.0	32.6	13.2
160	334.0	78.6	32.9	13.3
165	336.7	79.3	33.2	13.4
170	339.5	79.9	33.4	13.5
175	342.2	80.5	33.7	13.6
180	344.9	81.1	34.0	13.7
185	347.6	81.8	34.2	13.8
190	350.2	82.4	34.5	13.9
195	352.9	83.0	34.7	14.0
300	355.5	83.6	35.0	14.1
205	358.1	84.2	35.2	14.2
210	360.7	84.8	35.5	14.3
215	363.3	85.4	35.7	14.4
220	365.8	85.9	36.0	14.5
225	368.4	86.5	36.2	14.6
230	370.9	87.1	36.5	14.7
235	373.4	87.7	36.7	14.8
240	375.9	88.2	36.9	14.9
245	378.4	88.8	37.2	15.0
250	380.8	89.4	37.4	15.1
255	383.3	89.9	37.7	15.2
260	385.7	90.5	37.9	15.3
265	388.1	91.0	38.1	15.4
270	390.5	91.6	38.4	15.5
275	392.9	92.1	38.6	15.5
280	395.3	92.7	38.8	15.6
285	397.6	93.2	39.0	15.7
290	400.0	93.8	39.3	15.8
295	402.3	94.3	39.5	15.9
300	404.6	94.8	39.7	16.0

Appendix C: Calculate flow if required test pressure cannot be reached

“n” setting for estimating flow @ pressure during house and duct leakage test

Houses and ducts have leaks through holes that will have both turbulent and laminar flow going through them. The relationship between pressure and flow is as follows:

$$\text{flow} = \text{Pressure}^n \times C$$

The actual flow exponent n for an enclosure can be calculated by measuring enclosure leakage at multiple pressure differences, from 10 to 50 Pa, and determining the slope of the line when graphing log of flow versus log of pressure. The graph of pressure versus flow will be linear if graphed on a log-log scale, and the slope will be n . The constant C is a value depending on the flow characteristics of the opening through which the air is moving, and can be thought of as the flow at 1 Pa. Once n is known, flow at 1 Pa can be found using the graph.

A wide open hole has an n of 0.5, meaning that when the pressure is quadrupled, the flow doubles. That is due to completely turbulent flow going through that hole (flow = square root of pressure, a constant for that particular hole).

$$\text{flow} = \text{Pressure}^n$$

$$\text{flow} = \text{Pressure}^{0.5}$$

An n value of 1.0 represents tiny little holes, so small that the air would not be turbulent but rather would go through the holes as laminar flow. This means that when pressure is quadrupled, the flow will also be quadrupled.

$$\text{flow} = \text{Pressure}^1$$

$$\text{flow} = \text{Pressure}$$

$$4 * \text{flow} = 4 * \text{Pressure}$$

Duct holes tend to be slightly larger so tend towards more laminar with less turbulent flow and larger n values, whereas houses have more prevalent long tiny cracks, and therefore tend to have lower n values.

The n value is saved in the gauge. Set it to 0.65 for houses, and 0.60 for ductwork. Set to 0.5 for tests on the Retrotec house simulator, while measuring air handler flow and for any large hole that is not composed of long thin cracks.

The gauge uses the n value to extrapolate for flows at other pressures using the following formula:

$$\text{Flow at desired test pressure} = (\text{Flow at measured pressure}) * \left(\frac{\text{desired test pressure}}{\text{measured pressure}} \right)^n$$

Note that because the formula is using a ratio of the two pressures, and both pressures will have the same C , the C value is not required for the extrapolation.

For example: If we guess at the n value of a duct as being 0.6 and measure 100 CFM at 20 Pa (by accident or by design), then the gauge will complete the following calculation to estimate the flow at 25 Pa:

$$\text{flow@25 Pa} = \text{flow@20 Pa} \times \frac{25^{0.6}}{20^{0.6}}$$

If the test pressure (20 in this case) is close to the desired reference pressure (25 Pa in this case), then the correction is small and the value of n does not play as large a role. However, if the test pressure is much higher or lower than the reference pressure, the error can be greater.

The @ Pressure extrapolation feature is very useful for ensuring that results taken for flow reflect the flow at the desired test pressure, even when the pressure was not adjusted perfectly and was within 5 to 10 Pa of the desired test pressure.

Extrapolation Error for Flow if gauge “n” doesn’t match actual n

To continue the above example: The flow at 20 Pa is 100 CFM. Assume the actual n is 0.7, but this is unknown. If the user chooses the 340 device, n-value of 0.6 will be used.

The gauge would calculate:

$$\text{Flow@25 Pa} = \frac{25^n \times \text{CFM}}{20^n}$$

$$\text{Flow@25 Pa} = \frac{25^{0.6} \times 100}{20^{0.6}}$$

$$\text{Flow@25 Pa} = 114 \text{ CFM}$$

However, if actual n was 0.7, the flow at 25 should have been:

$$\text{Flow@25 Pa} = \frac{25^{0.7} \times 100}{20^{0.7}}$$

$$\text{Flow@25 Pa} = 117 \text{ CFM}$$

This value is less than 3% off from what it should be. If the test pressure was within 1 or 2 Pa of the reference pressure of 25 Pa, the @ Pressure reading would be exact.

If a gauge has the extrapolation or flow exponent “n” set to an assumed value but the actual exponent (the true exponent value that describes the enclosure) differs, the flow values estimated by the gauge when extrapolating will be off by a small error amount. The tables below show the percent error that can result from entering an incorrect exponent value in the gauge and using the [**@ Pressure**] function.

If the “n” value on the gauge is set to 0.65 and the actual duct “n” is different, a small error, as shown in **Error! Reference source not found.** will result if the [**@ Pressure**] function is used at the Achieved Pressure to estimate a result at 50 Pa.

If the “n” value on the gauge is set to 0.60 and the enclosure “n” is different, a small error, as shown in Table 10 will result if the [**@ Pressure**] function is used at the Achieved Pressure to estimate a result at 50 Pa.

Table 10: Errors in Estimated Flow at 50 Pa if gauge “n” = 0.60 differs from actual n

Assumed n = 0.6	Achieved Pressure (Pa)	Actual Flow Exponent (n) of Enclosure					
		0.50	0.55	0.60	0.65	0.70	0.75
	10	-14.9%	-7.7%	0.0%	8.4%	17.5%	27.3%
	15	-11.3%	-5.8%	0.0%	6.2%	12.8%	19.8%
	20	-8.8%	-4.5%	0.0%	4.7%	9.6%	14.7%
	25	-6.7%	-3.4%	0.0%	3.5%	7.2%	11.0%
	30	-5.0%	-2.5%	0.0%	2.6%	5.2%	8.0%
	35	-3.5%	-1.8%	0.0%	1.8%	3.6%	5.5%
	40	-2.2%	-1.1%	0.0%	1.1%	2.3%	3.4%
	45	-1.0%	-0.5%	0.0%	0.5%	1.1%	1.6%
	50	0.0%	0.0%	0.0%	0.0%	0.0%	0.0%

Assumed n = 0.6	Achieved Pressure (Pa)	Actual Flow Exponent (n) of Enclosure					
		0.50	0.55	0.60	0.65	0.70	0.75
	55	1.0%	0.5%	0.0%	-0.5%	-0.9%	-1.4%
	60	1.8%	0.9%	0.0%	-0.9%	-1.8%	-2.7%
	65	2.7%	1.3%	0.0%	-1.3%	-2.6%	-3.9%
	70	3.4%	1.7%	0.0%	-1.7%	-3.3%	-4.9%

Achieved pressure is the actual maximum pressure achieved in the enclosure (ducts in this case) during the test.

$$\text{Error} = \left(\frac{\text{Pressure of Interest}}{\text{Achieved Pressure}} \right)^{(\text{Actual } n - \text{Assumed } n)}$$

In the tables, the *Pressure of Interest* is 50Pa, and *Assumed n* is 0.65 or 0.60

The actual flow exponent *n* for an enclosure can be calculated by measuring enclosure leakage at multiple pressure differences, from 10 to 50 Pa, and determining the slope of the line on the graph of pressure versus flow which will be linear if graphed on a log-log scale, and the slope will be *n*.

Cannot Reach 25 Pa Factors

If you have a situation where you cannot reach the required 25 Pa during the test, there is a way to estimate the flow at that pressure based on the measured pressure and flow you did achieve. This is the procedure the gauge uses for extrapolating the flow at the required pressure when you use the [Ⓜ] key. The following equation describes the relationship between the flow at the required pressure of 25 Pa and the actual measured flow at the measured pressure:

$$\text{Flow at 25 Pa} = (\text{Flow at measured pressure}) * \left(\frac{25 \text{ Pa}}{\text{measured pressure}} \right)^n$$

$$\text{CFM}_{25} = \text{CFM}_P * \left(\frac{25}{P} \right)^n$$

For most ducts, the *n* value is usually 0.60. For the flow at 50 Pa, replace "25" with "50."

Rather than using the equation in the situation where the 25 Pa test pressure cannot be achieved, you can use tables with the factors already calculated and the following procedure.

Take a flow (CFM) reading at the pressure achieved and multiply by the "Cannot reach 25 Pa factor" from Table 11 to get an estimate of the flow that would result at 25 Pa.

For example: if you read 600 CFM at a building pressure of 19 Pa, the "Cannot reach 25 factor" from Table 11 is 1.18. To get the estimated flow at 25 Pa, make the following calculation:

$$600 \text{ CFM} \times 1.18 = 708 \text{ CFM}$$

Thus the estimated result for CFM at 25 Pa will be 708 CFM.

The factors depend on the *n* value chosen. Table 11 is for *n* of 0.60 which is typical for ducts.

Table 11: Factors for when a duct pressure of 25 Pa cannot be reached (assumed *n* value of 0.6).

Pressure achieved	Cannot reach 25 factor
25	1.00
24	1.02
23	1.05
22	1.08
21	1.11
20	1.14
19	1.18
18	1.22
17	1.26
16	1.31
15	1.36
14	1.42
13	1.48
12	1.55
11	1.64
10	1.73
9	1.85
8	1.98
7	2.15
6	2.35
5	2.63

Cannot Reach 50 Pa Factors

Rather than using the equation in the situation where the 50 Pa test pressure cannot be achieved, you can use tables with the factors already calculated and the following procedure. Take a flow (CFM) reading at the pressure achieved and multiply by the "Cannot reach 50 Pa factor" from Table 12 to get an estimate of the flow that would result at 50 Pa.

For example, if you read 1000 CFM at a building pressure of 30 Pa, the "Cannot reach 50 factor" from Table 12 is 1.36. To get the estimated flow at 50 Pa, make the following calculation:

$$1000 \text{ CFM} \times 1.36 = 1360 \text{ CFM}$$

Thus the estimated result for CFM at 50 Pa will be 1360 CFM.

The factors depend on the "*n*" value chosen, and Table 12 is for "*n*" of 0.60 which is typical for ducts.

Table 12: Factors for when a duct pressure of 50 Pa cannot be reached (assumed "*n*" value of 0.60).

Pressure achieved	Cannot reach 50 factor
50	1.00
49	1.01

Pressure achieved	Cannot reach 50 factor
25	1.52
24	1.55

Pressure achieved	Cannot reach 50 factor
48	1.02
47	1.04
46	1.05
45	1.07
44	1.08
43	1.09
42	1.11
41	1.13
40	1.14
39	1.16
38	1.18
37	1.20
36	1.22
35	1.24
34	1.26
33	1.28
32	1.31
31	1.33
30	1.36
29	1.39
28	1.42
27	1.45
26	1.48

Pressure achieved	Cannot reach 50 factor
23	1.59
22	1.64
21	1.68
20	1.73
19	1.79
18	1.85
17	1.91
16	1.98
15	2.06
14	2.15
13	2.24
12	2.35
11	2.48
10	2.63
9	2.80
8	3.00
7	3.25
6	3.57
5	3.98

Appendix D: Troubleshooting

Occasionally simple problems do occur with a DucTester system. If the problem is described in any of the following sections, follow the steps to attempt to resolve the problem. If the problem persists, contact support@retrotec.com.

“--” appears on display:

Backpressure refers to the pressure that the DucTester fan works against while running. Under most testing conditions, backpressure is not a concern. If the backpressure is too great, the DM32 gauge will automatically sense it and display “--”, indicating the fan pressure signal is too low compared to the pressure the fan is working against. Changing to a more restrictive Range Configuration will solve this problem.

Gauge “Flow” reading does not change? Turn off [Ⓜ]

When the measured flow or fan pressure does not increase as fan speed increases the gauge has likely been set to calculate a value for result extrapolation. To remove result extrapolation, press the [Ⓜ] button until “is Off” is shown.



If [Ⓜ] is active, the gauge calculates a reading for flow at the extrapolation pressure, no matter what the actual “PrA” measures. Therefore, regardless of fan speed, the measured flow will appear relatively unchanging.

Fan does not run

Make sure the power light is on and the power switch is set to “1”. If the yellow Speed Control Cable (Ethernet-style) has been connected previously to a gauge, the Speed Control Knob must be turned off and then on again. This is a fail-safe feature so the fan does not go on unless you want it to.

Alternatively, turning the power switch off and back on will activate the Speed Control Knob as long as the Speed Control Cable is not connected.

Checking the DucTester flows

Set the gauge to Pressure on both channels by tapping Channel B.

Establish a test pressure of at least 25 Pa in a box or duct with flex duct connected to the DucTester fan and using the manual Speed Control Knob to pressurize. Disconnect the blue tube and connect it to the yellow port on the gauge. “PrB” should now read the same 25 Pa. If higher by a significant amount, then Channel A is leaking, but if lower then Channel B is leaking.

With the Flex Duct removed, set the fan to full speed. With the yellow tube connected to the fan and gauge on Channel B, the gauge should read over 700 Pa. If the value is a lot lower, Channel B is leaking. Connect the blue tube to “Input A” on the DM32, and “Ref B” on the fan which is the yellow port. (Yellow tube is disconnected.) Channel A should read about 700 Pa and if not Channel A is leaking.

Adjusting the fan Inlet Nozzle if is rubbing or debris needs to be removed from fan

Remove the tape holding the Nozzle in place. Clean and replace with new tape as supplied with your system.

If your impeller is rubbing. Remove the Inlet Nozzle. Loosen the mounting bolts. Cover the impeller with 0.10 inches of paper or card stock. Retighten the bolts. Remove the nozzle and the paper and replace the nozzle with tape to hold it in position.



Tape replacement method shown above. Using the roll of special tape supplied, start underneath the nozzle inlet, wrap tape around and finish by smoothing down as shown below.



Appendix E: Using a generator for power

Retrotec recommends a generator with inverter type AC power output. Size the generator capacity above the maximum power required in order to reduce distortion of the AC power waveform. The higher the rated power output, the better. Suggestions for minimum generator output sizes are 3000W for Blower Doors and 500W for DucTesters.



When selecting the generator, look for key words and phrases including:

- “inverter output”
- “utility-grade AC power”
- “suitable for sensitive electronics”

Table 13: Portable generator AC power output types.

Type of AC Power Output	Comments/Expectation	
Inverter	Best; Compatible	Recommended
AVR – Automatic Voltage Regulation	Questionable; May not perform	Not Recommended
Brushless	Worse; May not perform	Not Recommended
CycloConverter	Worst; May not perform	Not Recommended

Generators

<p>Honda Generator EU3000 (120V, 2000W, 67 lbs)</p> <ul style="list-style-type: none">• Works with all DucTester fan models.• Works with both 2200 and 2350 series fans. <p>The Honda EU3000 provides 3000 watts and 120V AC power. It is equipped with an inverter, and is specially designed for sensitive electronic equipment. At 16.7 Amps, it meets the needs of most Retrotec equipment.</p>	 A red and black Honda EU3000 portable generator with a carrying handle on top and various outlets on the front panel.
<p>GENYX G3000HI (230V, 3000W) generator</p> <ul style="list-style-type: none">• Works with all Retrotec Fans. <p>The G3000HI is equipped with an inverter, and runs at 230V and a maximum of 3000W for even the most powerful Retrotec equipment.</p>	 A yellow and black GENYX G3000HI portable generator with a carrying handle on top and a control panel on the front.

Portable Power Supplies

Portable power supplies can provide enough power for Retrotec DucTester fans, but are unlikely to produce sufficient power for a Blower Door. Please ensure that the power supply meets the minimum power requirements of the fan before attempting to use one.

<p>Black and Decker Electromate 400 Model VEC026BD</p> <ul style="list-style-type: none">• ONLY use with DucTesters with a 2350 Fan Top (per label). <p>The VEC026BD is a 110/120VAC power supply with a built in 400W inverter.</p>	 A red and black Black and Decker Electromate 400 portable power supply with a carrying handle and various outlets.
---	--

Appendix F: Duct-Test Recording Forms

Total Duct Leakage Test Form

Test date: _____/20____

Fan Model _____ Fan Serial # _____ Digital Gauge Serial # _____

Address: _____ Contact: _____ Phone: _____

Technician: _____

Step	√		More details and check off
1		Position DucTester near return	Ensure the flex will reach the return grill
2		Turn Air-handler off (if installed)	Put your car keys beside the switch so you remember to turn back on
3		Remove the furnace filter and cover filter opening	
4		Attach flex to return register or access door in the air handler	Attached to __ return register, __ access door
6		Seal all registers	
7		Insert blue tube in a supply register	__ attached to register closest to plenum
8		Open interior and one exterior door	To make indoor and outdoor pressure the same
9		Make connections to the DucTester	__ yellow tube, __green tube, __ power cord, __ speed control
10		Connect tubes and speed control to the gauge	__ blue tube, __ yellow tube, __green tube, __ speed control
11		Enter conditioned floor area of the house into gauge	_____ sq ft conditioned floor area
12		Create a 25 Pa pressure in the ducts	Press [Set Pressure], [25], and [Enter]. Press [@] to display “@ 25 Pa”
13		Range Configuration, usually it will be Range 74	_____
14		Record Pressure (PrA) and Flow Record Flow with @ 25 Pa displayed. Record n and Time Avg displayed.	_____ Pa _____ CFM with NO @ 25 _____ CFM @ 25 ___ n and ___ seconds of Time Average displayed.
15		Record Flow Direction	__ flow into ducts, __ out of the ducts
16		Record CFM/100 sq ft	_____ CFM/100 sq ft
17		Maximum Allowable duct leakage __ Post Construction: 12 CFM/100 sq ft __ Rough in Air handler installed: 6 CFM/100 sq ft __ Rough in Air handler not installed: 4 CFM/100 sq ft	___ Pass, ___ Fail.
18		Remove tape, turn HVAC equipment back ON	Return home to state you found it in

Recording form based on IECC 2009

Total Duct Leakage Test Form (CA)

Test date:

_____/20____

Fan Model _____ Fan Serial # _____ Digital gauge Serial # _____

Address: _____ Contact: _____ Phone: _____

Technician: _____

The DucTester measures the total leakage of a duct system by pressurizing all ducts to 25 Pascals with the air-handler off and the registers taped over.

Step ↓	... √		Detailed Description of the Step
1		Position DucTester near return	Ensure the flex will reach the return grill
2		Turn Air-handler off	Put your car keys beside the switch
3		Remove the furnace filter	Cover filter opening
4		Attach Flange + flex to return register	... or __ access door in the air handler
6		Insert blue tube in a supply register	
7		Seal all other registers	Do NOT seal to the wall or ceiling.
8		Open doors or windows	
9		Connect the DucTester	__ yellow tube, __ power cord, __ speed control, __green tube.
10		Connect the DM-2	
11		Turn on and set up the DM-2	
12		Create a 25 Pa pressure in the ducts	
13		Range Configuration	_____
14		Record Flow and Pressure Record Flow with @ 25 Pa displayed. Record n and Time Avg displayed.	____ CFM, ____ Pa with NO @ Pressure displayed. ____ CFM, __ @ 25 feature used. ____ n and ____ seconds of Time Average displayed.
15		Record Flow Direction	____ pressurize with flow into ducts, __depressurize
16		Maximum Allowable duct leakage (per next page) is:	____ CFM, ____ Pass, ____ Fail.
17		Remove tape	Remove tape from registers.
18		Turn HVAC equipment back ON	Re-install the furnace filter and turn all HVAC equipment back ON

Recording form based on CA Title 24

New duct systems must leak less than 6% of the air handler's flow.

Maximum allowable duct tester measurement based on 3 different base system air handler flow is:

For A/C systems multiply the Tonnage X 24 CFM. Assumes 400 CFM per Ton with maximum allowable leakage of 6% = 24 CFM per Ton. E.g. a 5 Ton system must have less than 5 X 24 = 120 CFM of leakage at a 25 Pa test pressure in the supplies.	TONNAGE ____ X 24 = ____ CFM
For Heating systems divide the BTU /1000 X 1.302 CFM. Assumes 21.7 CFM per 1000 BTU capacity with maximum allowable leakage of 6% = 1.302 CFM per 1000 BTU. E.g. a 100,000 BTU furnace must less than 100,000 / 1000 X 1.302 = 132 CFM of leakage.	BTU _____ /1000 X 1.302 = ____ CFM
Measure the fan flow divided by 100 X 6. E.g. an air-handler blower flow of 2000 CFM must have less than 2000 / 100 X 6 = 120 CFM of leakage.	Measured fan flow _____ / 100 X 6 = ____ CFM

Existing duct systems must leak less than 15% of the air handler's flow.

The Maximum allowable duct tester measurement based on 3 different base system air handler flow is:

For A/C systems multiply the Tonnage X 60 CFM. Assumes 400 CFM per Ton with maximum allowable leakage of 15% = 60 CFM per Ton. E.g. a 5 Ton system must have less than 5 X 60 = 300 CFM of leakage at a 25 Pa test pressure in the supplies.	TONNAGE ____ X 60 = ____ CFM
For Heating systems divide the BTU /1000 X 3.255 CFM. Assumes 21.7 CFM per 1000 BTU capacity with maximum allowable leakage of 15% = 1.302 CFM per 1000 BTU. E.g. a 100,000 BTU furnace must have less than 100,000 / 1000 X 3.255 = 326 CFM of leakage.	BTU _____ /1000 X 3.255 = ____ CFM
Measure the fan flow divided by 100 X 15. E.g. an air-handler blower flow of 2000 CFM must have less than 2000 / 100 X 15 = 300 CFM of leakage.	Measured fan flow _____ / 100 X 15 = ____ CFM

Glossary

Term	Definition
ACH50 or ACH @ 50 Pa	Designation for “Air Changes at 50 Pa.” Can be calculated by taking CFM50 x 60 minutes/hour, and dividing by the house volume
Aluminum Frame	Describes a frame over which cloth is stretched to provide a Door Panel closure for air leakage testing in buildings
Baseline pressure	Pressure that exists when the enclosure has been prepared for the test, but before the fan is activated. There is always some Baseline pressure due to stack, wind, flues and active HVAC systems. There are two components of Baseline pressure. A fixed Baseline offset (usually due to stack or HVAC) and a fluctuating pressure (usually due to wind or elevator operation). A method determining Baseline pressure is by having a digital gauge accumulate readings over an adjustable time period (Note: The terms “static pressure”, “bias pressure,” and “zero Fan Pressure difference” are used interchangeably with the term Baseline Pressure in other documents/standards used in the industry.)
Blower	The Retrotec fan unit that induces air flow and provides a Fan Pressure signal from which flow is measured.
CFM	Units: Cubic feet per minute (the units of volumetric flow)
CFM50 or CFM @ 50 Pa	CFM @ 50 Pa is the flow rate, in cubic feet per minute, required to depressurize/pressurize the building to 50 Pascals.
Conditioned Space	An area or volume that is normally air-conditioned or heated (i.e. inside the thermal envelope). Even though supply ducts may not discharge directly into these spaces, they are considered “conditioned” if their temperature follows indoor temperature closer than outdoor. (e.g., Any space maintained above 50°F in winter and below 80°F in summer)
Control port	Ethernet port on a Retrotec fan, labeled “Control”
Depressurization	The process of creating a negative pressure in the enclosure by blowing air out of it. Air is drawn in from outside to replace it, showing up as “geysers” when checked with an air current tester.
digital gauge	A gauge with an electronic pressure sensor and digital display that is capable of reading in tenths of a Pascal.
DOE	U.S. Department of Energy
Blower Door	A test instrument that fits into an open doorway in order to pressurize or depressurize an enclosure. It is a calibrated fan capable of measuring air-flow, and is used while mounting it into a doorway. A Blower Door is often called a “Door Fan” or an “Infiltrometer™”. The term “Door Fan” is more descriptive than the common term “blower door”, since the apparatus is a “fan” in a door, and since it does not use a “blower.”
Door Panel	A solid or flexible panel used to temporarily seal off a door way while allowing for the installation of a fan for the purpose of blowing air into the building in order to measure the air leakage rate or to provide a pressure to assist in the location of air leaks.
effective leakage area	A common term used to describe air flow at a pressure by equating it to an equivalent size hole in an elliptical nozzle that would pass the same air flow at the same test pressure. It is usually referenced to 4 Pa and incorporates a 1.0 discharge coefficient. It is typically about half the size of an equivalent leakage area that describes the same air flow rate. See ASTM E779-10, eq. (5).
enclosure	The surface bounding a volume, which is connected to outdoors directly. For example an apartment whose only access to outdoors was through a doorway that leads directly outdoors. If a building contains a series of apartments or offices whose only access to the outdoors is through a common hallway then the enclosure would be the volume that bounds all of the apartments or offices.
Envelope	The surfaces composed of floor and walls and floors that separate the test volume from volume surrounding the test volume. Also see “enclosure”
Equivalent Leakage Area (ELA or EqLA)	In layman’s terms, the ELA is the size of hole we’d have if all the building’s cracks and holes could somehow be brought together. Also called: Whole Room Leakage and includes leaks through the ceiling and below the ceiling (BCLA). In Engineer’s terms: the equivalent size of hole required in a flat plate to give the same flow rate having a discharge coefficient of 0.61 and taken at the Reference Pressure. This ELA is sometimes called the EqLA or Canadian ELA because it was first used in the Canadian GSB air leakage standard for houses. This ELA enjoys worldwide acceptance by

Term	Definition
	<p>most testers, even in the US. This ELA should not be confused with another ELA that is often called the EflA or Effective Leakage Area. It is very unfortunate that both these ELA's have the same acronym of ELA. The EflA was developed for the US ASTM Standard and is smaller than the EqLA by at least a factor of 0.61 because it uses a discharge coefficient of 1.0. This EflA is sometimes called the LBL or Lawrence Berkley Labs ELA because it was developed there and is used in the LBL natural Air Change model that enjoys wide usage apart from that usage, the EflA is not used very much but the existence of both can create huge problems.</p> <p>When it is taken at a Reference Pressure of 75 Pa, it is often referred to as EqLA75. EqLA is typically about twice the size of an effective leakage area that describes the same air flow rate. See ASTM E779-10, eq. (5).</p>
Fan Pressure	The pressure difference between the inlet side of the fan and the interior of the fan. This pressure can be read as "PrB" from Channel B on the gauge. It is used by the computer to calculate the air flow rate through the Blower Door.
Fan Top	Part on the fan where the fan's tubing, Control Cable, and power connections are. The Fan Top for the Model 200 refers to the two mounted red plates attached to the sides of the fan. Attached behind them are Printed Circuit Boards (PCBs). In this manual, we will refer to the "Control PCB assembly" as the one that has "Control" printed on the mounting plate. We will refer to the "Power PCB assembly" as the one with the power switch on it, and has "Mains Power" printed on it.
HVAC	Heating Ventilating and Air conditioning.
Leakage	A general term used to describe holes or the area of holes in in the envelope around an enclosure.
Leakage Area	This is the same as "Leakage" but expressed in sq ft or m ² .
LEED	Leadership in Energy and Environmental Design
Low-Flow Cloth Door Panel	Cloth Door Panel used to test tight enclosures with a Model 200 fan
Manual Speed Control Knob	The dial that is on a Fan Top to control fan speed
Open Range	A Range configuration on a Retrotec Blower Door that has no Range Rings or Range Plates attached. It is sometimes referred to as Open (22) Range since it's diameter is 22 inches.
outdoors	Outside the building in the area around the building.
Pascal (Pa)	Often shown as "Pa". A very small metric unit of pressure. There are 249 Pascals in 1 inch Water Column (the pressure required to push water up 1 inch in a tube). One Pascal = 0.000145 psi.
Pressurization	The process of creating a positive pressure in the house by blowing air into the enclosure. Air is pushed out through all the leaks, causing the smoke to move away from the operator when checked with an air current tester.
Range Configuration	The plastic Range attachments on the Retrotec Fan. On the Model 340, Range Configurations available are Ranges: Open, 74, 47, 29, 18, 11, 7, 3, 2 and 1.
reading	A set of simultaneous Room Pressure and Fan Pressure measurements. Sometimes referred to as a data set or test point because it is plotted as one point on a graph.
reference pressure	The pressure at which the ELA is calculated, usually at the test pressure.
room	See "Enclosure".
room pressure	The pressure difference created by the Blower Door between inside and outside of the enclosure. This pressure is commonly measured by Channel A on the gauge.