

R6050SD

REED INSTRUMENTS

Data Logging Thermo- Hygrometer



Instruction Manual

Table of Contents

Introduction	3
Product Quality.....	3
Safety	4
Features.....	4
Included.....	4
Specifications	5-6
Instrument Display.....	7
Display Description	8
Operating Instructions.....	9-12
<i>Power ON/OFF</i>	9
<i>Selecting Measurement Modes</i>	9
<i>Humidity/Temperature Measurement Mode</i>	9
<i>Dew Point Measurement Mode</i>	10
<i>Wet Bulb Measurement Mode</i>	10
<i>Type K/J Thermocouple Measurement Mode</i>	11
<i>Data Hold</i>	11
<i>Recording Maximum and Minimum Readings</i>	11-12
<i>Backlight</i>	12
Setup Mode.....	12-15
<i>Setting the Time and Date (dAtE)</i>	13
<i>Setting Data Decimal Format (dEC)</i>	13
<i>Enabling/Disabling Auto Power Off (PoFF)</i>	13
<i>Enabling/Disabling the Beeper (bEEP)</i>	14
<i>Selecting Thermocouple Type (tYPE)</i>	14
<i>Selecting the Temperature Unit of Measure (t-CF)</i>	14
<i>Setting the Data Logging Sampling Rate (SP-t)</i>	14
<i>Formatting the SD Card (Sd F)</i>	15
<i>Verify Set Time and Date</i>	15
<i>Verify Sampling Rate</i>	15

continued...

Data Logging	15-17
<i>Data Recording Modes</i>	15
<i>Manual Data Logging Mode</i>	16
<i>Automatic Data Logging Mode</i>	16
<i>Transferring Data from the SD Memory Card to a Computer</i>	17
Humidity Calibration Procedure	18
Data Stream Output	18-19
<i>3.5mm Terminal to RS-232 Serial Connection</i>	19
System Reset	19
Battery Replacement.....	20
Applications.....	20
Accessories and Replacement Parts	20-21
FAQ's.....	21-22
Product Care	22
Product Warranty	23
Product Disposal and Recycling	23
Product Support.....	23

Introduction

Thank you for purchasing your REED R6050SD Data Logging Thermo-Hygrometer. Please read the following instructions carefully before using your instrument. By following the steps outlined in this manual your meter will provide years of reliable service.

Product Quality

This product has been manufactured in an ISO9001 facility and has been calibrated during the manufacturing process to meet the stated product specifications. If a certificate of calibration is required please contact the nearest authorized REED distributor or authorized Service Center. Please note an additional fee for this service will apply.

Safety

Never attempt to repair or modify your instrument. Dismantling your product, other than for the purpose of replacing batteries, may cause damage that will not be covered under the manufacturer's warranty. Servicing should only be provided by an authorized service center.

Features

- Measures relative humidity, ambient temperature and dew point/wet bulb temperatures
- Contact temperature measurement with a type J/K thermocouple option
- Temperature is measured in °C or °F
- Real time data logger with integrated SD memory card
- User selectable sampling rate from 1 to 3600 seconds
- Easy-to-read backlit LCD display
- Data hold and Min/Max functions
- Tripod mount for long-term monitoring
- Low battery indicator and auto shut off

Included

- Humidity/Temperature Probe
- Soft Carrying Case
- Batteries

Specifications

Temperature

Measuring Range:	32 to 122°F (0 to 50°C)
Accuracy:	±1.5°F (0.8°C)
Resolution:	0.1°F/°C

Contact Temperature (Probe sold separately)

Measuring Range:	Type K: -148 to 2372°F (-100 to 1300°C) Type J: -148 to 2192°F (-100 to 1200°C)
Accuracy:	≥-58°F (-50°C) ±(0.4% + 1°F (0.5°C)) ≤-58°F (-50°C) ±(0.4% + 1.8°F (1°C))
Resolution:	0.1°F/°C

Dew Point

Measuring Range:	-13.5 to 120.1°F (-25.5 to 48.9°C)
Accuracy:	Sum of temp and RH accuracy
Resolution:	0.1°F/°C

Wet Bulb

Measuring Range:	-6.9 to 122.0°F (-21.6 to 50.0°C)
Accuracy:	Sum of temp and RH accuracy
Resolution:	0.1°F/°C

Humidity

Measuring Range:	5 to 95% RH
Accuracy:	±(3% rdg. + 1% RH): ≥70% RH ±3% RH: < 70% RH
Resolution:	0.1% RH

continued...

REED

5

General Specifications

Display:	Dual Display, LCD
Backlit Display:	Yes
Data Hold:	Yes
Min:	Yes
Max:	Yes
Datalogging Capabilities:	Yes
Real-Time Clock and Date Stamp:	Yes
Sampling Rate:	Yes (1, 2, 5, 10, 30, 60, 120, 300, 600, 1800, 3600 seconds)
External Memory:	Yes, expandable up to 16GB with SD card (optional)
Auto Shut-off:	Yes (after 10 minutes/off)
Kick Stand:	Yes
Tripod Mountable:	Yes
Low Battery Indicator:	Yes
Power Supply:	6 x AA batteries or AC Adapter (optional)
Data Output:	Yes (RS-232)
Battery Life:	Sampling Time Dependent
Product Certifications:	CE
Operating Temperature:	32 to 122°F (0 to 50°C)
Storage Temperature:	14 to 140°F (-10 to 60°C)
Operating Humidity Range:	10 to 80%
Dimensions:	7 x 2.7 x 1.9" (177 x 68 x 45mm)
Weight:	1.13lbs (515g)

Instrument Description

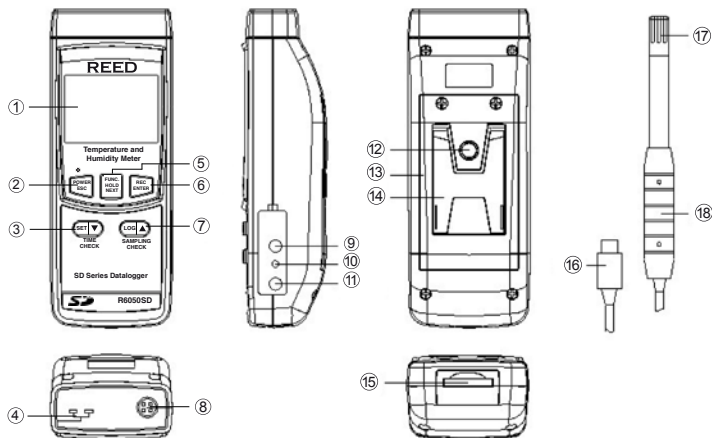

- | | |
|--|---|
| 1. LCD Display | 9. RS-232 Output Jack |
| 2. POWER/Backlight ESC Button | 10. Reset Pin |
| 3. SET/Down/TIME CHECK Button | 11. Power Adapter Input |
| 4. Type K/J Thermocouple Input Jack | 12. Tripod Mounting Screw |
| 5. FUNCTION/HOLD/NEXT Button | 13. Battery Cover |
| 6. REC/ENTER Button | 14. Kickstand |
| 7. LOG/Up/SAMPLING CHECK Button | 15. SD Card Slot |
| 8. Humidity/Temperature Probe Input Socket | 16. Humidity/Temperature Probe Plug |
| | 17. Humidity/Temperature Probe Sensing Head |
| | 18. Humidity/Temperature Probe Handle |

REED

Display Description

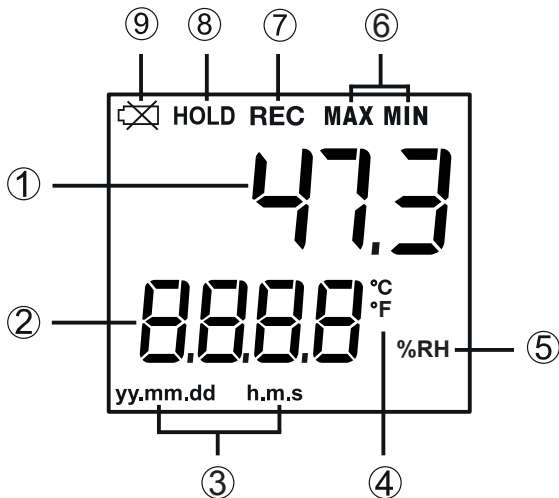

1. Relative Humidity/Dew Point/Wet Bulb/Type K/J Thermocouple Measurement Reading
2. Date & Time Values/Temperature Measurement Reading
3. Date/Time Stamp
4. Temperature Unit of Measure
5. Relative Humidity Unit of Measure
6. Maximum and Minimum Indicator
7. Record Mode Indicator
8. Data Hold Indicator
9. Low Battery Indicator

Operating Instructions

Power ON/OFF

1. Turn the meter on by pressing the **POWER** button. To turn the meter off, press and hold the **POWER** button for 2 seconds.

Note: This meter can be powered by either 6 x "AA" batteries or an AC adapter (sold separately).

Selecting Measurement Modes

The R6050SD offers 4 types of measurement modes:

- Humidity/Temperature
- Dew Point
- Wet Bulb
- Type K/J Thermometer

1. When the meter is on, press and hold the **FUNCTION** button to scroll through the measurement modes as indicated by "rH" (for Humidity/Temperature measurement), "dp" (for Dew Point measurement), "_Et" (for Wet Bulb measurement) and "tP" (for Type K/J Thermometer measurement.)
2. Release the **FUNCTION** button to confirm selection.

Humidity/Temperature Measurement Mode

1. While the meter is off, plug the Probe into the Probe Input Socket, then power on the meter by pressing the **POWER** button.
2. Select the "rH" function (see *Selecting Measurement Modes* for details).
3. Hold the Probe Handle and face the Probe Head against the measuring source. The top part of the display will indicate the humidity value, and the lower part of the display will indicate the temperature value as shown below.

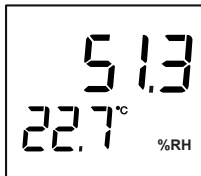

continued...

Dew Point Measurement Mode

1. Select the "dP" function (see *Selecting Measurement Modes* for details).
2. Hold the Probe Handle and face the Probe Head against the measuring source. The top part of the display will indicate the dew point value, and the lower part of the display will indicate "dP" as shown below.

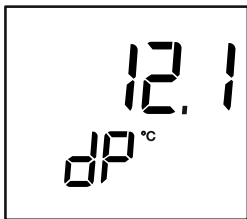

Wet Bulb Measurement Mode

1. Select the "_Et" function (see *Selecting Measurement Modes* for details).
2. Hold the Probe Handle and face the Probe Head against the measuring source. The top part of the display will indicate the wet bulb value, and the lower part of the display will indicate "_Et" as shown below.

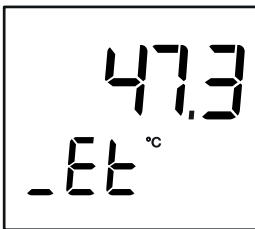

continued...

Type K/J Thermocouple Measurement Mode

1. Select the "tP" function (see *Selecting Measurement Modes* for details).
2. Plug the optional Type K or J Thermocouple Probe into the Type K/J thermocouple input jack.
3. The screen will display a "K", confirming that is configured by default to a Type K thermocouple probe. The measured temperature will now be displayed on the display screen as shown below.

Note: If using a type J thermocouple probe, see *Selecting Thermocouple Type* for details.

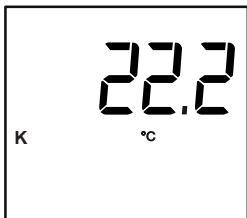

Data Hold

1. While taking a measurement, press the **HOLD** button to freeze the current measurement(s) on the display.
2. While in this mode a "HOLD" symbol will appear on the display.
3. Press the **HOLD** button again to resume normal operation.

Note: When the Data Hold feature is active all buttons except the **POWER** button are disabled.

Recording Maximum and Minimum Readings

1. Press the **REC** button to enter recording mode as indicated by "REC" on the LCD. The meter will now begin recording maximum and minimum readings.
2. While in recording mode;
 - A) Press the **REC** button once and the maximum value will appear on the display as indicated by "REC MAX".

continued...

- B) Press the **REC** button again and the minimum value will appear on the display as indicated by "REC MIN".
- C) To exit recording mode and resume normal operation, press and hold the **REC** button for two seconds.

When in recording mode the **POWER** button is disabled and the meter cannot be turned off.

Backlight

After powering the meter ON, the LCD Backlight will turn on automatically. Press the BACKLIGHT button to turn the LCD Backlight on or off.

Setup Mode

1. Press and hold the **SET** button for 2 seconds to enter Setup Mode.
2. Press the **NEXT** button continuously to scroll through the following parameters.

Parameter	Description
dAtE	Set the time and date
dEC	Set the decimal format (USA (20.00) or European (20,00))
PoFF	Enable or disable the auto-power off function
bEEP	Turn the beeper on or off
tYPE	Select thermocouple type (K or J)
t-CF	Select the temperature unit of measure (°C or °F)
SP-t	Set the data logging sampling rate
Sd F	Format the SD memory card

3. Once the appropriate parameter has been selected, follow the instructions below.

Note: The meter will automatically exit out of the Setup mode if no key is pressed within 7 seconds.

continued...

Setting the Time and Date (dAtE)

1. Press the **ENTER** button when "dAtE" appears on the LCD.
2. Press the **▲** and **▼** buttons to adjust the year as indicated by "YY".
3. Press the **ENTER** button to confirm selection.
4. Repeat steps 2 and 3 for month, day, hour, minute and seconds as indicated by (mm/dd/h/m/s).
5. After each value has been selected and confirmed, the meter will automatically skip to the next parameter.

Note: At any time, you can press the **ESC** button to exit the Setup mode and resume normal operation. The internal clock will keep accurate time when the meter is powered off. When new batteries are installed the clock will have to be reset.

Setting Data Decimal Format (dEC)

Numeric formats vary in different countries. By default the meter is set to bASIC mode where a decimal point is used to separate units, (i.e. 20.00). The European format uses a comma (i.e. 20,00) to separate units. To change this setting, follow steps 1 and 2 when "dEC" appears on the LCD.

1. Press the **▲** and **▼** buttons to select between bASIC and Euro.
2. Press the **ENTER** button to confirm selection and skip to next parameter.

Note: At any time, you can press the **ESC** button to exit the Setup mode and resume normal operation

Enabling/Disabling Auto Power Off (PoFF)

Follow steps 1 and 2 when "PoFF" appears on the LCD.

1. Press the **▲** and **▼** buttons to select between YES (enabled) or NO (disabled). With the Auto Power OFF feature enabled, the meter will automatically switch OFF after 10 minutes of inactivity to preserve battery life.
2. Press the **ENTER** button to confirm selection and skip to next parameter.

Note: At any time, you can press the **ESC** button to exit the Setup mode and resume normal operation.

continued...

Enabling/Disabling the Beeper (bEEP)

Follow steps 1 and 2 when "bEEP" appears on the LCD.

1. Press the ▲ and ▼ buttons to select between ON (enabled) or OFF (disabled).
2. Press the **ENTER** button to confirm selection and skip to next parameter.

Note: At any time, you can press the **ESC** button to exit the Setup mode and resume normal operation.

Selecting Thermocouple Type (tYPE)

Follow steps 1 and 2 when "tYPE" appears on the LCD.

1. Press the ▲ and ▼ buttons to select between type K and J.
2. Press the **ENTER** button to confirm selection and skip to next parameter.

Note: At any time, you can press the **ESC** button to exit the Setup mode and resume normal operation.

Selecting the Temperature Unit of Measure (t-CF)

Follow steps 1 and 2 when "t-CF" appears on the LCD.

1. Press the ▲ and ▼ buttons to select between °C and °F.
2. Press the **ENTER** button to confirm selection and skip to next parameter.

Note: At any time, you can press the **ESC** button to exit the Setup mode and resume normal operation.

Setting the Data Logging Sampling Rate (SP-t)

Follow steps 1 and 2 when "SP-t" appears on the LCD.

1. Press the ▲ and ▼ buttons to adjust the sampling rate between 0, 1, 2, 5, 10, 30, 60, 120, 300, 600, 1800, and 3600 seconds.
2. Press the **ENTER** button to confirm selection and skip to next parameter.

Note: At any time, you can press the **ESC** button to exit the Setup mode and resume normal operation.

continued...

Formatting the SD Card (Sd F)

Follow steps 1 through 5 when "Sd F" appears on the LCD.

1. Press the ▲ and ▼ buttons to select "YES" to format the card. Select "NO" to abort.
2. Press the **ENTER** button to confirm selection.
3. Press the **ENTER** button again to re-confirm.
4. The meter will format the SD card and automatically return to the Setup menu when formatting is complete.
5. Press the **ESC** button to exit the Setup mode and resume normal operation.

Note: It is recommended that new SD cards be formatted prior to first use. If the formatting process fails, the meter will display "-E-".

Verify Set Time and Date

During normal operation press the TIME CHECK button to display the year, month, day, hour and minutes.

Verify Sampling Rate

During normal operation, press the SAMPLING CHECK button to view the selected sampling rate.

Data Logging

Data Recording Modes

Manual Data Logging: Press the **LOG** button to manually log up to 99 readings on a SD memory card (see *Manual Data Logging Mode* for details).

Automatic Data Logging: Setup the meter parameters in order to automatically log data on a SD memory card. The number of data points is limited by the size of the memory card.

Note: It is recommended to use a class 4 SDHC memory card between 1 and 16Gb. Insert the SD memory card in the slot at the bottom of the meter. The card must be inserted with the label side facing the rear of the meter.

continued...

Manual Data Logging Mode

In manual mode, the **LOG** button is pressed to manually log a reading on the inserted SD card at any time. In order to setup the meter for manual data logging, follow steps 1 through 8 below.

1. Set the data logging sampling rate to "0" seconds (see *Setting the Data Logging Sampling Rate* section for details).
2. Press the **REC** button and "REC" will appear on the LCD.
3. The meter will also display P-X (X = memory position number between 1 and 99).
4. Press the **SET** button to enter the data memory positions selection.
5. Press the **▲** and **▼** buttons to select one of the 99 data memory positions in which to record.
6. Press the **ENTER** button to confirm selection.
7. Press the **LOG** button again to save a reading to memory. "REC" will flash each time a data point is stored.
8. To exit manual data logging mode, press and hold the **REC** button 2 seconds to resume normal operation.

Automatic Data Logging Mode

In automatic mode the desired data logging sampling rate is set to 1, 2, 5, 10, 30, 60, 120, 300, 600, 1800 or 3600 seconds prior to recording (see *Setting the Data Logging Sampling Rate* section for details). In order to setup the meter for automatic data logging, follow steps 1 through 5 below.

1. To begin a data logging session Press the **REC** button and "REC" will appear on the LCD.
2. Press the **LOG** button. The meter will scan for a SD memory card. If a card is not inserted or the card is defective, the meter will flash "CARd -E-" indefinitely. In this case, power the meter OFF and try again with another SD memory card.
3. The "REC" icon will appear on the LCD and will continuously flash while in a data logging session.
4. To pause the data logging session press the **LOG** button and "REC" will stop flashing. To resume press the **LOG** button again.
5. To end the current data logging session pause the data logging session and hold the **REC** button until "REC" disappears.

continued...

Transferring Data from the SD Memory Card to a Computer

1. While the meter is powered Off remove the SD memory card from the SD card slot.
2. Insert the SD memory card into the computer.
3. Open the file(s) with Excel. See sample below:

Place	Date	Time	Value	Unit	Value	Unit
1	19-07-10	1:13:10	18.4	%RH	22.6	Degree C
2	19-07-10	1:13:12	30	%RH	25	Degree C
3	19-07-10	1:13:14	25	%RH	35	Degree C
4	19-07-10	1:13:16	45	%RH	30	Degree C
5	19-07-10	1:13:18	30	%RH	35	Degree C
6	19-07-10	1:13:20	45	%RH	25	Degree C
7	19-07-10	1:13:22	50	%RH	35	Degree C
8	19-07-10	1:13:24	60	%RH	30	Degree C
9	19-07-10	1:13:26	45	%RH	28	Degree C
10	19-07-10	1:13:28	30	%RH	22.6	Degree C
11	19-07-10	1:13:30	17.5	%RH	22.6	Degree C
12	19-07-10	1:13:32	17.5	%RH	22.6	Degree C

The raw data can be used to create a graph in Excel. See sample below:

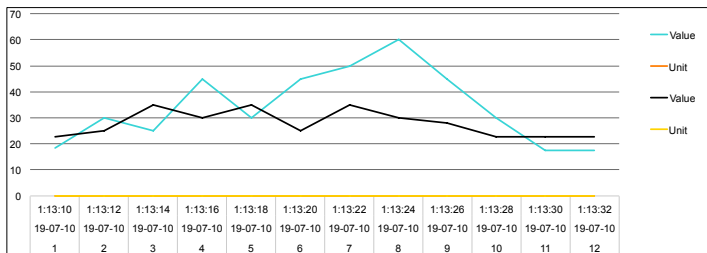

Humidity Calibration Procedure

In order to calibrate the meter humidity calibration standards are required (REED R9933, R9975 or R9980). If the meter has been exposed to extreme conditions or it has not been used in a long period of time the meter should be calibrated by following steps 1 through 5 below.

1. While in normal %RH measurement mode, hold the **SET** and **LOG** buttons simultaneously for approx. 2 seconds to enter the calibration mode of %RH.
2. The LCD display will show the same relative humidity measuring value along with the %RH symbol.
3. Press the ▲ and ▼ buttons to adjust the upper display until it matches the %RH Humidity Calibration Standard.
4. Once the calibration is complete, press "REC" button to save the calibration value into the memory which will flash confirming it has been saved.
5. Press the **NEXT** button twice to exit the calibration mode and resume normal operation.

Note: At any time, you can press the **ESC** button to exit the calibration mode and resume normal operation.

Data Stream Output

Using Terminal application, a data stream can be viewed from the RS-232 output, connect RS-232/USB cable between the product and terminal/PC and use the following setting to view the data stream.

Terminal Settings:

- Bits per second: 9600
- Data bits: 8
- Parity: None
- Stop bits: 1

continued...

4101010000501, = Upper Value, +50.1% RH

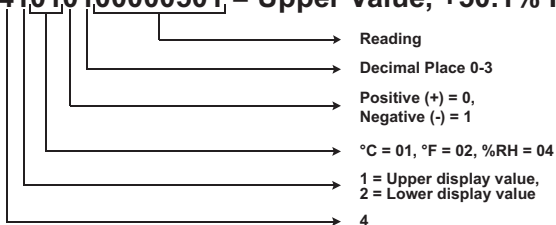

3.5mm Terminal to RS-232 Serial Connection

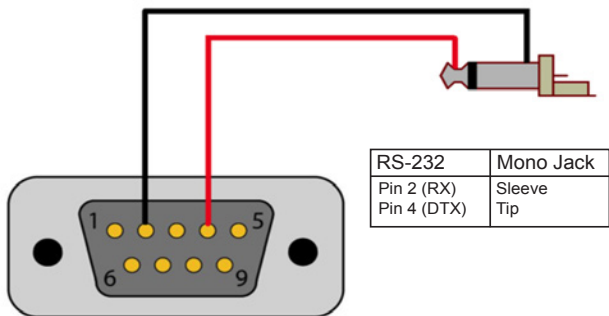

System Reset

If the meter becomes unresponsive or if the display freezes the Reset pin can be used to reset the instrument.

1. Use a paper clip or any similar small object to press the Reset pin.
2. After pressing the Reset pin, power the meter back up by holding the **POWER** button for 2 seconds.
3. If resetting the meter does not resolve the issue, please return the meter to the nearest authorized REED distributor or authorized Service Center for repair.

Battery Replacement

When the low battery icon  appears on the LCD, the batteries must be replaced.

1. Remove the two (2) Phillips screws on the back of the meter directly located above the top of the kickstand.
2. Remove the battery cover.
3. Replace 6 x "AA" batteries.
4. Secure the battery cover with the two (2) Phillips screws.

Applications

- Environmental studies
- Food distribution
- HVAC/R system installation
- Greenhouses and industrial spaces
- Saunas
- Humidors
- Museums
- Lab Monitoring

Accessories and Replacement Parts

R9933 Humidity Standard, 33%

R9975 Humidity Standard, 75%

R9980 Humidity Standard, 33% and 75%

R6050SD-PROBE Replacement Probe for R6050SD

R2920 Surface Thermocouple Probe

R2930 Right Angle Thermocouple Probe

R2940 Air/Gas Thermocouple Probe

R2950 Immersion Thermocouple Probe

R2960 Needle Tip Thermocouple Probe

TP-01 Beaded Thermocouple

continued...

REED

20

R1500 Tripod

RSD-ADP-NA Power Supply, 110V

RSD-ADP-EU Power Supply, 220V

CA-05A Soft Carrying Case

R8888 Deluxe Hard Carrying Case

SD-4GB 4GB Class 4 SDHC Memory Card

RSD-16GB 16GB Micro SD Memory Card w/ Adapter

Don't see your part listed here? For a complete list of all accessories and replacement parts visit your product page on www.REEDInstruments.com.

Frequently Asked Questions (FAQ's)

I cannot turn off my meter, do you know why?

Often times, the meter cannot be turned off because it is in recording mode ("REC" mode). Make sure to exit that function by holding down the **REC** button before attempting to turn the meter off.

How long can I record for?

Battery life will depend on a number of factors:

- Quality of Battery
- Whether the beeper is ON or OFF
- Whether the backlight is ON or OFF
- Environmental Conditions during data logging

As a reference, using alkaline batteries with both the backlight and beeper on while automatic data logging at a 2 second sampling rate; the batteries will last approximately 14 hours.

Is there any way to make the R6050SD record temp, humidity, dew point, wet bulb, and Type K readings all at the same time?

The R6050SD is unable to measure all the parameters simultaneously.

continued...

If the screen displays the "_ET" function, will it still record humidity/temperature? How do I select the "rH" function to display on the screen. I want to record the humidity/temperature for an extended period of time.

The R6050SD offers 4 types of measurement modes:

1. Humidity/ Temp
2. Dew Point
3. Wet Bulb
4. Type K/J Thermometer

When the meter is on, press and hold the FUNCTION button to scroll through the measuring modes. The display will flash "rH", for Humidity/ Temperature measurement, "dP" for Dew Point measurement, "_Et" for Wet Bulb measurement, and "tP" for Type K/J Thermometer measurement. Release the FUNCTION button to confirm selection. Select the "rH" option for extended recording of temperature and humidity.

Product Care

To keep your instrument in good working order we recommend the following:

- Store your product in a clean, dry place.
- Change the battery as needed.
- If your instrument isn't being used for a period of one month or longer please remove the battery.
- Clean your product and accessories with biodegradable cleaner. Do not spray the cleaner directly on the instrument. Use on external parts only.

Product Warranty

REED Instruments guarantees this instrument to be free of defects in material or workmanship for a period of one (1) year from date of shipment. During the warranty period, REED Instruments will repair or replace, at no charge, products or parts of a product that proves to be defective because of improper material or workmanship, under normal use and maintenance. REED Instruments total liability is limited to repair or replacement of the product. REED Instruments shall not be liable for damages to goods, property, or persons due to improper use or through attempts to utilize the instrument under conditions which exceed the designed capabilities. In order to begin the warranty service process, please contact us by phone at 1-877-849-2127 or by email at info@REEDInstruments.com to discuss the claim and determine the appropriate steps to process the warranty.

Product Disposal and Recycling



Please follow local laws and regulations when disposing or recycling your instrument. Your product contains electronic components and must be disposed of separately from standard waste products.

Product Support

If you have any questions on your product, please contact your authorized REED distributor or REED Instruments Customer Service by phone at 1-877-849-2127 or by email at info@REEDInstruments.com.

Please visit www.REEDInstruments.com for the most up-to-date manuals, datasheets, product guides and software.

*Product specifications subject to change without notice.
All rights reserved. Any unauthorized copying or reproduction of this manual is strictly prohibited without prior written permission from REED Instruments.*

REED INSTRUMENTS

TEST & MEASURE WITH CONFIDENCE



Access our
Product Catalog

Over 200 portable test and
measurement instruments

