

# PosiTector® 6000 Series

Coating Thickness Gages for **ALL** Metal Substrates



*Includes protective rubber holster*



**3 Powerful Scan Modes**

**180+ readings/minute**

*Advanced models only*

**DeFelsko®**  
The Measure of Quality



Available on the  
App Store



PosiTector®  
SmartLink  
Compatible



Find Quality Products Online at:

[www.GlobalTestSupply.com](http://www.GlobalTestSupply.com)

[sales@GlobalTestSupply.com](mailto:sales@GlobalTestSupply.com)

# PosiTector® 6000 Series

## All Gages Feature...

### Simple

- Fast measurement speed—60+ readings per minute. Enhanced FAST mode—90+ readings per minute for quick inspection.
- Ready to measure—no adjustment required for most applications
- **NEW** Larger 2.8" impact resistant color touchscreen with redesigned keypad for quick menu navigation
- **NEW** On-gage help explains menu items at the touch of a button
- Flashing display—ideal in a noisy environment
- RESET feature instantly restores factory settings

### Durable

- **NEW** Weatherproof, dustproof, and water-resistant—IP65-rated enclosure
- **NEW** Ergonomic design with durable rubberized grip
- Wear-resistant probe tip
- Shock-absorbing protective rubber holster for added impact resistance
- Two year warranty on gage body AND probe

### Accurate

- Certificate of Calibration showing traceability to NIST or PTB included
- Built-in temperature compensation ensures measurement accuracy
- Hi-RES mode increases displayed resolution for precision applications
- Conforms to national and international standards including ISO and ASTM

### Versatile

- PosiTector body accepts all PosiTector 6000, 200, DPM, IRT, RTR, SPG, SST, SHD, BHI, and UTG probes easily converting from a coating thickness gage to a dew point meter, surface profile gage, soluble salt tester, hardness tester, or ultrasonic wall thickness gage
- Multiple calibration adjustment options including zero, 1-point, 2-point, and ISO 19840 correction factors
- Selectable display languages
- **NEW** Auto rotating display with Flip Lock
- Extended cables available (up to 75 m/250 ft) for remote measuring

### Powerful

- Continually displays/updates average, standard deviation, min/max, and number of readings while measuring
- **NEW** Screen Capture—save 100 screen images for record keeping and review
- HiLo alarm audibly and visibly alerts when measurements exceed user-specified limits
- **NEW** Instant-on feature quickly powers up the gage if recently powered down
- **NEW** Up to 30% longer battery life
- USB port for fast, simple connection to a PC and to supply continuous power. USB cable included.
- PosiSoft USB Drive—stored readings and graphs can be accessed using universal PC/Mac web browsers or file explorers. No software required.
- Every stored measurement is date and time stamped
- Includes PosiSoft suite of software for viewing and reporting data (see far right)

### Probes available for a variety of applications



For measuring paint, powder, etc.  
on all metals

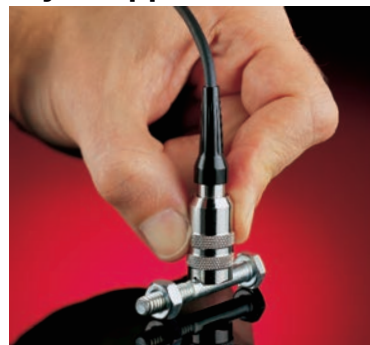

...and for measuring galvanizing, plating,  
anodizing and more

### Standard Models

**Includes ALL features as shown on left plus...**

- **NEW** Storage of 1,000 readings per probe—stored readings can be viewed or downloaded

### Advanced Models

**Includes ALL features as shown on left plus...**

- **NEW** Storage of 250,000 readings from multiple probes in up to 1,000 batches and sub-batches
- Live graphing of measurement data
- **NEW** Prompted Batch Mode—create pre-defined batches with on-screen text and image prompts for each reading (see far right)
- **3 Scan Modes**—increase measurement speed to 180+ readings per minute
  - **Normal** – take continuous readings without lifting the probe
  - **Statistics** – take continuous readings and record average, standard deviation, min/max thickness and number of readings while scanning
  - **Limited Count Average** – take continuous readings up to a user-specified count. The gage displays and records the average of the readings.
- **NEW** Touchscreen keyboard for quickly renaming batches, adding notes, and more
- Multiple stored calibration adjustments for measuring on a variety of substrate conditions
- **NEW** SSPC-PA 2, ISO 19840, and IMO PSPC 90:10 modes help users comply with standards by prompting for max/min specifications, displaying the necessary readings, and automatically calculating statistics with a pass/fail result
- WiFi technology wirelessly synchronizes with PosiSoft.net and downloads software updates
- **Bluetooth 4.0 Technology** for data transfer to a mobile device running the PosiTector App or optional portable printer. **BLE API** available for integration into third-party software.

### PosiTector SmartLink™

- Wirelessly connect PosiTector 6000 probes to your smart device

**Select from a variety of measurement ranges and probe styles**

(see ordering guide on back page)



Removable Probes can be detached and replaced with any one of our wide variety of probes



# Rugged Features...

Sealed USB Port for communicating with a PC or Mac

Weatherproof, dustproof, and shockproof



2.8" impact resistant color touchscreen display

Auto rotating display with Flip Lock and on-screen help

Ergonomic design with durable rubberized grip

Redesigned keypad for quick navigation

Sealed connector protects probe from water and dust intrusion

Quality high-flex cable and strain relief

Stainless steel probe with knurled finger grip

Strong wear-resistant ruby-tipped probe



**Advanced Model shown with Prompted Batch Mode enabled**



**All Regular Cabled Probes are suitable for underwater use**

# PosiSoft... FREE SOLUTIONS for viewing, analyzing and reporting data:



### PosiSoft Desktop

Powerful desktop software for downloading, viewing, printing, and storing measurement data. Includes customizable, templated PDF Report Generator. No internet connection required.

### NEW Prompted Batch Mode

Create pre-defined batches with onscreen text and image prompts for each reading and upload to PosiTector 6000 Advanced models only. Ideal for ensuring a consistent measurement pattern for repetitive jobs.

### PosiSoft.net

A web-based application offering secure centralized management of readings. Includes customizable, templated PDF Report Generator. Access your data from any web-connected device.



### PosiTector App

Mobile app connects PosiTector Advanced instruments, the PosiTector SmartLink and the PosiTest AT-A to your iOS or Android smart device.



### PosiSoft USB Drive

A simple gage interface to retrieve data in a manner similar to USB flash drives, cameras, or digital audio players. No software to install or internet connection required.

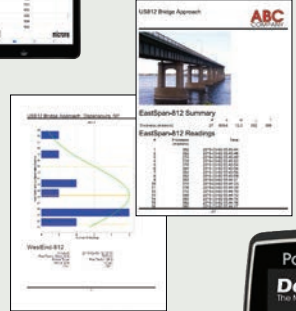

### Award Winning Compatibility!

- Coating Thickness
- Surface Profile
- Environmental Conditions
- Hardness
- Salt Contamination
- Ultrasonic Wall Thickness

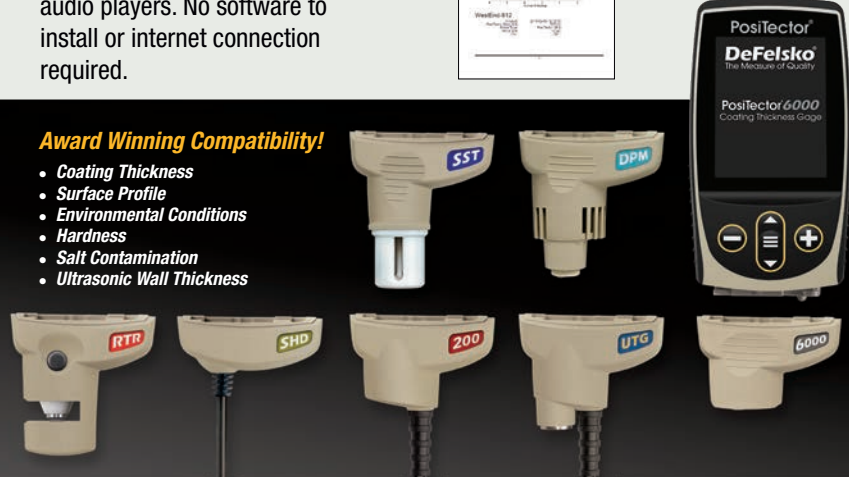

**Duplex Probe** measures individual layer thicknesses of zinc and paint in a duplex coating system



**Xtreme Probes** with Alumina wear faces and braided cables for hot/rough surfaces



**Thick Probe** series for thick protective coatings: epoxy, rubber, fireproofing, and



**Microprobe** series for small parts and hard-to-reach areas

Find Quality Products Online at:

[www.GlobalTestSupply.com](http://www.GlobalTestSupply.com)

[sales@GlobalTestSupply.com](mailto:sales@GlobalTestSupply.com)

		Our most popular Integral and Cabled probe models				90° Regular probe for tight spots	Ideal for duplex coating systems	Ideal for hot and rugged applications	Ideal for anodized aluminum	Microprobes – Our smallest probes for small parts or hard-to-reach areas				Integral and Cabled probes for thick protective coatings; epoxy, rubber, intumescent fireproofing and more						
FERROUS	Standard	F1	FS1	FRS1				FXS1 <sup>1</sup>		FOS1	F45S1	F90S1	F90ES1	FT1	FTS1	FTRS1	FHXS1 <sup>1,2</sup>	FKS1	FJS1	FLS1
	Advanced	F3	FS3	FRS3				FXS3 <sup>1</sup>		FOS3	F45S3	F90S3	F90ES3	FT3	FTS3	FTRS3	FHXS3 <sup>1,2</sup>	FKS3	FJS3	FLS3
NON-FERROUS	Standard	N1	NS1	NRS1					NAS1	NOS1	N45S1	N90S1						NKS1		
	Advanced	N3	NS3	NRS3					NAS3	NOS3	N45S3	N90S3						NKS3		
COMBINATION	Standard	FN1	FNS1	FNRS1	FNDS1 <sup>3</sup>										FNTS1					FNGS1 <sup>4</sup>
	Advanced	FN3	FNS3	FNRS3	FNDS3 <sup>3</sup>										FNTS3					FNGS3 <sup>4</sup>
Range		0–60 mils 0–1500 µm				0–80 mils 0–2000 µm	Ferrous: 0–45 mils and 0–1150 µm Non-Ferrous: 0–25 mils and 0–625 µm				0–250 mils 0–6 mm		0–400 mils 0–10,000 µm	0–500 mils 0–13 mm	0–1.0 in. 0–25 mm	0–1.5 in. 0–38 mm	0–2.5 in. 0–63.5 mm			
Accuracy <sup>5</sup>		±(0.05 mil + 1%) 0-2 mils ±(0.1 mil + 1%) >2 mils ±(1 µm + 1%) 0-50 µm ±(2 µm + 1%) >50 µm					±(0.02 mil + 1%) 0-4 mils ±(0.1 mil + 3%) >4 mils ±(0.5 µm + 1%) 0-100 µm ±(2 µm + 3%) >100 µm				±(0.5 mil + 1%) 0-100 mils ±(0.5 mil + 3%) >100 mils ±(0.01 mm + 1%) 0-2.5 mm ±(0.01 mm + 3%) >2.5 mm		±(0.1 mil + 3%)	±(1 mil + 3%)	±(0.01 in. + 3%) ±(0.2 mm + 3%)					
Matching DeFelsko Calibration Standards		STDS1 STDA1				STDS4	STDS2 STDA2				STDP1		STDP7	STDP5	STDP2	STDP8				

**Ferrous probes** measure non-magnetic coatings on ferrous metals. **Non-Ferrous probes** measure non-conductive coatings on non-ferrous metals. 1) **FXS/FHXS Xtreme probe series** with Alumina wear face and braided cable — ideal for rough or hot surfaces up to 250° C (500° F). 2) **FHXS probe** measures non-conductive coatings on steel only. 3) See website for full **FNDS probe** accuracy information. 4) **FNGS probe** measures non-conductive coatings on all metals. 5) Accuracies are stated as a fixed value plus a percentage of the gage's actual reading.

### Probe Details (All probe details can be found online at [www.defelsko.com/p6000/probes](http://www.defelsko.com/p6000/probes))

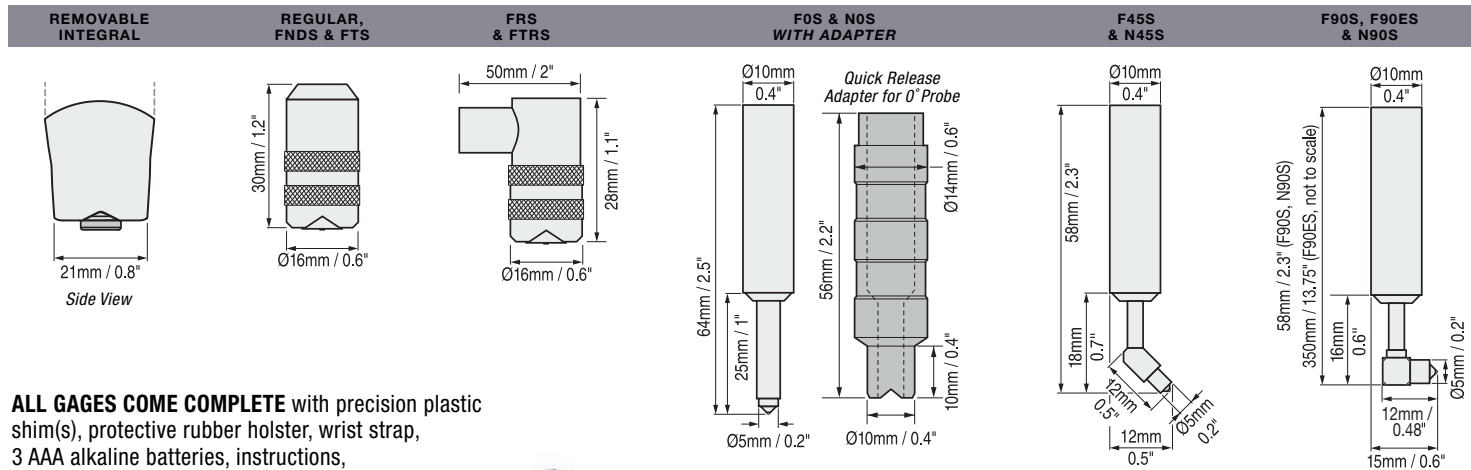

**ALL GAGES COME COMPLETE** with precision plastic shim(s), protective rubber holster, wrist strap, 3 AAA alkaline batteries, instructions, protective lens shield, convenient carrying case, Long Form Certificate of Calibration traceable to NIST or PTB, USB cable, PosiSoft Software, two (2) year warranty.

**\*SIZE:** 127 x 66 x 25.4 mm (5" x 2.6" x 1")

**\*WEIGHT:** 137 g (4.9 oz.) without batteries

\* Size and weight are for the PosiTector gage body only and do not include the probe.

Conforms to ISO 19840/2178/2360/2808, ASTM B244/B499/D1186/ D1400/D7091/E376/G12, BS3900-C5, SSPC-PA2 and others



### Options

**Coating Thickness Standards** to fulfill both ISO and in-house quality control requirements

**Probe Foot Rings** Durable Delrin ring allows the probe to slide easily while scanning

**Telescopic Probe Extender** for use with the PosiTector 6000 FS, NS, FNS, FXS, FNDS, NAS and FTS probes.  
 ■ Provides up to 124 cm (49") of reach and collapses to 47 cm (18.5") for easy storage

For a complete list of product features and available options visit [www.defelsko.com](http://www.defelsko.com)



# PosiSoft® Suite of Software

Powerful ways to view and report your PosiTector and PosiTest data

## PosiSoft Desktop — PC/Mac

Powerful desktop software for downloading, archiving, and reporting measurement data.

- Import readings directly from the gage via USB, WiFi, or legacy PosiSoft Desktop versions
- **Jobs feature** consolidates batches into groups to keep measurement data organized and to quickly create multi-batch reports
- Fully integrates with PosiSoft.net—backup and synchronize jobs, batches, readings, and report templates to the cloud (see inset at right)
- Export readings as .csv (comma separated value) files for easy import into Excel and other spreadsheets

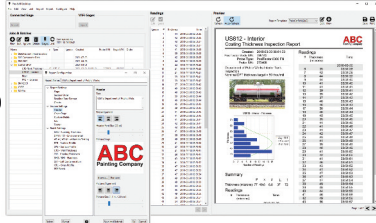

## Professional, Custom Reports

- Compile single or multi-batch reports from multiple probes and instrument types
- Add pictures, screen captures, notes, and more with an onscreen live preview
- Instantly create professional reports from pre-formatted report templates
- Design custom layouts and templates—add custom cover pages and logos, and choose to display charts, histograms, and/or individual readings
- Drag-and-drop Custom Fields mode—import PDF forms and overlay fields to automatically populate inspection data

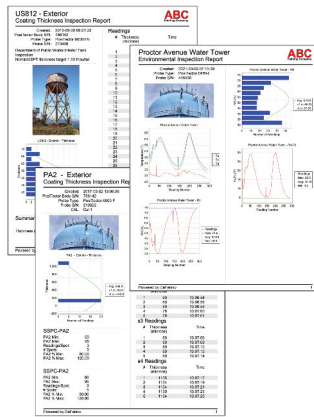

## Prompted Batch Mode

Create pre-defined batches with onscreen text and image prompts for each reading and upload to PosiTector 6000, 200, and UTG gages (*Advanced models only*).

- Ideal for ensuring a consistent measurement pattern for repetitive jobs or when specific measurement locations are required

## PosiSoft USB Drive — Gage based

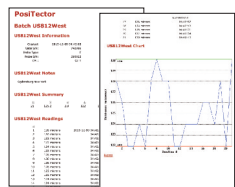

A simple gage interface to retrieve data in a manner similar to USB flash drives or cameras. No software to install or internet connection required. Measurement data can be printed quickly from a formatted HTML report or exported in .csv format for further analysis in spreadsheets.

## PosiTector App — iOS/Android

Fully-featured mobile app that connects to the PosiTector SmartLink, PosiTector Advanced gages, and the PosiTest AT-A.

- Auto pairing Bluetooth BLE connection
- Add images and notes to individual readings or batches directly from your device
- Email readings as .csv (comma separated value) files for easy import to Excel and other spreadsheets.
- Synchronize readings with PosiSoft.net—backup and synchronize jobs, batches, and readings to the cloud (see inset below)



## Mobile Reporting Solution

- Compile single or multi-batch reports from multiple probes and instrument types
- Add pictures, screen captures, notes, and more
- Email pre-formatted or custom reports from your device instantly

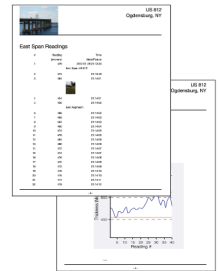

## PosiSoft.net

Secure storage of measurement data in the cloud.

compatible with PosiSoft Desktop and PosiTector App

- Upload measurement data directly from WiFi-connected PosiTector Advanced gages from anywhere in the world—no software required
- Synchronize and share measurement data across multiple computers

Ideal for...

- Users with multiple computers, instruments, and office locations
- Inspection companies managing data from multiple inspectors
- Login from PosiSoft Desktop to synchronize all measurement data and stored report templates from your account

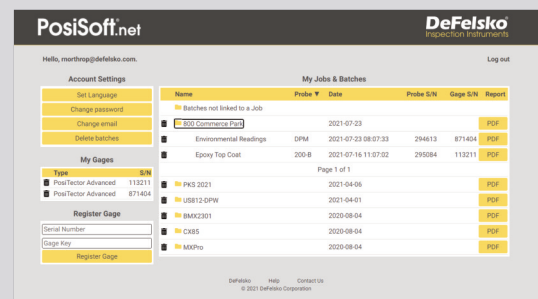

**PosiSoft.net Web Viewer** Review measurement data and print simple, pre-formatted PDF reports from any web browser—no software installation required.

## PosiTector Developer Resources

- Bluetooth 4.0
- WiFi
- Keyboard Mode
- USB Serial

PosiTector and PosiTest AT-A instruments can integrate with third-party software, drones, ROVs, PLCs, and robotic devices using several industry-standard communication protocols including: Bluetooth 4.0, WiFi, Keyboard mode, and USB serial.



© DeFelsko Corporation USA 2021. All Rights Reserved. Technical Data subject to change without notice. • Printed in USA • PSoft.v.LW/W2110

**DeFelsko®**

Made in U.S.A.

Find Quality Products Online at:

[www.GlobalTestSupply.com](http://www.GlobalTestSupply.com)

[sales@GlobalTestSupply.com](mailto:sales@GlobalTestSupply.com)