

INSTRUCTION MANUAL

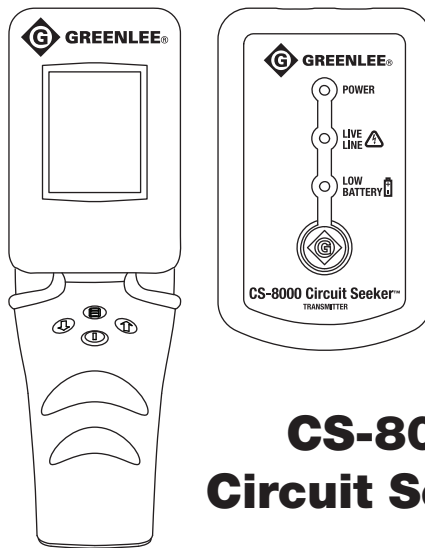

CS-8000 Circuit Seeker™

Circuit Tracer

Read and understand all of the instructions and safety information in this manual before operating or servicing this tool.





Description

The Greenlee CS-8000 Circuit Seeker™ Circuit Tracer identifies and traces either live or unenergized circuits. It also locates faults or opens in a circuit, identifies specific circuit breakers, and traces circuits including those shorted to ground. The CS-8000 consists of a receiver, a transmitter, and accessories for connecting the transmitter to the circuit being traced or identified.

The CS-8000 receiver incorporates patented, non-directional signal detection circuitry. It is not necessary to rotate the receiver when following the path of the traced object.

Safety

Safety is essential in the use and maintenance of Greenlee tools and equipment. This instruction manual and any markings on the tool provide information for avoiding hazards and unsafe practices related to the use of this tool. Observe all of the safety information provided.

Purpose of This Manual

This instruction manual is intended to familiarize all personnel with the safe operation and maintenance procedures for the Greenlee CS-8000.

Keep this manual available to all personnel.



Do not discard this product or throw away!

Lifetime Limited Warranty

Greenlee Textron Inc. warrants to the original purchaser of these goods for use that these products will be free from defects in workmanship and material for their useful life, excepting normal wear and abuse. This warranty is subject to the same terms and conditions contained in Greenlee Textron Inc.'s standard one-year limited warranty.

For items not covered under warranty (such as items dropped, abused, etc.), a repair cost quote is available upon request.

Note: Prior to returning any test instrument, please check replaceable batteries or make sure the battery is at full charge.

All specifications are nominal and may change as design improvements occur. Greenlee Textron Inc. shall not be liable for damages resulting from misapplication or misuse of its products.

® Registered: The color green for electrical test instruments is a registered trademark of Greenlee Textron Inc.

Circuit Seeker is a trademark of Greenlee Textron Inc.

KEEP THIS MANUAL

Important Safety Information



SAFETY ALERT SYMBOL

This symbol is used to call your attention to hazards or unsafe practices which could result in an injury or property damage. The signal word, defined below, indicates the severity of the hazard. The message after the signal word provides information for preventing or avoiding the hazard.

DANGER

Immediate hazards which, if not avoided, **WILL** result in severe injury or death.

WARNING

Hazards which, if not avoided, **COULD** result in severe injury or death.

CAUTION

Hazards or unsafe practices which, if not avoided, **MAY** result in injury or property damage.



WARNING

Read and understand this material before operating or servicing this equipment. Failure to understand how to safely operate this tool could result in an accident causing serious injury or death.



WARNING

Electric shock hazard:
Contact with live circuits could result in severe injury or death.

Important Safety Information

WARNING

Electric shock and fire hazard:

- Do not expose this unit to rain or moisture.
- Do not use the unit if it is wet or damaged.
- Use test leads or accessories that are appropriate for the application. Refer to the category and voltage rating of the test lead or accessory.
- Inspect the test leads or accessory before use. They must be clean and dry, and the insulation must be in good condition.
- Use this unit for the manufacturer's intended purpose only, as described in this manual. Any other use can impair the protection provided by the unit.

Failure to observe these warnings could result in severe injury or death.

WARNING

Electric shock hazard:

- The transmitter Live Line indication does not function if the batteries are dead or removed. Test on a known live circuit before use.
- Do not apply more than the rated voltage between any two input terminals, or between any input terminal and earth ground.
- Do not contact the test lead tips or any uninsulated portion of the accessory.
- Using this unit near equipment that generates electromagnetic interference can result in unstable or inaccurate readings.

Failure to observe these warnings could result in severe injury or death.

WARNING

Electric shock hazard:

- Do not operate with the case or battery compartment open.
- Before opening the case or battery compartment, remove the test leads from the circuit and shut off the unit.

Failure to observe these warnings could result in severe injury or death.

CAUTION

Electric shock hazard:

- Do not attempt to repair this unit. It contains no user-serviceable parts.
- Do not expose the unit to extremes in temperature or high humidity. Refer to "Specifications."

Failure to observe these precautions may result in injury and can damage the unit.

Identification

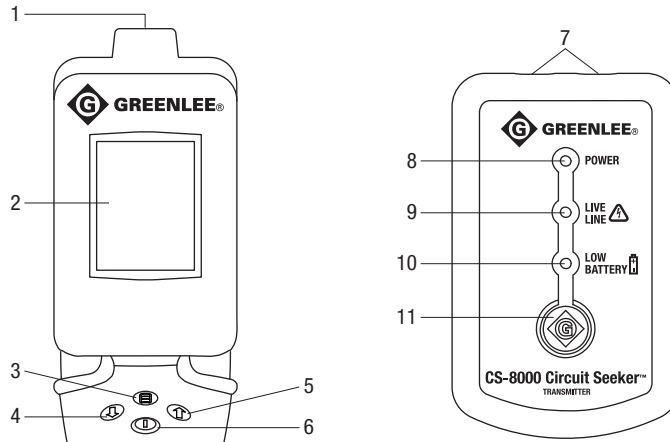

Receiver

- 1. Sensing surface
- 2. Display
- 3. Mode Selector
- 4. Decrease Manual Gain
- 5. Increase Manual Gain
- 6. Power/Signal Reset pushbutton

Transmitter

- 7. Connectors (non-polarized)
- 8. Power LED
- 9. Live Line LED
- 10. Low Battery LED
- 11. Power pushbutton

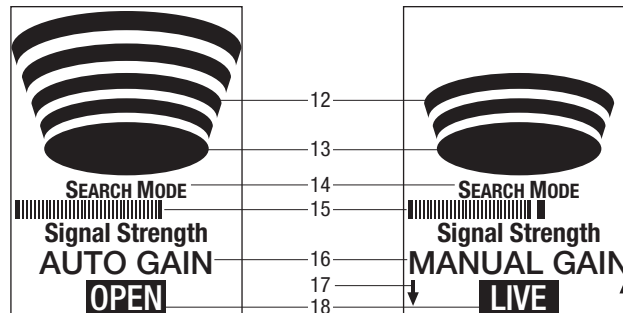

Display Icons

- 12. Relative Signal Strength
- 13. Transmitter Signal Indicator
- 14. Mode (Breaker–Search)
- 15. Absolute Signal Strength
- 16. Gain Mode (Auto–Manual)
- 17. Signal adjustment arrows (Manual Gain only)
- 18. Line Status (Live–Open)

Symbols on the Unit

- ⚠ Warning—Read the instruction manual
- ☐ Double insulation



Using the Features

Features of the Transmitter

Power Button: Press and release to turn the transmitter on. Press and release to turn the transmitter off.

Power LED: Indicates that the transmitter is turned on.

Live Line LED: This LED illuminates when the transmitter is connected to a voltage of at least 12 VAC or 5 VDC.

Low Battery LED: This LED illuminates when approximately one hour of battery life is remaining under typical use conditions. When this LED flashes, the batteries are nearly exhausted. Replace them immediately.

Automatic Power Off: The transmitter will turn off after four hours.

Features of the Receiver

The receiver is designed to be held in the user's hand. The hand and body act as a ground plane reference, which improves the sensitivity of the receiver. Without this ground plane reference, the range of the receiver can be significantly reduced.

Transmitter Signal Indicator: This indicator is a solid blue oval when the receiver senses the signal from the transmitter. Alternating segments of a red oval indicate there is no signal from the transmitter, or the signal is too low to detect at the current gain setting.

Absolute Signal Strength bar graph: This displays the strength of the received signal. The red bar indicates the maximum signal received since the unit was reset.

Relative Signal Strength indicators: These four arcs represent a magnified view of the Absolute Signal Strength bar graph. All four arcs will be displayed when the signal is approximately equal to the maximum signal received. Lower signal levels will display fewer arcs. When the signal drops further, no arcs will be displayed. The magnification factors are different in Breaker Mode and Search Mode, as explained below.

Gain Mode is Auto when the receiver is turned on. Manual Gain is selected by pressing either the Increase Manual Gain ↑ or Decrease Manual Gain ↓ button on the receiver. Refer to the "Using Gain Modes" section below for details of these modes.

Line Status is LIVE when the transmitter is connected to a circuit powered by at least 12 VAC or 5 VDC. Line Status is OPEN when the transmitter is connected to a deenergized line.

Power Button: Press and release to turn the receiver on. Press and hold to turn the receiver off.

This button also serves as **Signal Reset**. Press momentarily to reset the receiver gain to maximum. To change from Manual Gain to Auto Gain, press and hold for about one second, and then release. "AUTO GAIN" will appear on the display.

Mode Selector button toggles the receiver between Breaker Mode and Search Mode. The receiver is in Breaker Mode when it is initially powered on.

In Breaker Mode, weaker signals are ignored. A higher magnification factor is used for the Relative Signal Strength portion of the display. A smaller signal range is required to change the display from one arc to four arcs. Small changes in signal strength can be easily observed. This mode is usually best for identifying circuit breakers. It can also be useful for tracing circuits or objects that are very close to the receiver, and for locating the exact location of a break or short in a conductor.

In Search Mode, a wider range of signal strength is displayed. A lower magnification factor is used for the Relative Signal Strength portion of the display. A larger signal range is required to change the display from one arc to four arcs. This mode is usually best for locating and tracing circuits, except when the traced object is very close to the receiver.

Using the Features (cont'd)

There is overlap between the gain ranges of the Breaker Mode and Search Mode. The recommended mode usually gives the desired results. Some applications may be found where the alternate mode is preferred.

Using Gain Modes

Automatic Gain is the default mode for the CS-8000 receiver. The receiver gain is initially set to maximum. When the transmitter signal is detected, the gain is automatically decreased in proportion to the signal strength. At the reduced gain, the largest detected signal does not result in an overrange display. The detected signal is constantly monitored, and the gain is reduced further if a stronger signal is detected. Gain is never increased in the Auto Gain mode. The actual signal strength will decrease when tracing long conductors, or when the distance between the receiver and conductor is increased. It is possible to lose the signal if the receiver is moved too far from the actual path of the conductor. In these cases, momentarily press the **Power/Signal Reset** button to return the gain to maximum. This will restore maximum signal strength on the display and allow location of the true path of the conductor. This step may be repeated several times when tracing a circuit.

Manual Gain is useful when the gain must be held constant, such as when making comparisons between the signals on two different circuit breakers. It can also be used while tracing. Varying signal strength sometimes requires frequent resetting of the Auto Gain, which can be inconvenient.

To switch from Auto Gain to Manual Gain, press either the Increase Manual Gain ↑ or Decrease Manual Gain ↓ button on the receiver. The Gain Mode indicator will change from "AUTO GAIN" to "MANUAL GAIN." The receiver gain will remain at its present value. A wide black segment on the Absolute Signal Strength bar graph indicates the signal level that will produce four arcs on the Relative Signal Strength display. Press the Increase Manual Gain ↑ button to increase the signal strength. Note that this will move the black bar to the left. Press the Decrease Manual Gain ↓ button to decrease the signal strength. Note that this will move the black bar to the right.

The CS-8000 Manual Gain feature requires several thousand steps to cover its full range. This allows very precise control of the gain. To make large changes in the Manual Gain setting, momentarily press the **Power/Signal Reset** button to align the Manual Gain value with the current signal level. To establish a wide search window, momentarily press the **Power/Signal Reset** button when the receiver is a distance away from the traced conductor. A greater distance will produce a wider window. To establish a narrow search window, momentarily press the **Power/Signal Reset** button when the receiver is close to the traced conductor.

Low Battery Indication: The receiver places "Low Battery" at the top of the LCD. The indication appears when approximately one hour of battery life is remaining under typical use conditions. The display backlight will dim to maximize the remaining battery life.

Automatic Power Off: The receiver will turn off after 30 minutes of inactivity. Activity means a change in signal level or pressing of the **Power/Signal Reset** button. The backlight will turn off after two minutes of inactivity. The backlight will automatically turn on again when a change in the signal is detected, or if a button is pressed.



Theory of Operation

The CS-8000 transmitter is intended for connection to an electrical line (up to 750 volts) or other metallic object. The transmitter signal consists of a controlled frequency with a specific modulation and timing that is different for live and open circuits. This composite signal gives it a specialized signature.

The transmitter signal generates a corresponding magnetic or electrostatic field signature around the conductor being traced. This field signature is present the entire length of the conductor, including breakers, fuses, switchgear, and transformers.

The CS-8000 receiver is tuned and programmed to pick up only the field signatures produced by the transmitter. To be received, the signal must have this exact frequency, modulation, and timing. This feature greatly reduces the possibility of interference from electrical noise, which is often caused by lamps, appliances, fluorescent fixtures, or machinery that is on the same line.

Both the transmitter and the receiver are microprocessor-controlled for maximum ease of use and accuracy.

Basic Operation

These instructions provide the user with a basic understanding of how the unit functions. These tests are best performed at a desk or bench.

Transmitter

1. Push and release the **Power** button. The Power LED illuminates, indicating unit power and signal being sent.
2. Plug the unit into any energized outlet. The Live Line LED also illuminates, indicating that the transmitter is connected to an energized circuit.
3. Unplug the unit. Push and release the **Power** button to turn the unit off.

Receiver

1. Push and release the **Power/Signal Reset** button to turn the receiver on.
2. The Transmitter Signal Indicator (segments of the red oval) will rotate, indicating the receiver is searching for a signal. The display will indicate the unit is set to "BREAKER MODE." A small blue bar will appear on the left side of the screen, indicating there is no signal strength available. A red bar at the end indicates the maximum signal the unit has received since Signal Reset. The unit will also read "AUTO GAIN", which is the default mode when the unit power is turned on.
3. Push and release the **Mode Selector** button. Indication will change from "BREAKER MODE" to "SEARCH MODE." This button toggles between the two available settings. Whenever this button is pushed, the signal strength automatically resets.
4. Push and release the up or down arrow button. Indication will change from "AUTO GAIN" to "MANUAL GAIN."
5. Push and hold the **Power/Signal Reset** button for approximately one second to set the unit back to "AUTO GAIN."
6. Push and hold the **Power/Signal Reset** button to turn the receiver off.

Basic Operation (cont'd)

Using the Transmitter and Receiver as a Set

1. Connect a cord to the transmitter. Push and release the **Power** button.
2. Hold the receiver approximately six inches from the cord, and then push and release the receiver's **Power/Signal Reset** button. The Transmitter Signal Indicator will be a solid blue oval. Relative Signal Strength display bars will appear on screen along with an audible signal beep.
3. Push and release the **Mode Selector** button to toggle to "SEARCH MODE." Moving the unit back and forth or to and from the transmitter cord will demonstrate how the Variable Signal Strength bars operate. The unit is set to "AUTO GAIN" so it will fine tune, creating less range but more definition as you get closer to the transmitter cord. The Variable Signal Strength bars can be reset to full level at any time by pushing and releasing the **Power/Signal Reset** button.
4. With all Variable Signal Strength bars displayed, push the up or down arrow, which will change the display from "AUTO GAIN" to "MANUAL GAIN." Push the down arrow to reduce the number of Variable Signal Strength bars, or the up arrow to increase the number of Variable Signal Strength bars. The signal will remain at the same setting until the unit is reset using the **Power/Signal Reset** button.
5. Hold the **Power/Signal Reset** button down for approximately one second and then release, which will switch the unit back to "AUTO GAIN."
6. Push and hold the **Power/Signal Reset** button to turn the receiver off. Push and release the **Power** button to turn the transmitter off.



Identifying Circuit Breakers or Fuses

The CS-8000 can identify which circuit breaker or fuse controls a circuit. It can also identify which panel contains the circuit breaker or fuse when there are several panels in the installation. Identification is usually performed using the Auto Gain Mode.

This procedure is most effective when the circuit is live because the transmitter signal is much stronger on live circuits. If the panel controlling an open circuit can not be found using this procedure, trace the circuit from the transmitter to the panel. Refer to the “Tracing Circuits and Metallic Objects” section. Note that the transmitter must be connected using a separate ground for best tracing results.

If the breaker or fuse can not be identified with the panel cover in place, remove the panel cover and place the receiver’s sensing surface in contact with each wire feeding a breaker or fuse.

Connecting the Transmitter

1. To identify the breaker or fuse controlling a standard North American receptacle, connect the adapter assembly to the transmitter. Insert the plug into the receptacle. Go to step 3.
2. To identify the breaker or fuse controlling other receptacles or circuits, use the appropriate test leads and accessories. Refer to “Typical Applications.” Always connect to the ground or neutral first, and then to the energized conductor.
3. Press and release the transmitter’s **Power** button.

Using the Receiver

1. Press and release the receiver’s **Power**  button. The LCD display will turn on. If the transmitter signal is detected, the transmitter Signal Indicator will be solid blue and the line status will be indicated. The unit will display “LIVE” if the transmitter is connected to an energized circuit. It will display “OPEN” if the transmitter is connected to a de-energized or grounded circuit.
2. Take the receiver to the vicinity of the circuit breaker panel. Press the **Mode Selector** button to place the receiver in Search Mode. If a signal is received, move the receiver toward the panel to produce an increase in signal strength. Sweep the receiver around all four edges of the panel door to locate the strongest signal. If there is more than one panel, repeat this process on all panels without resetting the receiver. The panel with the strongest signal contains the circuit breaker or fuse that is connected to the transmitter.
3. Open the panel door. Press the **Mode Selector** button to place the receiver in Breaker Mode. Move the receiver over all the breakers in the panel. The sensing surface of the receiver should be in contact with the circuit breakers. Move the receiver in a straight line so it passes over the same area of each breaker in the panel. The receiver may detect signal on several breakers during this first pass as the Auto Gain adjusts to the strongest signal.
4. Move the receiver slowly over all the breakers in the panel. The breaker or fuse providing the strongest signal (the most arcs on the Variable Signal Strength display) is the one powering the circuit that is connected to the transmitter. If there is more than one breaker with a strong signal, sweep the receiver across the entire face of each of these breakers to find the precise location of the strongest signal.

If there is any doubt as to which is the correct breaker or fuse due to unusual breaker design, mixed types of breakers in the panel, wiring, or the possibility that two breakers are feeding the same circuit, remove the panel trim and place the receiver’s sensing surface against each wire where it connects to the breaker.

Identifying Circuit Breakers or Fuses (cont'd)

IMPORTANT: Panel trim can distort the signal when locating breakers on the outside corners of the panel. This can cause the CS-8000 receiver to sense a stronger signal level on the adjacent breaker instead of the correct breaker in the corner. Before turning off or labeling any breaker next to the corner breaker, confirm it is the correct breaker by removing panel trim and repeating the slow sweep of all breakers in the panel. If there is any doubt of the correct active breaker, remove the panel trim and place the receiver's sensing surface against each wire where it connects to the breaker.

You can also continue to follow the power line by locating the remote main breaker in the same fashion. Since the signal is on a single-phase circuit, you can even find which leg of the breaker is feeding the transmitter.

Tracing Circuits and Metallic Objects / Finding Breaks and Shorts

The CS-8000 can perform a variety of tracing tasks on live circuits, open circuits, and other metallic objects. It can also locate breaks and shorts in circuit conductors. These operations can be performed on unshielded wiring or wiring in non-metallic conduit.

The connection and operation of the CS-8000 are similar for all these applications.

Connecting the Transmitter

The transmitter should use a separate ground unless it is connected to a live, GFCI-protected circuit. A separate ground means connecting the transmitter to a ground that is physically separated from the area of the wire to be traced. Conduit, outlet boxes, and wire trays carrying the trace line do not create a separate ground path. If a separate or earth ground is not readily available, a capacitive or "soft" ground to a metal chair or table may be used. Sensitivity and range are reduced.

Use of a "hard" separate ground connection with a GFCI-protected circuit will cause the GFCI device to trip. Tracing these circuits must be done with the transmitter connected to the line and neutral, or using a "soft" ground.

Tracing an electrical circuit: Connect the transmitter to the ungrounded ("hot") conductor. If this conductor has an open, the transmitter may be connected to the neutral or ground conductor. However, these conductors are more likely to have multiple connections that can make tracing very difficult.

Tracing coax cable and other low-voltage wiring: Disconnect the cable at the point to be connected to the transmitter. If the cable has a shield, connect the transmitter to this shield. Otherwise, connect the transmitter to any convenient conductor. The cable may be grounded or ungrounded at the far end, opposite the transmitter. The signal will be stronger if the far end is grounded.

Tracing metallic conduit: The CS-8000 can trace metallic conduit if the conduit is grounded only at the circuit breaker panel. Conduit in contact with metal will create multiple ground paths, which cannot be traced.

Finding breaks and shorts: Trace the conductor to the location where the signal disappears. This will be the location of the break or short. Breaker Mode can be used to locate the break or short more precisely.

1. Connect the transmitter using the appropriate test leads and accessories. Refer to "Typical Applications." Always connect to the ground or neutral first, and then to the energized conductor.
2. Press and release the transmitter's **Power** button.



Tracing Circuits and Metallic Objects / Finding Breaks and Shorts (cont'd)

Using the Receiver

The CS-8000 receiver incorporates patented, non-directional signal detection circuitry. It is not necessary to rotate the receiver when following the path of the traced object.

Press and release the receiver's **Power** button. Use the **Mode Selector** button to place the unit in Search Mode. Begin tracing near the transmitter. Scan the area with a sweeping motion across the suspected path of the traced object until you locate the signal. The receiver can pick up the signal radiating directly from the transmitter, instead of the signal on the traced object. Trace a short distance from the transmitter, and then press and release the **Power/Signal Reset** button. This sets the Auto Gain to the best level for tracing, without being influenced by this radiated signal.

The receiver will indicate you are within tracing distance using the Relative Signal Strength arcs on the LCD. If the signal is lost, press and release the **Power/Signal Reset** button and return to the signal that was last received. This will reset the signal level. The Auto Gain function will automatically turn down as you get closer to the signal wire. This creates the most accurate reading possible, based on the receiver's distance from the signal wire.

Manual Gain Mode can be used to maintain the gain at a constant setting, and to adjust the size of the sensitivity window.

Sorting Bundled Wires

The CS-8000 can sort unenergized wires that are bundled or run in the same conduit.

1. Connect the transmitter to the wire to be identified. Use a separate ground as described in the "Tracing Circuits and Metallic Objects" section above.
2. Proceed to the other end of the bundle. Set the receiver to Breaker Mode. Hold the receiver against every wire, even if no signal is indicated.
3. Hold the receiver against every wire a second time. The receiver should only show a strong signal on one wire. This is the wire connected to the transmitter.

Note: If coupling between the wires makes it impossible to identify the wire connected to the transmitter, return to the transmitter end of the bundle. Connect all wires to the separate ground except the wire to be identified. Repeat steps 2 and 3.

Typical Applications
Locating Breakers

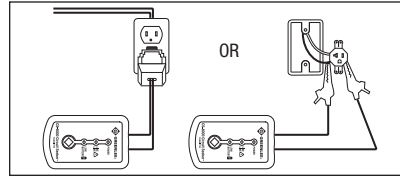

Locating the correct panel

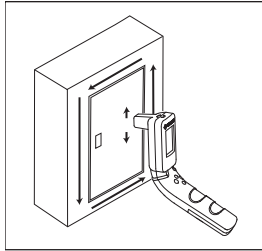

Scanning the breakers

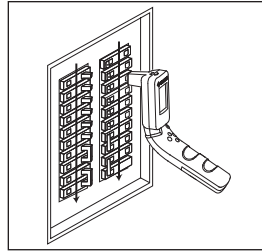

Checking the signal on the wire

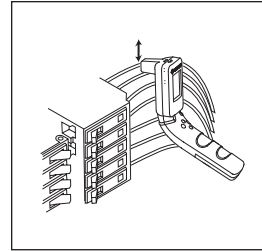

Finding the strongest signal on the breaker

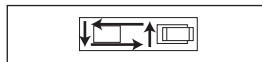

Tracing Circuits and Conduit

Tracing live GFCI-protected circuits

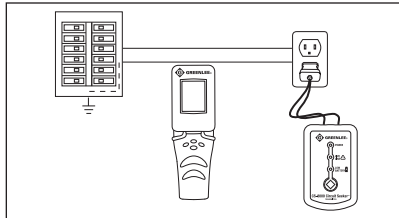

Tracing a circuit using a separate ground to a metallic object

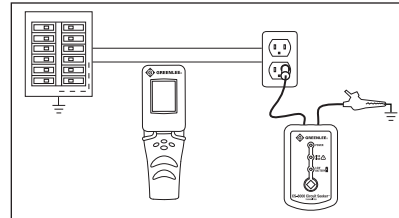

Tracing a circuit using a separate ground to a different branch circuit

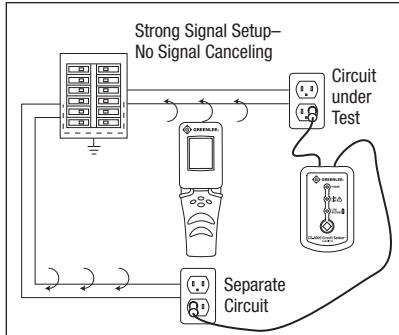

Tracing conduit, data (or other low voltage cable), or coax

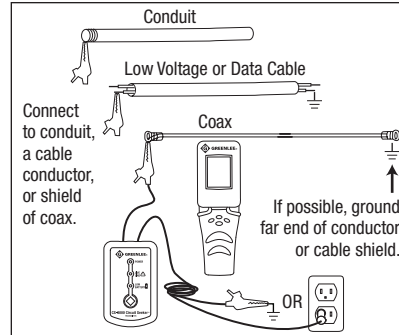

Typical Applications (cont'd)

Finding Breaks or Shorts

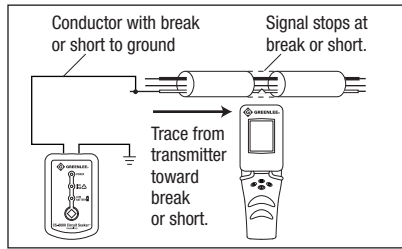

Sorting Wires

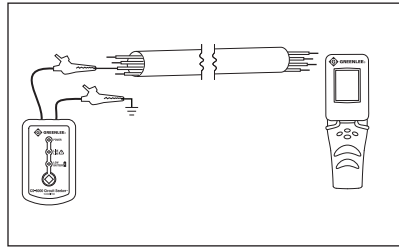

Tracing Signal Cancellation

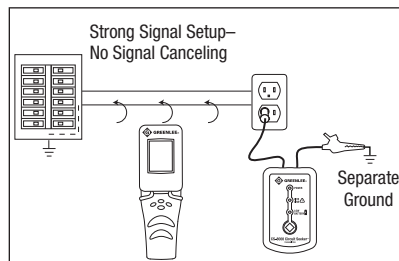
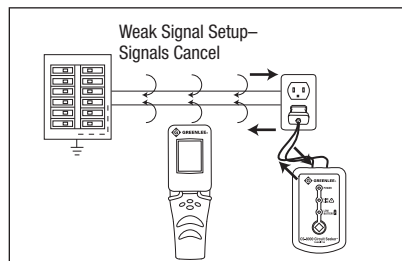

Connecting for Best Signal

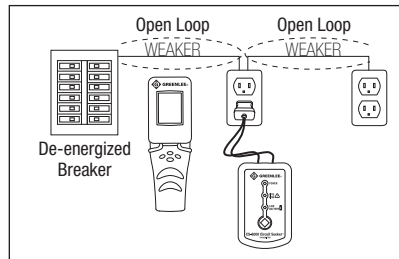
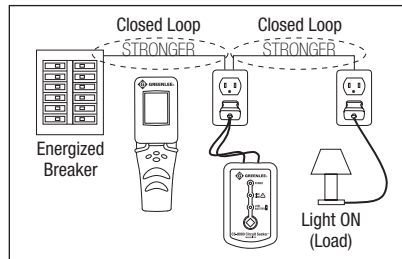
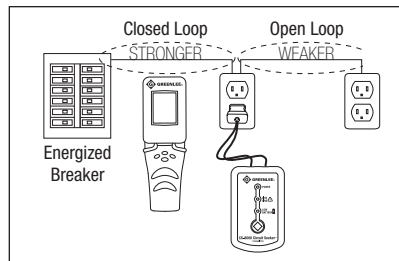
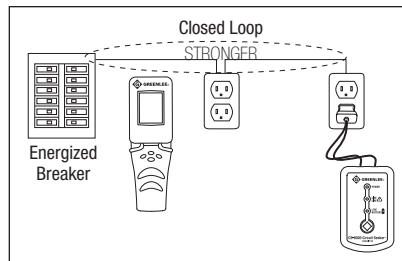

Specifications

Operating Conditions:

Temperature: 0 °C to 50 °C (32 °F to 122 °F)

Relative Humidity (non-condensing): 80% maximum for temperatures up to 31 °C (88 °F), decreasing linearly to 50% maximum at 49 °C (120 °F)

Indoor use only

Altitude: 2000 m (6500 ft) maximum

Pollution Degree: 2

Storage Conditions (remove batteries):

Temperature: -29 °C to 60 °C (-20 °F to 140 °F)

Relative Humidity (non-condensing): 0% to 70%

Measurement Category: Cat III, 750 V per IEC 61010-1

Transmitter Operating Voltage: 0 to 750 volts, AC/DC

Transmitter Operating Frequency: 15.15 kHz

Tracing Range:

Live Line Mode: Up to 6 m (20 ft) from circuit

Open Line Mode: Up to 3 m (10 ft) with a metallic connection to ground;
0.3 to 0.9 m (1 to 3 ft) with a capacitive ground reference

Auto Power Off Intervals:

Transmitter: 4 hours

Receiver: 30 minutes without signal

Receiver LCD: 2 minutes without signal, automatically turns on when signal is recaptured

Power Supply:

Transmitter: Two 1.5 V AA batteries

Receiver: Two 1.5 V AA batteries

Measurement Categories

These definitions were derived from the international safety standard for insulation coordination as it applies to measurement, control, and laboratory equipment. These measurement categories are explained in more detail by the International Electrotechnical Commission; refer to either of their publications: IEC 61010-1 or IEC 60664.

Measurement Category III

Distribution level. Permanently installed machines and the circuits they are hard-wired to. Some examples include conveyor systems and the main circuit breaker panels of a building's electrical system.

Measurement Category IV

Primary supply level. Overhead lines and other cable systems. Some examples include cables, meters, transformers, and other exterior equipment owned by the power utility.

Statement of Conformity

Greenlee Textron Inc. is certified in accordance with ISO 9001 (2000) for our Quality Management Systems.

The instrument enclosed has been checked and/or calibrated using equipment that is traceable to the National Institute for Standards and Technology (NIST).



Maintenance

⚠ CAUTION

Electric shock hazard:

- Do not attempt to repair this unit. It contains no user-serviceable parts.
- Do not expose the unit to extremes in temperature or high humidity. Refer to "Specifications."

Failure to observe these precautions may result in injury and can damage the unit.

Battery Replacement

⚠ WARNING

Electric shock hazard:

Before opening the case or battery compartment, remove the test leads from the circuit and shut off the unit.

Failure to observe this warning could result in severe injury or death.

1. Disconnect the unit from the circuit. Turn the unit off.
2. Remove the screw from the battery cover.
3. Remove the battery cover.
4. Replace the batteries (observe polarity).
5. Replace the cover and the screw.

Cleaning

Periodically wipe the case with a damp cloth and mild detergent; do not use abrasives or solvents.

Replacement Parts

Cat./UPC No.	Description	Qty
12849	Transmitter unit	1
12850	Receiver unit	1
12851	Carrying case	1
12852	AC plug adapter	1

Cat./UPC No.	Description	Qty
12853	Extension lead	2
10054	AC blade	1
10057	Alligator clip	2