

Infrared thermometers

Infrared video thermometers

Ratio pyrometer

Infrared cameras

Accessories / software / apps

PRODUCT OVERVIEW

Non-contact temperature measurement

when temperature matters

The adequate measurement device

Spot measurement or thermal image?

First of all, it is important to define the measurement task and to decide on one of these two measures:

Which measure?

A **point measuring infrared thermometer** should be used if you know where the critical point or the area to be measured is positioned within your application. The size of the measuring object is important to define which lens is necessary. It is therefore possible to monitor the accurate temperature and optimize processes – if necessary – before quality problems arise.

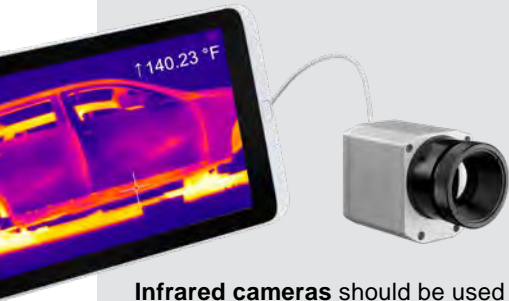

Infrared cameras should be used in cases where more than one critical area exists or the area cannot be clearly defined. Critical areas can be localized by the camera through the demonstration of thermal images. The areas can then be permanently monitored by one or multiple fixed infrared thermometers.



Which object surface?

The condition of the object surface defines the measurement device and wavelength to be used for the application. The **emissivity ϵ** occupies a central position.

The choice of the right device is of great importance especially for metals, where the emissivity depends on the temperature and wave length.

We are able to offer appropriate measurement devices for most applications throughout a wide product range.

The following explanation helps to find the right **wavelength** for your application:

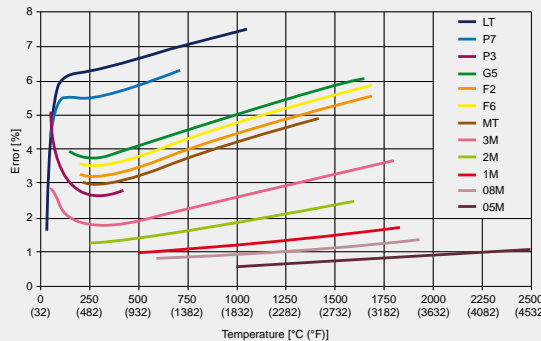

- **8 – 14 μm**
for non-metal surfaces (Type of device: LT)
- **0.5; 1.0; 1.6; 2.3 μm**
mainly for liquid metals and metal surfaces (Type of device: 05M; 08M; 1M; 2M; 3M; 4M)
- **3.43 μm**
for thin plastic films like PE, PP and PS (Type of device: P3)
- **3.9 ; 4.24; 4.64 μm**
for special applications (Type of device: MT; F2; F6)
- **5.0 μm**
for glass surfaces (Type of device: G5)
- **7.9 μm**
for plastic foils and glass surfaces (Type of device: P7/G7)

Short wavelengths reduce measurement errors on surfaces with low, unknown or changing emissivity. This occurs mostly with metals. The diagram above shows the measurement errors across different wavelengths if the emissivity is wrongly adjusted by only 10 percent.

Which temperature range?

The temperature is another factor to decide on. The range should cover all relevant temperatures of the application. The measurement range of the devices is between **-50 °C and 3000 °C (-58 °F and 5432 °F)**.

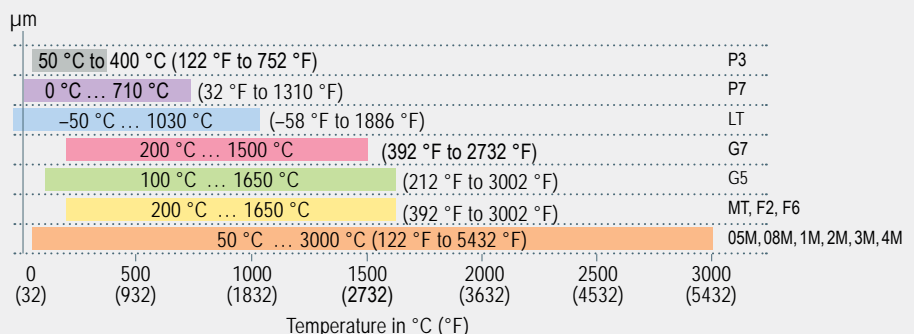

Display of temperature over wavelength for the devices of the compact and the high performance series

Which process velocity?

To achieve accurate temperature measurement it is important to know how fast measuring objects are moving in front of the sensor or how fast they change temperature.

Our fastest infrared thermometer captures changes within **1 ms**.

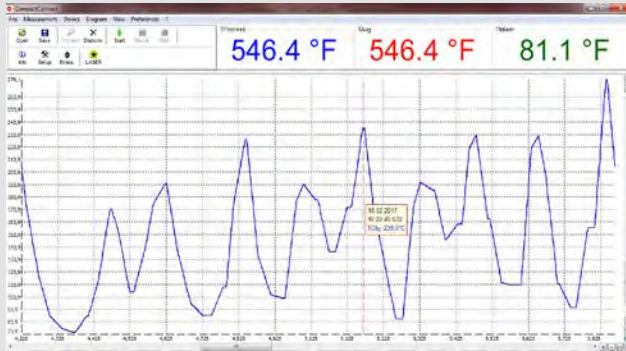

Display of fast temperature changes over a period of time.

Integration of sensors?

Our temperature sensors can be installed as part of the process with **mounting brackets** or **flanges**.

Depending on the device, we offer different analog and digital interfaces for **data evaluation** such as triggering, alerting or saving of data.

Analog Interfaces:

0 – 20 mA, 4 – 20 mA, 0 – 5 V, 0 – 10 V,
Thermocouple (type J, type K)

Digital Interfaces:

USB, RS232, RS485, Relay, Profibus DP, Modbus RTU,
Ethernet



Object size and measurement distance

IR thermometers use the radiation signal emitted by the entire measurement spot. The size of the measurement spot (S) largely depends on the device, the optics selected and the distance between the sensor and measurement object plane (D):

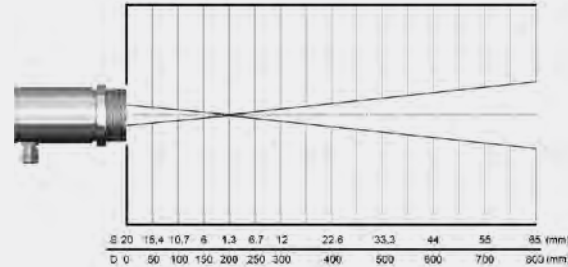

Measurement spot diameter (S) depending on the measurement distance (D) with an IR thermometer

For a precise temperature measurement, the measurement spot needs to be smaller than, or the same size as the object to be measured.

If the measurement spot is larger than the object, a temperature is calculated from the averaged heat radiation signal from the object and its environment. In a colder environment, it means that correspondingly, the temperature measurement value determined is too low.

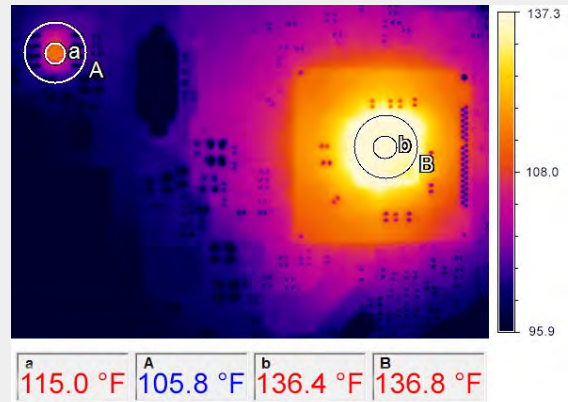

IR image of an electronics circuit board – adaptation of the measurement spot to the object size

When transferred to the two-dimensional measurement with IR cameras, the pixel size there needs to suit the object size for the selected measurement distance. Here, the object should fill at least 3 x 3 pixels.

In the example above, the correct temperature of a chip of 46 °C (114.8 °F) is determined with the suitable measurement spot size (a). A measurement spot (A) which is three times larger already leads to a measurement error of 5 °C (41 °F) or 10 %. If you select a larger component on the same circuit board (on the right in the picture), then in this case, both measurement spots (b and B) provide the correct temperature measurement value of 58 °C (136.4 °F).

optris CS/ CSmicro/ CT series

Infrared thermometers

Small, compact infrared thermometers, ideal for use in cramped and hot surroundings



CS series

**Single-piece pyrometer -
Electronic within sensing head**

In this device design, the optics are installed together with the electronics in a compact housing.



CSmicro series

**Single-piece pyrometer -
Electronic within cable**

To increase the robustness of the sensor head, Optris developed two-wire devices whose electronics are integrated into the cable. This makes the IR sensor, for example, significantly less sensitive to heat. In addition, the heat generated by the two-wire electronics has no influence on the thermal stability of the sensor head.



CT series

**Two-piece pyrometer - Sensing head
with separate electronic box**

As a third variant, a two-part device consisting of measuring head and separate electronics box is available. In addition to the simple device configuration and a temperature display, the electronics box offers the possibility to choose between different interfaces, such as USB, RS232, RS485, Modbus RTU, Profibus DP and Ethernet.

Infrared thermometers CS/ CSmicro series

Basic model

Type

Classification /
special features

Detector

Sensing head exchangeable

Head cable shortening

Thread (sensing head)

Spectral range

Temperature ranges

Temperature resolution

Optical resolution

Option: CF lens

Smallest spot (CF optics / add. CF lens)

Smallest spot (SF optics)

Sighting

Response time (90 %)

Accuracy

Analog O/P: 0-20 mA/4-20 mA/0-5 V/0-10 V/t/c (K/J)

Second analog output

Interfaces: USB / RS232 / RS485 /
Profibus / Ethernet / Modbus RTU / Relay

Peak / Valley / AVG / Advanced hold

T_{Amb} Head min.

T_{Amb} Head max.

T_{Amb} Electronics max.

Functional inputs/ number

External emissivity adjustment

External background temp. control / Trigger input
for reset of hold functions / Digital I/O pins

Simultaneous analog + digital O/P / Alarm O/P
as altern. to analog O/P / Additional alarm O/P

Voltage supply

Standard cable length options

CS	CSmicro	CSmicro	CSmicro	CSmicro
LT	LT02 / LT15 (H) / LT 22 H	LT15 HS	2M	3M
Single-piece sensor with smart LED display (self diagnostics, aiming support, alarm, temperature code)	Single-piece sensor with electronics in cable; smart LED display	Single-piece two-wire sensor with electronics in cable; high thermal sensitivity; smart LED display	Single-piece sensor for temp. measurements on metal ; electronics in cable; smart LED display	Single-piece sensor for temp. measurements on metal ; electronics in cable; smart LED display
Thermopile	Thermopile	Thermopile	InGaAs	Ext. InGaAs
-	-	-	-	-
■	■ (behind electronics)	■ (behind electronics)	■ (behind electronics)	■ (behind electronics)
M12x1	M12x1	M18x1	M12x1	M12x1
8–14 µm	8–14 µm	8–14 µm	1.6 µm	2.3 µm
-50 ... 1030 °C (-58 ... 1886 °F)	-50 ... 1030 °C (-58 ... 1886 °F)	-20 ... 150 °C (-4 ... 302 °F)	2ML: 250 ... 800 °C (482 ... 1472 °F) 2MH: 385 ... 1600 °C (725 ... 2912 °F)	3ML: 50 ... 350 °C (122 ... 662 °F) 3MH: 100 ... 600 °C (212 ... 1112 °F)
0.1 K	0.1 K	0.025 K [>20 °C (>68 °F)]	0.1 K	0.1 K
15:1	LT02: 2:1 / LT15 (H): 15:1 / LT22 H: 22:1	15:1	2ML: 40:1 2MH: 75:1	3ML: 22:1 3MH: 33:1
■	■	■	■	■
0.8 mm @ 10 mm (0.03 in @ 0.4 in)	LT02: 2.5 mm @ 23 mm (0.1 in @ 0.9 in) LT15 (H): 0.8 mm @ 10 mm (0.03 in @ 0.4 in) LT 22 H: 0.6 mm @ 10 mm (0.02 in @ 0.4 in)	0.8 mm @ 10 mm (0.03 in @ 0.4 in)	2MH: 1.5 mm @ 110 mm (0.06 in @ 4.3 in) 2ML: 2.7 mm @ 110 mm (0.11 in @ 4.3 in)	3ML: 1.5 mm @ 30 mm (0.06 in @ 1.2 in) 3MH: 1 mm @ 30 mm (0.04 in @ 1.2 in)
7 mm (0.3 in)	7 mm (0.3 in)	7 mm (0.3 in)	7 mm (0.3 in)	7 mm (0.3 in)
LED aiming	LED aiming	LED aiming	LED aiming	LED aiming
25 ms	LT: 14 ms / LTH: 150 ms	150 ms	8 ms (mA version: 20 ms)	8 ms (mA version: 20 ms)
±1.5% or ±1.5 °C (1.5% or ±3 °F)	±1% or ±1 °C (±1% or ±2 °F)	±1% or ±1 °C (±1% or ±2 °F)	±0.3% T _{Meas} + 2 °C (±0.3% T _{Meas} + 4 °F)	±0.3% T _{Meas} + 2 °C (±0.3% T _{Meas} + 4 °F)
- / - / ■ / ■ / ■	- / - / ■ / ■ / - or - / ■ / - / - / -	- / - / ■ / ■ / - or - / ■ / - / - / -	- / - / ■ / ■ / - or - / ■ / - / - / -	- / - / ■ / ■ / - or - / ■ / - / - / -
-	-	-	-	-
■ / - / - / - / - / - / -	■ / - / - / - / - / - / -	■ / - / - / - / - / - / -	■ / - / - / - / - / - / -	■ / - / - / - / - / - / -
■ / ■ / ■ / ■	■ / ■ / ■ / ■	■ / ■ / ■ / ■	■ / ■ / ■ / ■	■ / ■ / ■ / ■
-20 °C (-4 °F)	-20 °C (-4 °F)	-20 °C (-4 °F)	-20 °C (-4 °F)	-20 °C (-4 °F)
80 °C (176 °F)	LT02 / LT15: 120 °C (248 °F) LT15H / LT22H: 180 °C (356 °F)	75 °C (167 °F)	125 °C (257 °F)	85 °C (185 °F)
80 °C (176 °F)	80 °C (176 °F) / 75 °C (167 °F) (mA version)	80 °C (176 °F) / 75 °C (167 °F) (mA version)	80 °C (176 °F) / 75 °C (167 °F) (mA version)	80 °C (176 °F) / 75 °C (167 °F) (mA version)
■ / 1	■ / 1	■ / 1	■ / 1	■ / 1
■ (via V _{cc} adjust)	■ (mV version)	■ (mV version)	■ (mV version)	■ (mV version)
■ / ■ / -	■ (mV version) / ■ / -	■ (mV version) / ■ / -	■ (mV version) / ■ / -	■ (mV version) / ■ / -
- / ■ / ■	■ (mA version only) / ■ / ■	■ (mA version only) / ■ / ■	■ (mA version only) / ■ / ■	■ (mA version only) / ■ / ■
5–30 V DC	5–30 V DC	5–30 V DC	5–30 V DC	5–30 V DC
1 / 3 / 8 / 15 m (3.3 / 9.8 / 26.2 / 49.2 ft)	0.5 + 0.5 m / up to 9 m (1.6 ft / up to 29.5 ft)	0.5 + 0.5 m / up to 9 m (1.6 ft / up to 29.5 ft)	0.5 + 0.5 m / up to 9 m (1.6 ft / up to 29.5 ft)	0.5 + 0.5 m / up to 9 m (1.6 ft / up to 29.5 ft)

optris CS/ CSmicro/ CT series

Infrared thermometers
CT series









Basic model	CT	CTfast	CThot
Type	LT02 / LT15 / LT22	LT15F / LT25F	LT02H / LT10H
Classification / special features	Two-piece sensor with separate electronic box incl. programming keys and display	Two-piece sensor with fast response time and separate electronic box incl. programming keys and display	Two-piece sensor for hot surroundings with separate electronic box incl. programming keys and display
Detector	Thermopile	Thermopile	Thermopile
Sensing head exchangeable	■	-	■
Head cable shortening	■ [-0.1 K/m]	■ [max. 3 m] (9.8 ft)	■ [-0.1 K/m]
Thread (sensing head)	M12x1	M12x1	M18x1
Spectral range	8–14 μm	8–14 μm	8–14 μm
Temperature ranges	LT02: -50 ... 600 °C (-58 ... 1112 °F) LT15: -50 ... 600 °C (-58 ... 1112 °F) LT22: -50 ... 975 °C (-58 ... 1787 °F)	-50 ... 975 °C (-58 ... 1787 °F)	-40 ... 975 °C (-40 ... 1787 °F)
Temperature resolution	0.1 K	LT15F: 0.2 K / LT25F: 0.4 K	0.25 K
Optical resolution	LT02: 2:1 / LT15: 15:1 / LT22: 22:1	LT15F: 15:1 LT25F: 25:1	LT02H: 2:1 LT10H: 10:1
Option: CF lens	■	■	■
Smallest spot (CF optics/ add. CF lens)	LT02: 2.5 mm @ 23 mm (0.1 in @ 0.9 in) LT15: 0.8 mm @ 10 mm (0.03 in @ 0.4 in) LT22: 0.6 mm @ 10 mm (0.02 in @ 0.4 in)	0.5 mm @ 10 mm (0.02 in @ 0.4 in)	LT02H: 2.5 mm @ 23 mm (0.1 in @ 0.9 in) LT10H: 1.2 mm @ 10 mm (0.05 in @ 0.4 in)
Smallest spot (SF optics)	7 mm (0.3 in)	7 mm (0.3 in)	7 mm (0.3 in)
Sighting	-	-	-
Response time (90 %)	150 ms (95%)	LT15F: 9 ms / LT25F: 6 ms	100 ms
Accuracy	±1 °C or ±1 % (±2 °F or ±1 %)	±2 °C or ±1 % (±4 °F or ±1 %)	±1.5 °C or ±1 % (±3 °F or ±1 %)
Analog O/P: 0-20 mA/4-20 mA/0-5 V/0-10 V/t/c (K/J)	■ / ■ / ■ / ■ / ■	■ / ■ / ■ / ■ / ■	■ / ■ / ■ / ■ / ■
Second analog output	■	■	■
Interfaces: USB / RS232 / RS485 / Profibus / Ethernet / Modbus RTU / Relay	■ / ■ / ■ / ■ / ■ / ■	■ / ■ / ■ / ■ / ■ / ■	■ / ■ / ■ / ■ / ■ / ■
Peak / Valley / AVG / Advanced hold	■ / ■ / ■ / ■	■ / ■ / ■ / ■	■ / ■ / ■ / ■
T _{Amb} Head min.	-20 °C (-4 °F)	-20 °C (-4 °F)	-20 °C (-4 °F)
T _{Amb} Head max.	LT02: 130 °C (266 °F) LT15 / LT22: 180 °C (356 °F)	120 °C (248 °F)	250 °C (482 °F)
T _{Amb} Electronics max.	85 °C (185 °F)	85 °C (185 °F)	85 °C (185 °F)
Functional inputs/ number	■ / 3	■ / 3	■ / 3
External emissivity adjustment	■	■	■
External background temp. control / Trigger input for reset of hold functions / Digital I/O pins	■ / ■ / -	■ / ■ / -	■ / ■ / -
Simultaneous analog + digital O/P / Alarm O/P as altern. to analog O/P / Additional alarm O/P	■ / ■ / ■	■ / ■ / ■	■ / ■ / ■
Voltage supply	8–36 V DC	8–36 V DC	8–36 V DC
Standard cable length options	1 / 3 / 8 / 15 m (3.3 / 9.8 / 26.2 / 49.2 ft)	1 / 3 / 8 / 15 m (3.3 / 9.8 / 26.2 / 49.2 ft)	3 / 8 / 15 m (9.8 / 26.2 / 49.2 ft)

New

CT	CT	CT	CT	CT
1M / 2M	3M	4M	G5	P3 / P7
Two-piece sensor for high temp. meas. of metal with separate electronic box incl. programming keys and display	Two-piece sensor for low temp. meas. of metal with separate electronic box incl. programmin. keys and display	Two-piece sensor for low temp. and high speed meas. with separate electronic box incl. programming keys and display	Two-piece sensor for temp. meas. of glass with separate electronic box incl. programming keys and display	Two-piece sensor for temp. meas. on thin plastic film and glass (P7) with separate electronic box incl. programming keys and display
1M: Si / 2M: InGaAs	Erweiterter InGaAs	InAsSb	Thermopile	Thermopile (P7)
■	■	-	■	-
■ [max. 3 m] (9.8 ft)	■	■	■ [-0.1 K/m]	-
M12x1	M12x1	M12x1	M12x1	M18x1
1M: 1.0 µm / 2M: 1.6 µm	2.3 µm	2.2 – 6 µm	5.0 µm	P3: 3.43 µm / P7: 7.9 µm
1ML: 485... 1050 °C (905 ... 1922 °F) 1MH: 650 ... 1800 °C (1202 ... 3272 °F) 1MH1: 800 ... 2200 °C (1472 ... 3992 °F) 2ML: 250 ... 800 °C (482 ... 1472 °F) 2MH: 385 ... 1600 °C (725 ... 2912 °F) 2MH1: 490 ... 2000 °C (914 ... 3632 °F)	L: 50 ... 400 °C (122 ... 752 °F) H: 100 ... 600 °C (212 ... 1112 °F) H1: 150 ... 1000 °C (302 ... 1832 °F) H2: 200 ... 1500 °C (392 ... 2732 °F) H3: 250 ... 1800 °C (482 ... 3272 °F)	0 °C ... 500 °C (32 ... 932 °F)	L: 100 ... 1200 °C (212 ... 2192 °F) H: 250 ... 1650 °C (482 ... 3002 °F)	P3: 50 ... 400 °C (122 ... 752 °F) P7: 0 ... 710 °C (2 ... 1310 °F)
0.1 K	0.1 K	0.1 K	L: 0.1 K / H: 0.2 K	P3: 0.1 K / P7: 0.5 K
L: 40:1 H: 75:1	L: 22:1 / H: 33:1 / H1-H3: 75:1	10:1	L: 10:1 H: 20:1	P3: 15:1 P7: 10:1
■	■	■	-	-
1.5 mm @ 110 mm (0.06 in @ 4.3 in)	3.4 mm @ 110 mm (0.13 in @ 4.3 in)	5.0 mm @ 50 mm (0.2 in @ 2.0 in)	-	P7: 1.2 mm @ 10 mm (0.05 in @ 0.4 in)
7 mm (0.3 in)	7 mm (0.3 in)	7 mm (0.3 in)	7 mm (0.3 in)	7 mm (0.3 in)
-	-	-	-	-
1 ms	1 ms	300 µs (90 µs exposure time)	L: 120 ms / H: 80 ms	P3: 100 ms / P7: 150 ms
±0.3 % T _{Meas} +2 °C (±0.3 % T _{Meas} +4 °F)	±0.3 % T _{Meas} +2 °C (±0.3 % T _{Meas} +4 °F)	±0.3 % T _{Meas} +2 °C (±0.3 % T _{Meas} +4 °F)	±2 °C or ±1 % (±4 °F or ±1 %)	P3: ±3 °C (±5 °F) or 1 % P7: ±1.5 °C (±3 °F) or 1 %
■ / ■ / ■ / ■ / ■	■ / ■ / ■ / ■ / ■	■ / ■ / ■ / ■ / ■	■ / ■ / ■ / ■ / ■	■ / ■ / ■ / ■ / ■
-	-	■	■	■
■ / ■ / ■ / ■ / ■ / ■ / ■	■ / ■ / ■ / ■ / ■ / ■ / ■	■ / ■ / ■ / ■ / ■ / ■ / ■	■ / ■ / ■ / ■ / ■ / ■ / ■	■ / ■ / ■ / ■ / ■ / ■ / ■
■ / ■ / ■ / ■	■ / ■ / ■ / ■	■ / ■ / ■ / ■	■ / ■ / ■ / ■	■ / ■ / ■ / ■
-20 °C (-4 °F)	-20 °C (-4 °F)	0 °C (32 °F)	-20 °C (-4 °F)	P3: 0 °C (32 °F) / P7: -20 °C (-4 °F)
1M: 100 °C / 2M: 125 °C (1M: 212 °F / 2M: 257 °F)	85 °C (185 °F)	70 °C (158 °F)	85 °C (185 °F)	P3: 75 °C (167 °F) / P7: 85 °C (185 °F)
85 °C (185 °F)	85 °C (185 °F)	70 °C (158 °F)	85 °C (185 °F)	P3: 75 °C (167 °F) / P7: 85 °C (185 °F)
■ / 3	■ / 3	- / -	■ / 3	■ / 3
■	■	■	■	■
■ / ■ / -		■ / ■ / ■ (via I/O pins)	■ / ■ / ■	■ / ■ / -
■ / ■ / ■		■ / ■ / ■ (via I/O pins)	■ / ■ / ■	■ / ■ / ■
8-36 V DC	8-36 V DC	8-30 V DC / 5 V USB / max. 1.2 W	8-36 V DC	8-36 V DC
3 / 8 / 15 m (9.8 / 26.2 / 49.2 ft)	3 m (9.8 ft)	3 / 8 / 15 m (9.8 / 26.2 / 49.2 ft)	3 / 8 / 15 m (9.8 / 26.2 / 49.2 ft)	P3: 3m (9.8 ft) / P7: 8 / 15 m (26.2 / 49.2 ft)

Accessories CS/ CSmicro/ CT series





CTex LT + CTex LT hot	Mechanical accessories		
OPTCTEX	ACCTFB / ACCTFBMH / ACCTFB2	ACCTTAS	ACCTKF40B270 / ACCTKF40GE
<p>Aluminum housing with mounting device to accommodate the Zener barriers (top-hat rail) and the CT electronics</p> <p>Advantage</p> <ul style="list-style-type: none"> Two-piece measuring system with active electronic for evaluation and passive IR receiver (sensing head) CTex sensing head can be installed as passive element in hazardous areas Energy limitation with appropriate zener barriers (STAHL) with approval for zone 1 (PTB 01 ATEX 2053/ E II (1/2) GD [EEx ia/ib] IIC/IIB) 	<p>Mounting bracket, adjustable in one axis (M12x1 sensing head, massive housing, mounting of CT sensing head + Laser-Sightingtool)</p> 	<p>Tilt assembly for heads with optical resolution $\geq 10:1$</p> 	<p>KF40 flange for CT1M, 2M, 3M with B270 window (up to 10-7 mbar) / KF40 flange for CTLT with Ge window (up to 10-7 mbar)</p> 
	ACCTRAIL	ACCTMB	ACCTMG
	<p>Rail mount adapter for CT electronics</p> 	<p>Mounting bolt with thread M12x1</p> 	<p>Mounting fork, adjustable in 2 axes, with thread M12x1</p> 

Optical accessories		
ACCTCF / ACCTPW	ACCTCFE / ACCTPWE	D08ACCTLST / ACCTOEMLST
<p>CF-lens or protective window (for LT) for M12x1 sensing head ACCTCFHT / ACCTPWHT for 1M, 2M, 3M</p> 	<p>CF-lens or protective window (for LT) with external thread for air purge or massive housing ACCTCFHTE / ACCTPWHTe for 1M, 2M, 3M</p> 	<p>Laser-Sightingtool (for CT) / OEM Laser-Sightingtool, 635 nm, rotation symmetrical, for connection to CT electronics, power supply via CT electronic box or battery</p> 
ACCTRAM	ACCTPA + ACCTST20 / ACCTST40 / ACCTST88	
<p>Right angle mirror for measurements 90° to the sensor axis for sensing heads with optical resolution $\geq 10:1$</p> 	<p>Pipe adapter with M12x1 internal thread + Sighting tube with M12x1 external thread</p> 	<p> ACCTST20 (20 mm [0.78 in] length)  </p> <p> ACCTST40 (40 mm [1.57 in] length)  </p> <p> ACCTST88 (88 mm [3.46 in] length)  </p>

Air purges and protective housings

ACCSAP	ACCTAPMH	Massive housing of:	
Air purge collar (for heads with optical resolution $\geq 10:1$)	Air purge collar for Massive housing (D06)/ CSmicro HS / CThot / CT P3 / CT P7	<ul style="list-style-type: none"> • stainless steel (D06ACCTMHS) • compact, brass (D06ACCTMHB) • anodized aluminium (D06ACCTMHA) 	<ul style="list-style-type: none"> • stainless steel version with CF optics (D06ACCTMHSCF) • stainless steel version for HT CF optics (D06ACCTMHSCFHT)
			
ACCTAPLCFHT	ACCTAPL	ACCTAP / ACCTAP2 (2:1 optics)	
Air purge collar, laminar, with integrated CF lens (for 1M/ 2M/ 3M)	Air purge collar, laminar	Air purge for CT heads (not for heads with 32 mm [1.25 in] length)	
			

Combinations

ACCTAPL	ACCTMG		ACCTFB2	D08ACCTLST / ACCTOEMLST	
Air purge collar, laminar	Mounting fork	Device adjustable in two axes	Mounting bracket for sensing head + Sighting tool	OEM Laser-Sightingtool	Sensing head with Laser-Sighting tool
					
ACCTFB	ACCTMB	ACCTAB	D06ACCTAPMH	ACCTAPMH	
Mounting bracket for M12x1 sensing head	Mounting bolt	Device adjustable in two axes	Massive housing, stainless steel	Airpurge, stainless steel	Massive housing with air purge
					

Infrared thermometers

with highest optical resolution
and double laser



CSlaser series

Single-piece - Electronic within sensing head

Probably the most space-saving design is the one-piece measuring head. Optics and electronics are built into one compact device.

CTlaser series

Two-piece - Sensing head and separate electronic box



The two-part thermometer design consists of the measuring head and separate electronics box. In addition to easy device configuration and a temperature display, the electronics box offers the possibility to choose between different interfaces, such as USB, RS232, RS485, Modbus RTU, Profibus DP and Ethernet.



Ratio pyrometer

In metallurgy, a high emission of dust, smoke or vapor often cannot be avoided. A ratio thermometer ensures a reliable temperature measurement of melts or metallic surfaces even under these adverse conditions. The CTratio provides constant measurement results even with a partially dirty lens or for objects that move within the measurement area (e.g. metal rods or wires).



Infrared thermometers CSlaser series			
			
Basic model	CSlaser	CSlaser	CSlaser
Type	LT / hs LT	2M	G5
Classification / special features	Single-piece two-wire sensor with electronics in sensing head	Single-piece two-wire sensor with electronics in sensing head for measurement of metal	Single-piece two-wire infrared thermometer for temperature measurement of glass
Detector	Thermopile	InGaAs	Thermopile
Sensing head exchangeable	-	-	-
Head cable shortening	■	■	■
Thread (sensing head)	M48x1.5	M48x1.5	M48x1.5
Spectral range	8 – 14 μ m	1.6 μ m	5.0 μ m
Temperature ranges	LT: -30 ... 1000 °C (-22 ... 1832 °F) hs LT: -20 ... 150 °C (-4 ... 302 °F)	L: 250 ... 800 °C (482 ... 1472 °F) H: 385 ... 1600 °C (725 ... 2912 °F)	HF: 200 ... 1450 °C (392 ... 2624 °F) H1F: 250 ... 1650 °C (752 ... 3002 °F)
Temperature resolution	LT: 0.1 K / hs LT: 0.025 K	0.1 K	0.1 K
Optical resolution	50:1	2MH: 300:1 2ML: 150:1	HF / H1F: 45:1
Option: CF lens	-		
Smallest spot (CF optics/ add. CF lens)	1.4 mm @ 70 mm (0.06 in @ 2.8 in)	0.5 mm @ 150 mm (0.02 in @ 5.9 in)	1.6 mm @ 70 mm (0.06 in @ 2.8 in)
Smallest spot (SF optics)	24 mm @ 1200 mm (0.9 in @ 47.24 in)	3.7 mm @ 1100 mm (0.02 in @ 43.31 in)	27 mm @ 1200 mm (1.1 in @ 47.24 in)
Sighting	Double laser	Double laser	Double laser
Response time (90 %)	150 ms	10 ms	HF / H1F: 30 ms
Accuracy ¹⁾	± 1 °C or ± 1 % (± 2 °F or ± 1 %)	$\pm (0.3 \% T_{Meas} + 2$ °C) $\pm (0.3 \% T_{Meas} + 4$ °F)	± 1.5 °C or ± 1 % (± 3 °F or ± 1 %)
Analog O/P: 0 – 20 mA / 4 – 20 mA / 0 – 5 V / 0 – 10 V / t/c (K/J)	- / ■ / - / - / -	- / ■ / - / - / -	- / ■ / - / - / -
Second analog output	-	-	-
Interfaces: USB / RS232 / RS485 / Profibus / Ethernet / Modbus RTU / Relay	■ / - / - / - / - / - / -	■ / - / - / - / - / - / -	■ / - / - / - / - / - / -
Peak / Valley / AVG / Advanced hold	■ / ■ / ■ / ■	■ / ■ / ■ / ■	■ / ■ / ■ / ■
T _{Amb} Head min. / T _{Amb} Head max.	-20 °C (-4 °F) / 85 °C (185 °F)	-20 °C (-4 °F) / 85 °C (185 °F)	-20 °C (-4 °F) / 85 °C (185 °F)
T _{Amb} Electronics max.	85 °C (185 °F)	85 °C (185 °F)	85 °C (185 °F)
Functional inputs/ number	- / -	- / -	- / -
External emissivity adjustment	-	-	-
External background temp. control / Trigger input for reset of hold functions / Digital I/O pins	- / - / -	- / - / -	- / - / -
Simultaneous analog + digital O/P / Alarm O/P as altern. to analog O/P / Additional alarm O/P	■ / ■ / ■	■ / ■ / ■	■ / ■ / ■
Voltage supply	5 – 30 V DC	5 – 30 V DC	5 – 30 V DC
Standard cable length options	3 / 8 / 15 m (9.8 / 26.2 / 49.2 ft)	3 / 8 / 15 m (9.8 / 26.2 / 49.2 ft)	3 / 8 / 15 m (9.8 / 26.2 / 49.2 ft)

¹⁾ At object temperatures >0 °C (32 °F), $\epsilon = 1$

optris CTlaser series/ Ratio pyrometer

Infrared thermometers CTlaser series				
Basic model	CTlaser	CTlaser	CTlaser	CTlaser
Type	LT / LTF	05M	1M / 2M	3M
Classification / special features	Two-piece sensor with separate electronic box with fast response time, incl. programming keys and display	Two-piece sensor with separate electronic box for high temp. measurement of liquid metal, incl. programming keys and display	Two-piece sensor with separate electronic box for high temp. measurement of metal, incl. programming keys and display	Two-piece sensor with separate electronic box for low temp. measurement of metal, incl. programming keys and display
Detector	Thermopile	Si	1M: Si / 2M: InGaAs	Extended InGaAs
Sensing head exchangeable	■	■	■	■
Head cable shortening	■ [max. 6 m] (19.7 ft)	■ [max. 6 m] (19.7 ft)	■ [max. 6 m] (19.7 ft)	■ [max. 6 m] (19.7 ft)
Thread (sensing head)	M48x1.5	M48x1.5	M48x1.5	M48x1.5
Spectral range	8–14 µm	0.525 µm	1M: 1.0 µm 2M: 1.6 µm	2.3 µm
Temperature ranges	–50 ... 975 °C (–58 ... 1787 °F)	1000 ... 2000 °C (1832 ... 3632 °F)	1M: 485 ... 1050 °C (905 ... 1922 °F) 1MH: 650 ... 1800 °C (1202 ... 3272 °F) 1MH1: 800 ... 2200 °C (1472 ... 3982 °F) 2M: 250 ... 800 °C (482 ... 1472 °F) 2MH: 385 ... 1600 °C (725 ... 2912 °F) 2MH1: 490 ... 2000 °C (914 ... 3632 °F)	L: 50 ... 400 °C (122 ... 752 °F) H: 100 ... 600 °C (212 ... 1112 °F) H1: 150 ... 1000 °C (302 ... 1832 °F) H2: 200 ... 1500 °C (392 ... 2732 °F) H3: 250 ... 1800 °C (482 ... 3272 °F)
Temperature resolution	LT: 0.1 K / LTF: 0.5 K	0.2 K	0.1 K	0.1 K
Optical resolution	LT: 75:1 LTF: 50:1	150:1	L: 150:1 H: 300:1	L: 60:1 / H: 100:1 / H1 - H3: 300:1
Option: CF lens	–	–	–	–
Smallest spot (CF optics/add. CF lens)	LT: 0.9 mm @ 70 mm (0.04 in @ 2.8 in) LTF: 1.4 mm @ 70 mm (0.06 in @ 2.8 in)	–	0.5 mm @ 150 mm (0.02 in @ 5.9 in)	0.5 mm @ 150 mm (0.02 in @ 5.9 in)
Smallest spot (SF optics)	LT: 16 mm @ 1200 mm (LT: 0.6 in @ 47.24 in) LTF: 24 mm @ 1200 mm (LTF: 0.9 in @ 47.24 in)	7.3 mm @ 1100 mm (0.29 in @ 43.31 in)	3.7 mm @ 1100 mm (0.15 in @ 43.31 in)	11 mm @ 1100 mm (0.4 in @ 43.31 in)
Sighting	Double laser	Double laser	Double laser	Double laser
Response time (90%)	LT: 120 ms / LTF: 9 ms	1 ms	1 ms	1 ms
Accuracy	LT: ±1 °C or ±1 % (±2 °F or ±1 %) LTF: ±1.5 °C or ±1 % (±3 °F or ±1 %)	±(0.3 % T _{Meas} + 2 °C) ±(0.3 % T _{Meas} + 4 °F)	±(0.3 % T _{Meas} + 2 °C) ±(0.3 % T _{Meas} + 4 °F)	±(0.3 % T _{Meas} + 2 °C) ±(0.3 % T _{Meas} + 4 °F)
Analog O/P: 0–20 mA/4–20 mA/0–5 V/0–10 V/t/c (K/J)	■ / ■ / ■ / ■ / ■	■ / ■ / ■ / ■ / ■	■ / ■ / ■ / ■ / ■	■ / ■ / ■ / ■ / ■
Second analog output	■	–	–	–
Interfaces: USB / RS232 / RS485 / Profibus / Ethernet / Modbus RTU / Relay	■ / ■ / ■ / ■ / ■ / ■	■ / ■ / ■ / ■ / ■ / ■	■ / ■ / ■ / ■ / ■ / ■	■ / ■ / ■ / ■ / ■ / ■
Peak / Valley / AVG / Advanced hold	■ / ■ / ■ / ■	■ / ■ / ■ / ■	■ / ■ / ■ / ■	■ / ■ / ■ / ■
T _{Amb} Head min. / T _{Amb} Head max.	–20 °C (–4 °F) / 85 °C (185 °F)	–20 °C (–4 °F) / 85 °C (185 °F)	–20 °C (–4 °F) / 85 °C (185 °F)	–20 °C (–4 °F) / 85 °C (185 °F)
T _{Amb} Electronics max.	85 °C (185 °F)	85 °C (185 °F)	85 °C (185 °F)	85 °C (185 °F)
Functional inputs/ number	■ / 3	■ / 3	■ / 3	■ / 3
External emissivity adjustment	■	■	■	■
External background temp. control / Trigger input for reset of hold functions / Digital I/O pins	■ / ■ / –	■ / ■ / –	■ / ■ / –	■ / ■ / –
Simultaneous analog + digital O/P / Alarm O/P as altern. to analog O/P / Additional alarm O/P	■ / ■ / ■	■ / ■ / ■	■ / ■ / ■	■ / ■ / ■
Voltage supply	8–36 V DC	8–36 V DC	8–36 V DC	8–36 V DC
Standard cable length options	3 / 8 / 15 m (9.8 / 26.2 / 49.2 ft)	3 / 8 / 15 m (9.8 / 26.2 / 49.2 ft)	3 / 8 / 15 m (9.8 / 26.2 / 49.2 ft)	3 / 8 / 15 m (9.8 / 26.2 / 49.2 ft)

New

CTlaser	CTlaser	CTlaser	CTlaser	CTlaser	CTratio
4M	MT / F2 / F6	G5	G7	P7	1M / 2M
Two-piece sensor for low temp. and high speed meas. with separate electronic box incl. programming keys and display	Two-piece sensor with separate electronic box incl. progr. keys and display for measurement: MT: through flames / F2: CO ₂ flame gas / F6: CO flame gas	Two-piece sensor with separate electronic box for measurement of glass , incl. programming keys and display	Two-piece sensor with separate electronic box for measurement of ultra-thin glass sheets, incl. programming keys and display	Two-piece sensor with separate electronic box for measurement of ultra-thin plastic foils , incl. programming keys and display	Ratio pyrometer with separate electronic box for high temp. measurement of metal with green laser, incl. programming keys and display
InAsSb	Thermopile	Thermopile	Thermopile	Thermopile	Sandwich
-	■	■	■	■	-
■	■ [max. 6 m] (19.7 ft)	■ [max. 6 m] (19.7 ft)	■ [max. 6 m] (19.7 ft)	■ [max. 6 m] (19.7 ft)	-
M48x1.5	M48x1.5	M48x1.5	M48x1.5	M48x1.5	M18x1
2.2 – 6 µm	MT: 3.9 µm / F2: 4.24 µm / F6: 4.64 µm	5.0 µm	7.9 µm	7.9 µm	1M: 0.8 – 1.1 µm 2M: 1.45 – 1.75 µm
0 °C ... 500 °C (32 ... 932 °F)	MT / F2 / F6: 200 ... 1450 °C (392 ... 2642 °F) MTH / F2H / F6H: 400 ... 1650 °C (752 ... 3002 °F)	L: 100 ... 1200 °C (212 ... 2192 °F) H: 250 ... 1650 °C (482 ... 2912 °F) HF: 200 ... 1450 °C (392 ... 2642 °F) H1F: 400 ... 1650 °C (752 ... 3002 °F)	100 ... 1200 °C (32 ... 2192 °F)	0 ... 710 °C (32 ... 1310 °F)	1ML: 525 ... 1400 °C (977 ... 2552 °F) 1MH: 700 ... 2000 °C (1292 ... 3632 °F) 1MH1: 1000 ... 3000 °C (1832 ... 5432 °F) 2ML: 275 ... 1000 °C (527 ... 1832 °F) 2MH: 400 ... 1500 °C (752 ... 2732 °F) 2MH1: 550 ... 3000 °C (1022 ... 5432 °F)
0.1 K	0.1 K	0.1 K	0.5 K	0.5 K	0.1 K (> 900 °C)
30:1	45:1	L / HF / H1F: 45:1 H: 70:1	45:1	45:1	1ML / 2ML: 38:1 / 2MH: 50:1 / 1MH / 1MH1 / 2MH1: 100:1
■	-	-	-	-	■
2.4 mm @ 70 mm (0.9 @ 2.8 in)	1.6 mm @ 70 mm (0.06 in @ 2.8 in)	1 mm @ 70 mm (0.04 in @ 2.8 in)	1.6 mm @ 70 mm (0.06 in @ 2.8 in)	1.6 mm @ 70 mm (0.06 in @ 2.8 in)	1.5 mm @ 150 mm (0.06 in @ 5.9 in)
36.7 mm @ 1100 mm (1.44 in @ 43.31 in)	27 mm @ 1200 mm (1.1 in @ 47.24 in)	17 mm @ 1200 mm (0.7 in @ 47.24 in)	27 mm @ 1200 mm (1.1 in @ 47.24 in)	27 mm @ 1200 mm (1.1 in @ 47.24 in)	3 mm @ 300 mm (0.12 in @ 11.8 in)
Double laser	Double laser	Double laser	Double laser	Double laser	Laser
300 µs (90 µs exposure time)	10 ms	L: 120 ms / H: 80 ms HF/ H1F: 10 ms	150 ms	150 ms	1 ms – 10 s
±(0.3 % T _{Meas} + 2 °C) ±(0.3 % T _{Meas} + 4 °F)	±1 %	±1.5 °C or ±1 % (±3 °F or ±1 %)	±1.5 °C or ±1 % (±3 °F or ±1 %)	±1.5 °C or ±1 % (±3 °F or ±1 %)	±(0.5 % T _{Meas} + 2 °C) ±(0.5 % T _{Meas} + 4 °F)
■ / ■ / ■ / ■ / ■	■ / ■ / ■ / ■ / ■	■ / ■ / ■ / ■ / ■	■ / ■ / ■ / ■ / ■	■ / ■ / ■ / ■ / ■	■ / ■ / - / - / -
■	■	■	■	■	■
■ / ■ / ■ / - / ■ / ■ / ■	■ / ■ / ■ / ■ / ■ / ■ / ■	■ / ■ / ■ / ■ / ■ / ■ / ■	■ / ■ / ■ / ■ / ■ / ■ / ■	■ / ■ / ■ / ■ / ■ / ■ / ■	■ / ■ / ■ / - / ■ / ■ / ■
■ / ■ / ■ / ■	■ / ■ / ■ / ■	■ / ■ / ■ / ■	■ / ■ / ■ / ■	■ / ■ / ■ / ■	■ / ■ / ■ / ■
0 °C (32 °F) / 70 °C (158 °F)	-20 °C (-4 °F) / 85 °C (185 °F)	-20 °C (-4 °F) / 85 °C (185 °F)	-20 °C (-4 °F) / 85 °C (185 °F)	-20 °C (-4 °F) / 85 °C (185 °F)	-20 °C (-4 °F) / 200 °C (392 °F) (optional: 315 °C [599 °F])
70 °C (158 °F)	85 °C (185 °F)	85 °C (185 °F)	85 °C (185 °F)	85 °C (185 °F)	1M: 60 °C (140 °F), 2M: 50 °C (122 °F)
- / -	■ / 3	■ / 3	■ / 3	■ / 3	- / -
■	■	■	■	■	■
■ / ■ / ■ (via I/O pins)	■ / ■ / -	■ / ■ / -	■ / ■ / -	■ / ■ / -	■ / ■ (via I/O pins) / ■ (3)
■ / ■ / ■ (via I/O pins)	■ / ■ / ■	■ / ■ / ■	■ / ■ / ■	■ / ■ / ■	■ / ■ / ■ (via I/O pins)
8 – 30 V DC / 5 V USB / max. 1.2 W	8 – 36 V DC	8 – 36 V DC	8 – 36 V DC	8 – 36 V DC	8 - 30 V DC or USB
3 / 8 / 15 m (9.8 / 26.2 / 49.2 ft)	3 / 8 / 15 m (9.8 / 26.2 / 49.2 ft)	3 / 8 / 15 m (9.8 / 26.2 / 49.2 ft)	3 / 8 / 15 m (9.8 / 26.2 / 49.2 ft)	3 / 8 / 15 m (9.8 / 26.2 / 49.2 ft)	3 / 8 / 15 m (9.8 / 26.2 / 49.2 ft)

Infrared video thermometers CSvideo/ CTvideo with vario focus and patented cross hair laser				
		New		
Basic model	CSvideo	CSvideo	CTvideo	CTvideo
Type	2M (L/H)	3M (L/H)	1M / 2M (L/H)	3M (L/H)
Classification / special features	Single-piece two wire sensor with electronics in sensing head, video camera and cross hair laser for measuring metal	Single-piece two wire sensor for low temperature measurement of metals with electronics in sensing head, video camera and cross hair laser	Two-piece sensor with electronic box for high temperature measurement of metals , video camera and cross hair laser	Two-piece sensor with electronic box for low temperature measurement of metals , video camera and cross hair laser
Detector	InGaAs	InGaAs	1M: Si / 2M: InGaAs	Extended InGaAs
Sensing head exchangeable	-	-	[+CT 1M / 2M]	[+CT 3M]
Head cable shortening	■	■	[max. 6 m]	[max. 6 m]
Thread (sensing head)	M48x1.5	M48x1.5	M48x1.5	M48x1.5
Spectral range	1.6 µm	2.3 µm	1M: 1.0 µm / 2M: 1.6 µm	2.3 µm
Temperature ranges (scalable via software)	2ML: 250 °C ... 800 °C (482 °F ... 1472 °F) 2MH: 385 °C ... 1600 °C (725 °F ... 2912 °F)	3ML: 50 ... 400 °C (122 °F ... 752 °F) 3MH: 100 ... 600 °C (212 °F ... 1112 °F)	1ML: 485 °C ... 1050 °C (905 °F ... 1922 °F) 1MH: 650 °C ... 1800 °C (1202 °F ... 3272 °F) 1MH1: 800 °C ... 2200 °C (1472 °F ... 3992 °F) 2ML: 250 °C ... 800 °C (482 °F ... 1472 °F) 2MH: 385 °C ... 1600 °C (725 °F ... 2912 °F) 2MH1: 490 °C ... 2000 °C (914 °F ... 3632 °F)	3ML: 50 °C ... 400 °C (122 °F ... 752 °F) 3MH: 100 °C ... 600 °C (212 °F ... 1112 °F) ¹⁾ 3MH1: 150 °C ... 1000 °C (302 °F ... 1832 °F) ¹⁾ 3MH2: 200 °C ... 1500 °C (392 °F ... 2732 °F) ¹⁾ 3MH3: 250 °C ... 1800 °C (482 °F ... 3272 °F) ¹⁾
Temperature resolution	0.1 K	0.1 K	ML: 0.1 K / MH: 0.1 K	0.1 K
Optical resolution	2MH: 300:1 / 2ML: 150:1	3ML: 60:1 / 3MH: 100:1	L: 150:1 / H: 300:1	L: 60:1 / H: 100:1 / H1-H3: 300:1
Smallest spot (CF optics) CF vario optics: focusable from 90 mm to 250 mm (3.5 in to 9.8 in)	2ML: 0.6 mm @ 90 mm (CF) (0.02 in @ 3.5 in) 2MH: 0.3 mm @ 90 mm (CF) (0.01 in @ 3.5 in)	3ML: 1.5 mm @ 90 mm (0.06 in @ 3.5 in) 3MH: 0.9 mm @ 90 mm (0.04 in @ 3.5 in)	1ML/2ML: 0.6 mm @ 90 mm (CF) (0.02 in @ 3.5 in) 1MH-H1/ 2MH-H1: 0.3 mm @ 90 mm (CF) (0.01 in @ 3.5 in)	3ML: 1.5 mm @ 90 mm (CF) (0.06 in @ 3.5 in) 3MH: 0.9 mm @ 90 mm (CF) (0.04 in @ 3.5 in) 3MH1 - H3: 0.3 mm @ 90 mm (CF) (0.01 in @ 3.5 in)
Smallest spot (SF optics) SF vario optics: focusable from 200 mm (7.9 in) to infinity	2ML: 1.3 mm @ 200 mm (SF) (0.05 in @ 7.9 in) 2MH: 0.7 mm @ 200 mm (SF) (0.03 in @ 7.9 in)	3ML: 3.3 mm @ 200 mm (0.13 in @ 7.9 in) 3MH: 2.0 mm @ 200 mm (0.08 in @ 7.9 in)	1ML/2ML: 1.3 mm @ 200 mm (SF) (0.05 in @ 7.9 in) 1MH-H1/ 2MH-H1: 0.7 mm @ 200 mm (SF) (0.03 in @ 7.9 in)	3MH: 3.3 mm @ 200 mm (SF) (0.13 in @ 7.9 in) 3MH: 2.0 mm @ 200 mm (SF) (0.08 in @ 7.9 in) 3MH1 - H3: 0.7 mm @ 200 mm (SF) (0.03 in @ 7.9 in)
Sighting	video camera and cross hair laser	video camera and cross hair laser	video camera and cross hair laser	video camera and cross hair laser
Response time (90 %)	10 ms	20 ms	1 ms	1 ms
Accuracy	±(0.3 % T _{Meas} + 2 °C) ±(0.3 % T _{Meas} + 4 °F)	±(0.3 % T _{Meas} + 2 °C) ±(0.3 % T _{Meas} + 4 °F)	±(0.3 % T _{Meas} + 2 °C) ±(0.3 % T _{Meas} + 4 °F)	±(0.3 % T _{Meas} + 2 °C) ±(0.3 % T _{Meas} + 4 °F)
Outputs analog: 0-20 mA / 4-20 mA / 0-5 V / 0-10 V / t/c (K/J)	- / ■ / - / - / -	- / ■ / - / - / -	■ / ■ / ■ / ■ / ■	■ / ■ / ■ / ■ / ■
Interfaces: USB / RS232 / RS485 / Profibus / Ethernet	■ / - / - / - / ■	■ / - / - / - / ■	■ / - / - / - / ■	■ / - / - / - / ■
Signal processing: Peak / Valley / AVG / Advanced hold	■ / ■ / ■ / ■	■ / ■ / ■ / ■	■ / ■ / ■ / ■	■ / ■ / ■ / ■
T _{Amb} Head min. / T _{Amb} Head max.	-20 °C (-4 °F) / 70 °C (158 °F)	-20 °C (-4 °F) / 70 °C (158 °F) (50 °C [122 °F] at Laser ON)	-20 °C (-4 °F) / 70 °C (158 °F)	-20 °C (-4 °F) / 70 °C (158 °F)
T _{Amb} Electronics max.	70 °C (158 °F)	70 °C (158 °F)	85 °C (185 °F)	85 °C (185 °F)
Functional inputs / number	- / -	- / -	■ / 3	■ / 3
External emissivity adjustment	-	-	■	■
External background temperature control	-	-	■	■
Trigger input for reset of hold functions	-	-	■	■
Simultaneous analog and digital output	■	■	■	■
Alarm output as an alternative to analog output	■	■	■	■
Additional alarm output	0-30 V / 500 mA (open-collector)	0-30 V / 500 mA (open-collector)	24 V / 50 mA (open-collector)	24 V / 50 mA (open-collector)
Voltage supply	5-28 V DC	5-28 V DC	8-36 V DC	8-36 V DC
Standard cable length options	3 / 8 / 15 m (9.8 / 26.2 / 49.2 ft)	3 / 8 / 15 m (9.8 / 26.2 / 49.2 ft)	3 / 5 / 10 m (9.8 / 16.4 / 32.8 ft)	3 / 5 / 10 m (9.8 / 16.4 / 32.8 ft)

¹⁾ Specifications available for object temperature > lower measurement range 50 °C (122 °F)

Software pyrometer

Software CompactConnect / CompactPlus Connect

Suitable for all optris infrared thermometer of the high performance series and compact line

- Automatic snapshots (time or temperature dependent) to control and document the process
- Graphic display and recording of the measurement values
- Setup of sensor parameters and signal processing functions
- Remote control of the sensor

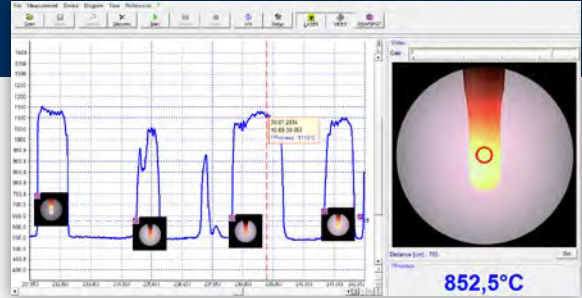

Connection options for CSvideo 2M

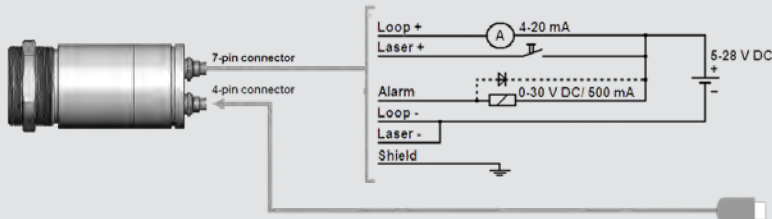

Analog operation mode:

4 – 20 mA and alarm interface

Setup & installation by IRmobile App via USB cable (Plug & Play)

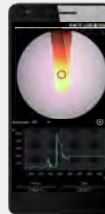
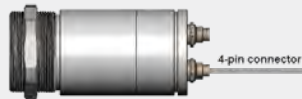

Digital operation mode:

process control (video and temperature) via IRmobile App

IRmobile App

tool for all optris thermometers

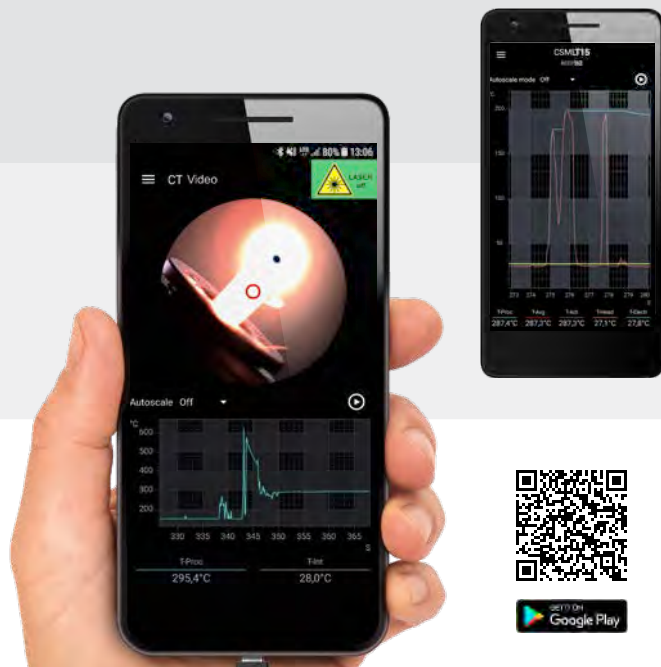

- Change of the temperature unit: Celsius or Fahrenheit
- Integrated simulator
- Save / load configurations and T/ t diagrams

Pyrometer

- Alignment of the sensor via live video image with integrated simultaneous temperature display (CSvideo / CTvideo)
- Adjustment of emissivity, transmissivity and other parameters
- Scaling the analog output and setting the alarm output

Supported for

- PI and Xi series and all pyrometers
- For Android devices from version 5.0 or higher with Micro-USB or USB-C connectors that support USB OTG (On The Go)



Accessories CSLaser/ CTlaser/ CSvideo/ CTvideo series

Mechanical accessories

ACCTLFB	ACCTLAB	ACHAMA	ACCTRAIL
Mounting bracket, adjustable in one axis	Mounting bracket, adjustable in two axes	Mounting adapter: Mounting and pipe flange incl. screws	Rail mount adapter for CT electronics
			

Optical accessories

Combinations

ACHAST300 + ACHAPA	ACCJAFPCTL + ACCJAPWCTLSW	ACHAMA	ACHAST300 + ACHAPA	ACCTLRM
Sighting tube M48x1.5, 300 mm (11.81 in) length + pipe adapter with M48x1.5 internal thread for CoolingJacket	Front part + Focussing unit with protective window for CoolingJacket	Mounting adapter	Sighting tube + pipe adapter	Furnace wall mount for CSLaser / CTlaser
				
				

Air purges and cooling units

ACCTAPMH	ACCTLAP	ACCTLW			
Air purge collar CTRatio	Air purge collar CxL / CxV	Water cooled housing CxL / CxV, stainless steel, for Tamb up to 175 °C (347 °F)			
					
ACCTLCJA	ACCJAAPLS	ACCTLAP	ACCTLW		
CoolingJacket Advanced	Air purge laminar for CoolingJacket Advanced	CoolingJacket Advanced with air purge laminar	Air purge collar	Water cooled housing	Cooling sensing head + purging of optics
					
					

Applications

Applications pyrometer



Laminating interior fittings of vehicles

Vehicle interiors are partly equipped with different surface decors during a laminating process. This process takes place at around 120 °C (248 °F) – the decor temperature is controlled and optimized during this time.

Recommended device:
CSmicro LT

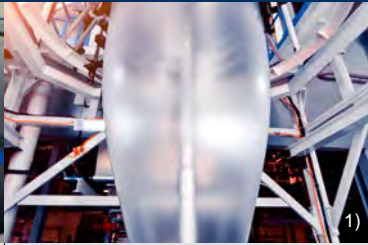

Blown film extrusion

From the moment the melt emerges through the die at the extruder, the temperature of the tubular film must be measured at different points in order to ensure product quality.

Recommended device:
CT P3



Sterilization of glass bottles

A sterilization of a defined temperature level is important to produce aseptic glass bottles for pharmaceutical products. The right temperature is secured and monitored by a punctual measuring pyrometer.

Recommended devices:
**CT G5,
CT LT**



Inductive heat treatment of metals

A variant of the heat treatment of metals is induction hardening. The desired microstructure of the metal depends on an optimal temperature-time curve.

Recommended device:
CTlaser 1M

Applications infrared cameras

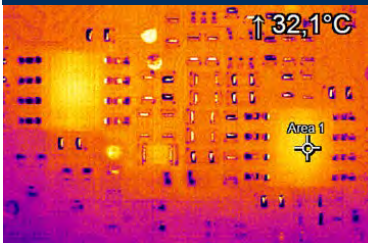

Component inspection of circuit boards

More and more manufacturers of electronic circuit boards rely on noncontact temperature measurement due to the constantly increasing performance of their components.

Recommended devices:
**PI 640i Microscope optics,
Xi 400 Microscope optics**

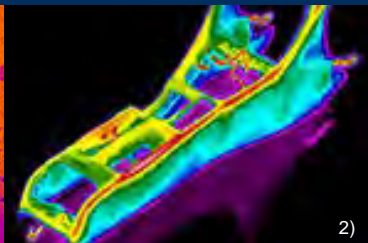

Injection molding

In order to prevent component distortion during injection molding, the process is monitored by thermal imaging cameras detecting and adjusting temperature over- or undershoots during molded part measurement.

Recommended device:
PI 450i

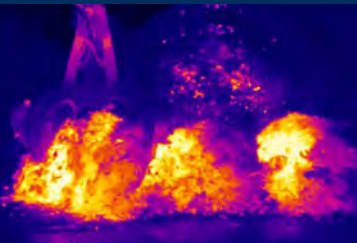

Infrared technology in waste processing

Early fire detection with infrared cameras is an important protective measure in industry to prevent irreparable damage to industrial plants and buildings.

Recommended device:
Xi 400



Workpiece control during drop forging

In drop forging, the semi-finished products must be at a certain forging temperature before forming. In order to achieve the optimum production result, the surface temperature of the material is controlled accordingly.

Recommended devices:
**PI 1M,
PI 05M**

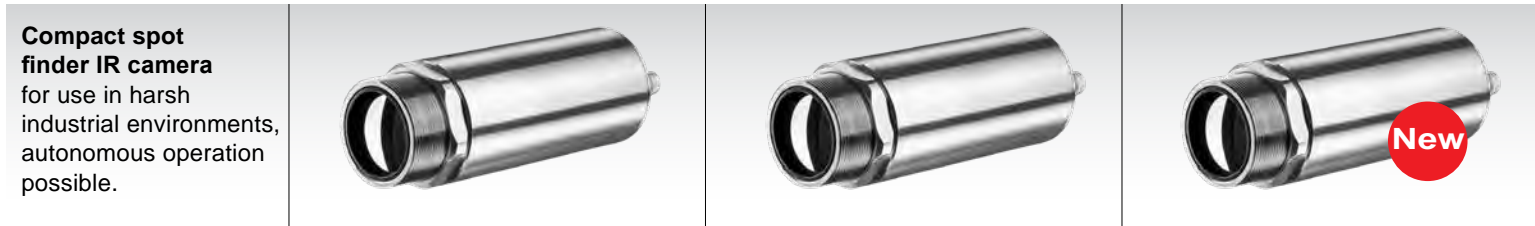

Basic model	Xi 80	Xi 400	Xi 410
Type	IR	IR	IR
Detector	FPA, uncooled (34 µm pitch)	FPA, uncooled (17 µm pitch)	FPA, uncooled (17 µm pitch)
Optical resolution	80 x 80 pixels	382 x 288 pixels	384 x 240 pixels
Spectral range	8–14 µm	8–14 µm	8–14 µm
Temperature ranges	–20 ... 100 °C (–4 to 212 °F) 0 ... 250 °C (32 to 482 °F) (20) 150 ... 900 °C ¹⁾ (302 ... 1652 °F ¹⁾)	–20 ... 100 °C (–4 to 212 °F) 0 ... 250 °C (32 to 482 °F) (20) 150 ... 900 °C ¹⁾ (302 ... 1652 °F ¹⁾) 200 ... 1500 °C (392 ... 2732 °F) (option)	–20 ... 100 °C (–4 to 212 °F) 0 ... 250 °C (32 to 482 °F) (20) 150 ... 900 °C ¹⁾ (302 ... 1652 °F ¹⁾)
Frame rate	50 Hz	80 Hz / 27 Hz	Ethernet: 25 Hz / USB: 4 Hz autonomous operation: (without PC): 1.5 Hz
Optics (FOV)	30° (f = 5.1 mm [0.20 in]) 12° (f = 12.7 mm [0.50 in]) 55° (f = 3.1 mm [0.12 in]) 80° (f = 2.3 mm [0.09])	29° x 22° (f = 12.7 mm [0.50 in]) 18° x 14° (f = 20 mm [0.79 in]) 53° x 38° (f = 7.7 mm [0.30 in]) 80° x 54° (f = 5.7 mm [0.22 in])	18° x 12° (f = 20 mm [0.79 in]) 29° x 18° (f = 12.7 mm [0.51 in]) 53° x 31° (f = 7.7 mm [0.31 in]) 80° x 44° (f = 5.7 mm [0.24 in])
New: Microscope optics	–	18° x 14° (f = 20 mm [0.79 in]), smallest measuring spot (IFOV): 80 µm	–
Focus	Manual motor focus	Manual motor focus	Manual motor focus
Optical resolution (D:S)	190:1 (12° optics)	390:1 (18° optics)	390:1 (18° optics)
Thermal sensitivity (NETD)	100 mK	80 mK	80 mK
Accuracy	±2 °C (±3.6 °F) or ±2 %, whichever is greater	±2 °C (±3.6 °F) or ±2 %, whichever is greater	±2 °C (±3.6 °F) or ±2 %, whichever is greater
PC interfaces	USB 2.0 / Ethernet (100 Mbit/s) / PoE	USB 2.0 / optional USB to GigE (PoE) interface	USB 2.0 / Ethernet (100 Mbit/s) / PoE
Direct in-/outputs / Standard process interface (PIF)	1x 0/4–20 mA output 1x input (analog or digital) electrically isolated	1x 0–10 V input 1x digital input (max. 24 V) 1x 0–10 V output	1x 0/4–20 mA output 1x input (analog or digital) electrically isolated
Industrial process interface (PIF)	3x analog outputs (0/4–20 mA or 0–10 V) or alarm OUT (relais) 3x inputs (analog or digital) fail-safe (LED and relay), stackable up to 3 PIFs; electrically isolated	2 x 0–10 V inputs, 1 x digital input (max. 24 V), 3x 0/4–20 mA outputs, 3 x relay (0–30 V / 400 mA), fail-safe relay	3x analog outputs (0/4–20 mA or 0–10 V) and 3x alarm outputs (relais) / 3x inputs (analog or digital) / fail-safe (LED and relay) stackable up to 3 PIFs; electrically isolated
Cable length (USB)	USB: 1 m, 3 m, 5 m (3.3 ft, 9.8 ft, 16.4 ft) Ethernet: 100 m (328 ft), RS485: 500 m (1640.4 ft)	USB: 1 m, 3 m, 5 m, 10 m, 20 m (3.3 ft, 9.8 ft, 16.4 ft, 32.8 ft)	USB: 1 m, 3 m, 5 m (3.3 ft, 9.8 ft, 16.4 ft) Ethernet: 100 m (328 ft), RS485: 500 m (1640.4 ft)
Ambient temperature	0 °C ... 50 °C (32 ... 122 °F)	0 °C ... 50 °C (32 ... 122 °F)	0 °C ... 50 °C (32 ... 122 °F)
Size / class	Ø 36 x 90 mm (1.41 x 3.54 in) (M30x1 thread) / IP 67 (NEMA 4)	Ø 36 x 100 mm (1.41 x 3.94 in) (M30x1 thread) / IP 67 (NEMA 4)	Ø 36 x 100 mm (1.41 x 3.94 in) (M30x1 thread) / IP 67 (NEMA 4)
Weight	201 - 210 g, (7.09 - 7.41 oz) depending on lens	216 - 220 g, (7.62 - 7.76 oz) depending on lens	216 - 220 g, (7.62 - 7.76 oz) depending on lens
Shock / Vibration²⁾	IEC 60068-2	IEC 60068-2	IEC 60068-2
Power supply	USB / PoE / 5-30 VDC	via USB	USB / PoE / 5-30 VDC
Scope of supply (standard)	<ul style="list-style-type: none"> • Xi camera • USB cable (1 m [3.3 ft]) • Cable for in-/outputs (1 m [3.3 ft]) with terminal block • Mounting bracket with tripod thread, mounting nut • Software package optris PIX Connect • Quick start guide 	<ul style="list-style-type: none"> • Xi camera • USB cable (1 m [3.3 ft]) • Cable for in-/outputs (1 m [3.3 ft]) with terminal block • Mounting bracket with tripod thread, mounting nut • Software package optris PIX Connect • Quick start guide 	<ul style="list-style-type: none"> • Xi camera • Ethernet/ PoE cable (1 m [3.3 ft]) / USB cable (1 m [3.3 ft]) • IN/ OUT cable (1 m [3.3 ft]) incl. terminal block • Mounting bracket with tripod thread, mounting nut • Software package optris PIX Connect • Quick start guide

Microscope optics for the inspection of assembled circuit boards

The new microscope optics for the **optris Xi 400** infrared camera allows reliable temperature measurement on tiny objects from **240 µm (MFOV)**. In combination with a suitable stand, this enables professional measurement of printed circuit boards and components in the electronics industry. The measuring distance between camera and object is variable between 90 and 110 mm (3.54 and 4.33 in). Due to the built-in motor focus, the camera can be easily mounted in the supplied PIX Connect software focus. For measuring even smaller objects we recommend the PI 640i microscope optics, **smallest measuring spot: 28 µm (IFOV)**.

Further information on page 21 and



1) Accuracy effective starting at 150 °C (302 °F)







2) For further details see operator's manual

Accessories Xi series

Air purge unit	Water cooled housing	Shutter
ACXIAPL + ACXIAPLAB (Mounting bracket)	ACXIW	ACXISCBxx* + ACXIAPLAB (Mounting bracket)
<p>Features</p> <ul style="list-style-type: none"> The air purge attachment can be used in combination with the water cooled housing and protects the optics from contamination Used in rough and dusty areas to guarantee a reliable temperature measurement 	<p>Features</p> <ul style="list-style-type: none"> The rugged water cooled housing allows the Xi infrared cameras to be employed in hot environments up to 250 °C (482 °F) Respective heat-resistant cables are also available 	<p>Features</p> <ul style="list-style-type: none"> In addition Xi cameras can be equipped with a shutter The shutter protects the optics from falling parts within a response time of 100 ms
		<p><i>*) xx = for different cable lengths</i></p> 

Outdoor protective housing for Xi series	USB server Gigabit 2.0 for Xi 400	Industrial process interface (PIF) for Xi series
ACXIOPH24	ACPIUSBSGB	Xi 80 and Xi 410: ACXIPIFCBx* , Xi 400: ACPIPIFMCBx*
<p>Features</p> <ul style="list-style-type: none"> Environmental rating IP 66 Additional air purge collar allows continuous operation in dusty and humid environments Heating element and built-in fan enable for a 24/7 operation from -40 °C to 50 °C (-40 °F to 122 °F) Installation of USB Server Gigabit 2.0 and industrial process interface possible for integration into control systems over large outdoor distances 	<p>Features</p> <ul style="list-style-type: none"> Fully USB 2.0 compatible, Data rates: 1.5 / 12 / 480 mbps, USB transfer mode: Isochronous Network connection via Gigabit Ethernet Full TCP/IP support incl. routing and DNS Two independent USB ports Supply from PoE or external power supply with 24 – 48 V DC Galvanic isolation 500 VRMS (network connection) Remotely configurable via Web Based Management 	<p>Features</p> <ul style="list-style-type: none"> Industrial process interface for Xi 400 with 3 analog / alarm outputs, 2 analog inputs, 1 digital input, 3 alarm relays Industrial process interface for for Xi 80 and Xi 410 with 3 analog-/alarm outputs, 3 inputs (analog or digital), 3 alarm relays 500 V ACRMS isolation voltage between camera and process Separate fail-safe relay output Xi hardware including all cable connections and PIX Connect software are permanently observed during operation Option Xi 80: stackable up to 3 PIFs <p><i>*) x = for different cable lengths</i></p>
		

			
PI 640i	PI 640i Microscope optics	PI 450i G7	PI 640i G7
IR	IR	IR	IR
FPA, uncooled (17 µm pitch)	FPA, uncooled (17 µm pitch)	FPA, uncooled (17 µm pitch)	FPA, uncooled (17 µm pitch)
640 x 480 pixels VGA	640 x 480 pixels @ 32 Hz 640 x 120 pixels @ 125 Hz	382 x 288 pixels	640 x 480 pixels
8 – 14 µm	8 – 14 µm	7.9 µm	7.9 µm
-20 ... 100 °C (-4 ... 212 °F) 0 ... 250 °C (32 ... 482 °F) (20)150 ... 900 °C (302 ... 1652 °F) ¹⁾ 200 ... 1500 °C (392 ... 2732 °F) (option)	-20 ... 100 °C (-4 ... 212 °F) 0 ... 250 °C (32 ... 482 °F) (20)150 ... 900 °C (302 ... 1652 °F) ¹⁾ 200 ... 1500 °C (392 ... 2732 °F) (option)	150 ... 900 °C (302 ... 1652 °F) 200 ... 1500 °C (392 ... 2732 °F)	150 ... 900 °C (302 ... 1652 °F) 200 ... 1500 °C (392 ... 2732 °F)
32 Hz / 125 Hz in subframe mode (640x120 pixels)	32 Hz / 125 Hz in subframe mode (640 x 120 pixels)	80 Hz / switchable to 27 Hz	32 Hz / 125 Hz in subframe mode (640 x 120 pixels)
33° x 25° / f = 18.7 mm (0.74 in) or 15° x 11° / f = 41.5 mm (1.63 in) or 60° x 45° / f = 10.5 mm (0.41 in) or 90° x 64° / f = 7.7 mm (0.30 in)	12° x 9° (F=1.1) / f = 44 mm (1.73 in) Smallest measuring spot (IFOV): 28 µm	29° x 22° (f = 12.7 mm) (0.5 in) or 18° x 14° (f = 20 mm) (0.79 in) or 53° x 38° (f = 7.7 mm) (0.30 in) or 80° x 54° (f = 5.7 mm) (0.22 in)	33° x 25° (f = 18.7 mm) (0.74 in) or 15° x 11° (f = 42 mm) (1.65 in) or 60° x 45° (f = 10.5 mm) (0.41 in) or 90° x 64° (f = 7.7 mm) (0.30 in)
40 mK with 33°, 60° and 90° FOV 60 mK with 15° FOV	80 mK	150 mK 175 mK with 18° FOV	80 mK with 33°, 60°, 90° FOV 120 mK with 15° FOV
±2 °C (±3.6 °F) or ±2 %, whichever is greater ±0.05 % / K ²⁾	±2 °C (±3.6 °F) or ±2 %, whichever is greater ±0.05 % / K ²⁾	±2 °C (±3.6 °F) or ±2 %, whichever is greater -	±2 °C (±3.6 °F) or ±2 %, whichever is greater -
USB 2.0 / optional USB to GigE (PoE) Interface	USB 2.0 / optional USB to GigE (PoE) Interface	USB 2.0 / optional USB to GigE (PoE) Interface	USB 2.0 / optional USB to GigE (PoE) Interface
1x 0 – 10 V input, 1x digital input (max. 24 V), 1x 0 – 10 V output	1x 0 – 10 V input, 1x digital input (max. 24 V), 1x 0 – 10 V output	1x 0 – 10 V input, 1x digital input (max. 24 V), 1x 0 – 10 V output	1x 0 – 10 V input, 1x digital input (max. 24 V), 1x 0 – 10 V output
2x 0 – 10 V input, 1x digital input (max. 24 V), 3x 0 /4– 20 mA output, 3x relays (0 – 30 V / 400 mA), 1x fail-safe-relay	2x 0 – 10 V input, 1x digital input (max. 24 V), 3x 0 /4– 20 mA output, 3x relays (0 – 30 V / 400 mA), 1x fail-safe-relay	2x 0 – 10 V input, 1x digital input (max. 24 V), 3x 0 /4– 20 mA output, 3x relays (0 – 30 V / 400 mA), 1x fail-safe-relay	2x 0 – 10 V input, 1x digital input (max. 24 V), 3x 0 /4– 20 mA output, 3x relays (0 – 30 V / 400 mA), 1x fail-safe-relay
0 ... 50 °C (32 ... 122 °F)	0 ... 50 °C (32 ... 122 °F)	0 ... 70 °C (32 ... 158 °F)	0 ... 50 °C (32 ... 122 °F)
- 40 ... 85 °C (-40 ... 185 °F)	- 40 ... 70 °C (-40 ... 158 °F)	- 40 ... 85 °C (-40 ... 185 °F)	- 40 ... 85 °C (-40 ... 185 °F)
10 – 95 %, non-condensing	10 – 95 %, non-condensing	10 – 95 %, non-condensing	10 – 95 %, non-condensing
46 x 56 x 76 – 100 mm (1.81 x 2.20 x 2.99 - 3.93 in); (depending on lens and focus position) / IP 67 (NEMA 4)	46 x 56 x 119 – 126 mm (1.81 x 2.20 x 4.69 - 4.96 in); (depending on focus position) / IP 67 (NEMA 4)	46 x 56 x 68 – 77 mm (1.81 x 2.20 x 2.68 - 3.03 in); (depending on lens and focus position) / IP 67 (NEMA 4)	46 x 56 x 76 – 100 mm (1.81 x 2.20 x 2.99 - 3.93 in); (depending on lens and focus position) / IP 67 (NEMA 4)
269 - 340 g, (9.49 - 11.99 oz) depending on lens	370 g, (13.05 oz), incl. lens	237 - 251 g, (8.36 - 8.85 oz) depending on lens	269 - 340 g, (9.49 - 11.99 oz) depending on lens
IEC 60068-2	IEC 60068-2	IEC 60068-2	IEC 60068-2
1/4 - 20 UNC	1/4 - 20 UNC	1/4 - 20 UNC	1/4 - 20 UNC
via USB	via USB	via USB	via USB
<ul style="list-style-type: none"> • USB camera with 1 lens • USB cable (1 m [3.3 ft]) • Table tripod • PIF cable with terminal block (1 m [3.3 ft]) • Manual • Rugged outdoor case • Software package optris PIX Connect 	<ul style="list-style-type: none"> • USB camera with lens kit (standard lens [PI 640i: O33], microscope lens [MO44]) • Microscope stand • Standard USB cable (1 m [3.3 ft]) • Standard-PIF • Manual • Rugged outdoor case • Software package optris PIX Connect 	<ul style="list-style-type: none"> • USB camera with 1 lens • USB cable (1 m [3.3 ft]) • Table tripod • PIF cable with terminal block (1 m [3.3 ft]) • Manual • Rugged outdoor case • Software package optris PIX Connect 	<ul style="list-style-type: none"> • USB camera with 1 lens • USB cable (1 m [3.3 ft]) • Table tripod • PIF cable with terminal block (1 m [3.3 ft]) • Manual • Rugged outdoor case • Software package optris PIX Connect

1) Accuracy effective starting at 150 °C (302 °F)

2) For T_{Amb} 10 °C ... 50 °C (10 °F ... 122 °F) and $T_{Obj} \leq 500$ °C (932 °F); otherwise: ± 0.1 K/K or 0.1%/K (whichever is greater)

3) For further details see operator's manual

optris PI series – Precision Line

Infrared cameras

with high resolution for fast online applications and exchangeable lenses, including line scan function





PI series Precision Line

The optris infrared cameras of the PI Precision Line offer imaging infrared temperature measurement devices for numerous industrial applications. From all-round talents like the optris PI 400i / 450i to high resolution VGA cameras (optris PI 640i) and special imagers for metal as well as glass applications and even microscope images, we meet your every expectation.

Infrared cameras
PI series



Basic model		PI 400i / PI 450i
Type		IR
Detector		FPA, uncooled (17 µm pitch)
Optical resolution		382 x 288 pixels
Spectral range		8 – 14 µm
Temperature ranges		-20 ... 100 °C (-4 ... 212 °F) 0 ... 250 °C (32 ... 482 °F) (20)150 ... 900 °C (302 ... 1652 °F) ¹⁾ 200 ... 1500 °C (392 ... 2732 °F) (option)
Frame rate		80 Hz / switchable to 27 Hz
Optics (FOV)		18° x 14° / f = 20 mm (f = 0.79 in) or 29° x 22° / f = 12.7 mm (f = 0.5 in) or 53° x 38° / f = 7.7 mm (f = 0.30 in) or 80° x 54° / f = 5.7 mm (f = 0.22 in)
Thermal sensitivity (NETD)		PI 400i: 75 mK with 29°, 53°, 80° FOV PI 450i: 40 mK with 29°, 53°, 80° FOV optics mentioned above: F = 0.9 PI 400i: 0.1 K with 18° FOV / F = 1.1 PI 450i: 60 mK with 18° FOV / F = 1.1
System accuracy (at T _{Amb} = 23 ± 5 °C [73.4 ± 41 °F])		± 2 °C (± 3.6 °F) or ± 2 %, whichever is greater
Temperature coefficient		± 0.05 % / K ²⁾
PC interfaces		USB 2.0 / optional USB to GigE (PoE) Interface
Process interface (PIF)	Standard PIF	1x 0 – 10 V input, 1x digital input (max. 24 V), 1x 0 – 10 V output
	Industrial PIF (optional)	2x 0 – 10 V input, 1x digital input (max. 24 V), 3x 0 / 4– 20 mA output, 3x relays (0 – 30 V / 400 mA), 1x fail-safe-relay
Ambient temperature (T _{Amb})		PI 400i: 0 ... 50 °C (32 ... 122 °F) / PI 450i: 0 ... 70 °C (32 ... 158 °F)
Storage temperature		PI 400i: - 40 ... 70 °C (-40 ... 158 °F) PI 450i: - 40 ... 85 °C (-40 ... 185 °F)
Relative Humidity		10 – 95 %, non-condensing
Size / class		46 x 56 x 68 – 77 mm (1.81 x 2.20 x 2.68 - 3.03 in); (depending on lens and focus position) / IP 67 (NEMA 4)
Weight		237 - 251 g, (8.36 - 8.85 oz) depending on lens
Shock / Vibration ³⁾		IEC 60068-2
Tripod mount		1/4 - 20 UNC
Power supply		via USB
Scope of supply (standard)		<ul style="list-style-type: none"> • USB camera with 1 lens • USB cable (1 m [3.3 ft]) • Table tripod • PIF cable with terminal block (1 m [3.3 ft]) • Manual • Aluminum case (PI 400i) • Rugged outdoor case (PI 450i) • Software package optris PIX Connect

Infrared cameras PI series				
Basic model		PI 05M	PI 08M	PI 1M
Type		IR	IR	IR
Detector	CMOS (15 µm pitch)		CMOS (15 µm pitch)	
Optical resolution	764 x 480 pixels @ 32 Hz 382 x 288 pixels @ 80 Hz (switchable to 27 Hz) 72 x 56 pixels @ 1 kHz 764 x 8 pixels @ 1 kHz (fast line scan mode)		764 x 480 pixels @ 32 Hz 382 x 288 pixels @ 80 Hz (switchable to 27 Hz) 72 x 56 pixels @ 1 kHz 764 x 8 pixels @ 1 kHz (fast line scan mode)	
Spectral range	500 – 540 nm		780 – 820 nm	
Temperature range	900 ... 2450 °C (1652 ... 4442 °F) (27 Hz mode) 950 ... 2450 °C (1742 ... 4442 °F) (32 / 80 Hz mode) 1100 ... 2450 °C (2012 ... 4442 °F) (1 kHz mode)		575 ... 1900 °C (1067 ... 3452 °F) (27 Hz mode) 625 ... 1900 °C (1157 ... 3452 °F) (32 / 80 Hz mode) 750 ... 1900 °C (1382 ... 3452 °F) (1 kHz mode)	
Frame rate	Up to 1 kHz / 1 ms real time analog output (0 - 10 V) of 8 x 8 pixels (freely selectable)		Up to 1 kHz / 1 ms real time analog output (0 - 10 V) of 8 x 8 pixels (freely selectable)	
Optics (FOV)	FOV@ 764 x 480 px: 26° x 16° (f = 25 mm [0.98 in])	FOV@ 382 x 288 px: 13° x 10° (f = 25 mm [0.98 in])	FOV@ 764 x 480 px: 39° x 25° (f = 16 mm [0.63 in]) 26° x 16° (f = 25 mm [0.98 in])	FOV@ 382 x 288 px: 20° x 15° (f = 16 mm [0.63 in]) 13° x 10° (f = 25 mm [0.98 in])
Thermal sensitivity NETD²⁾	< 2 K (< 1400 °C [2552 °F]) < 4 K (< 2100 °C [3812 °F])		< 2 K (< 1000 °C [1832 °F]) < 4 K (< 1600 °C [2912 °F])	
System accuracy (at T _{Amb} = 23 ± 5 °C [73.4 ± 41 °F])	For object temperature < 2000 °C [3632 °F]: ±1 % of reading for 27/32/80 Hz ±1.5 % of reading for 1 kHz For object temperature > 2000 °C [3632 °F]: ±2 % of reading for 27/32/80 Hz ±2.5 % of reading for 1 kHz		For object temperature < 1500 °C [2732 °F]: ±1 % of reading for 27/32/80 Hz ±1.5 % of reading for 1 kHz For object temperature > 1500 °C [2732 °F]: ±2 % of reading for 27/32/80 Hz ±2.5 % of reading for 1 kHz	
PC interfaces	USB 2.0 / optional USB to GigE (PoE) interface		USB 2.0 / optional USB to GigE (PoE) interface	
Process Interface (PIF)	Standard PIF 1x 0 – 10 V input, 1x digital input (max. 24 V), 1x 0 – 10 V output	Industrial PIF (optional) 2x 0 – 10 V inputs, 1x digital input (max. 24 V), 3x 0/4-20 mA outputs, 3x relays (0 – 30 V/ 400 mA), 1x fail-safe relay	1x 0 – 10 V input, 1x digital input (max. 24 V), 1x 0 – 10 V output	2x 0 – 10 V inputs, 1x digital input (max. 24 V), 3x 0/4-20 mA outputs, 3x relays (0 – 30 V/ 400 mA), 1x fail-safe relay
Ambient temperature (T_{Amb})³⁾	5 ... 50 °C (41 ... 122 °F)		5 ... 50 °C (41 ... 122 °F)	
Storage temperature	– 40 ... 70 °C (– 40 ... 158 °F)		– 40 ... 70 °C (– 40 ... 158 °F)	
Relative Humidity	10–95 %, non-condensing		10–95 %, non-condensing	
Size / class	46 x 56 x 88 – 129 mm (1.81 x 2.20 x 3.46 - 5.08 in) with protection tube (depending on lens and focus position) / IP 67 (NEMA 4)		46 x 56 x 88 – 129 mm (1.81 x 2.20 x 3.46 - 5.08 in) with protection tube (depending on lens and focus position) / IP 67 (NEMA 4)	
Weight	245 - 311 g (8.64 - 10.97 oz), depending on lens		245 - 311 g (8.64 - 10.97 oz), depending on lens	
Shock / Vibration⁴⁾	IEC 60068-2		IEC 60068-2	
Tripod mount	1/4- 20 UNC		1/4- 20 UNC	
Power supply	via USB		via USB	
Scope of supply (standard)	<ul style="list-style-type: none"> • USB camera with 1 lens • Lens tube incl. protective window • USB cable (1 m [3.3 ft]) • Table tripod • PIF cable with terminal block (1 m [3.3 ft]) • Software package optris PIX Connect • Manual • Aluminum case • Optional: CoolingJacket, HT cable 		<ul style="list-style-type: none"> • USB camera with 1 lens • Lens tube incl. protective window • USB cable (1 m [3.3 ft]) • Table tripod • PIF cable with terminal block (1 m [3.3 ft]) • Software package optris PIX Connect • Manual • Aluminum case • Optional: CoolingJacket, HT cable 	

¹⁾ Accuracy effective starting at ±75 °C (167 °F) with optics (f = 50 mm [1.95 in] and f = 75 mm [2.95 in]) ²⁾ Specified NETD value applies to all frequencies

Glass inspection system for process control in glass tempering machines

New



With the new glass inspection system, temperature differences during glass hardening processes can be quickly detected, thus avoiding rejects and providing automatic quality monitoring.

The Top Down GIS 640 R system with temperature referencing by means of a sensor from below as well as automatic emissivity correction for standard and low-E glasses was specially developed for process control in glass tempering machines.



Measurement principle

A variety of optics with different field of views allows an optimal mounting of the camera at a larger distance (no cooling needed) and avoids influences by the angle dependent emissivity.

Software PIX Connect

Comprehensive IR camera software without licensing restrictions and with intuitive user interface.

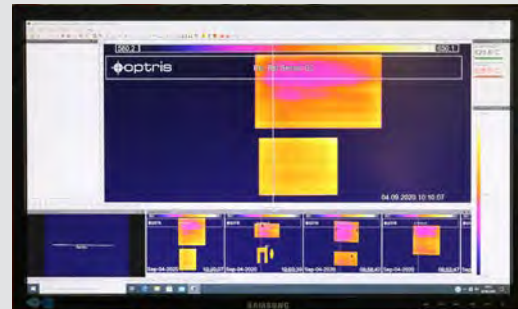

Monitoring temperatures of glass sheets

Positioning of IR camera and reference pyrometer in a Top-Down Glass Inspection System.

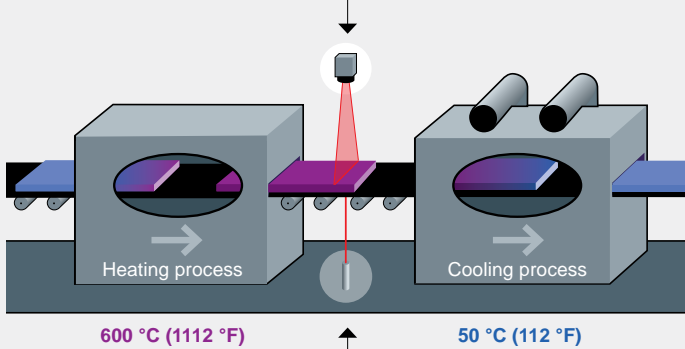

Important specifications

- Top down system with additional reference pyrometer from underneath for automatic emissivity correction
- Digitally controlled lens protection system (DCLP) avoids extra air purging
- Glass area calculation
- Pre-assembled system for easy installation on glasstempering furnaces
- Automatic scan line adjustment – insensitive to distortions

CoolingJacket Advanced

part number: **ACPICJA**

Features

- Operation at ambient temperatures up to 315 °C (599 °F)
- Air/ water cooling with integrated air purging and optional protective windows
- Modular concept for easy installation of different devices and optics
- Trouble-free sensor disassembling on site with quick release chassis
- Integration of additional components like PI NetBox, USB Server Gigabit 2.0 and Industrial Process Interface (PIF) in extended version



Laminar air purge

part number: **ACCJAAPLS**

Features

- Protection for rugged environments
- Air and water cooling, flexible laminar air stream for protection from dirt and dust
- Easy maintenance due to folding mechanism
- Focussable from the outside once installed
- Protection window for mechanical protection integrated
- Also available as line scanner version



Connection options

Industrial Process Interface (PIF)

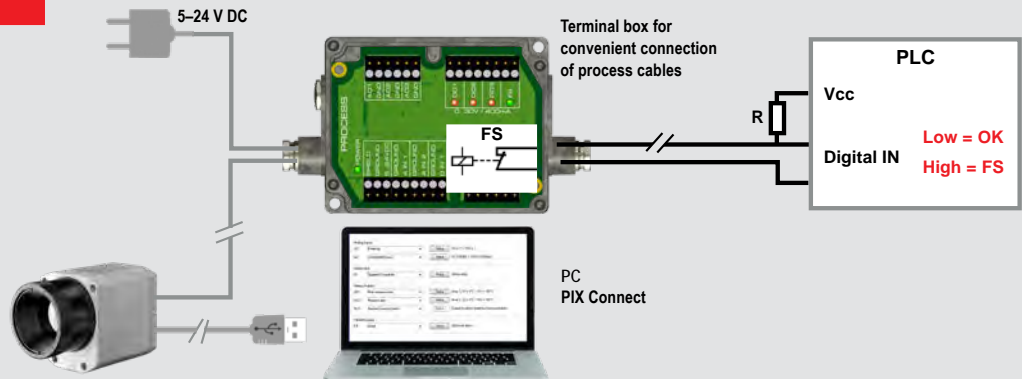

PI NetBox

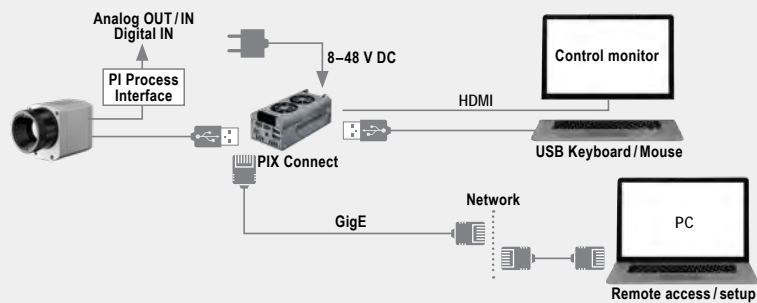

USB Server Gigabit 2.0

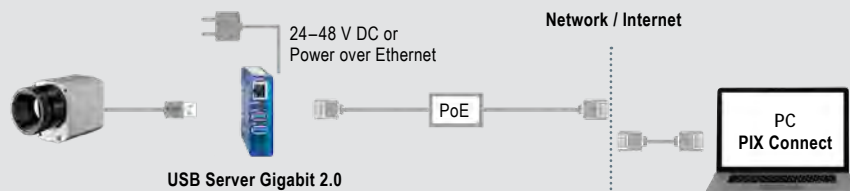

CoolingJacket Advanced

part number: **ACPICJA**

Features

- Operation at ambient temperatures up to 315 °C (599 °F)
- Air/ water cooling with integrated air purging and optional protective windows
- Modular concept for easy installation of different devices and optics
- Trouble-free sensor disassembling on site with quick release chassis
- Integration of additional components like PI NetBox, USB Server Gigabit 2.0 and Industrial Process Interface (PIF) in extended version



Laminar air purge

part number: **ACCJAAPLS**

Features

- Protection for rugged environments
- Air and water cooling, flexible laminar air stream for protection from dirt and dust
- Easy maintenance due to folding mechanism
- Focussable from the outside once installed
- Protection window for mechanical protection integrated
- Also available as line scanner version



Connection options

Industrial Process Interface (PIF)

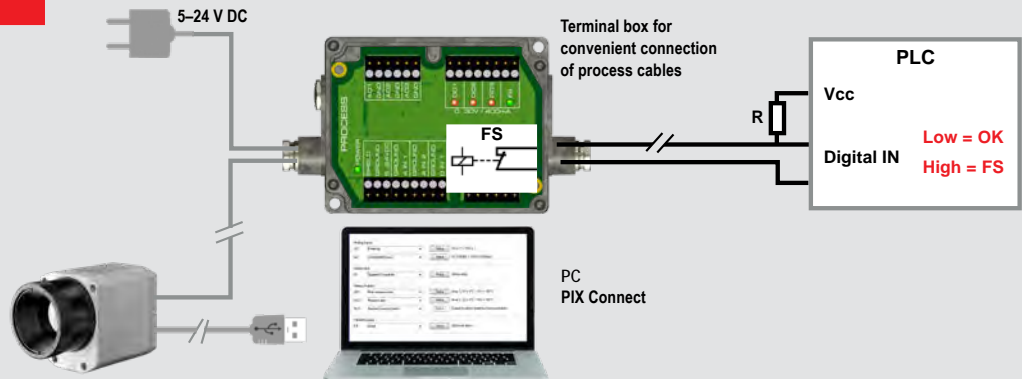

PI NetBox

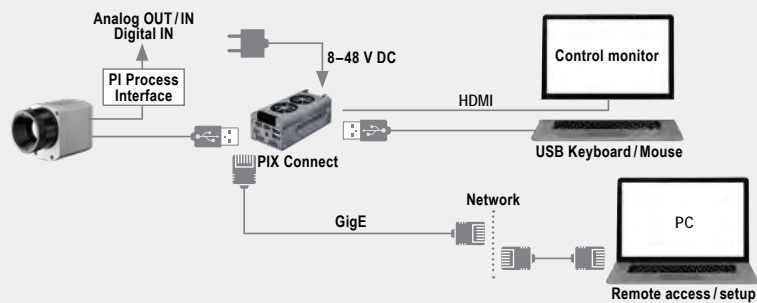

USB Server Gigabit 2.0

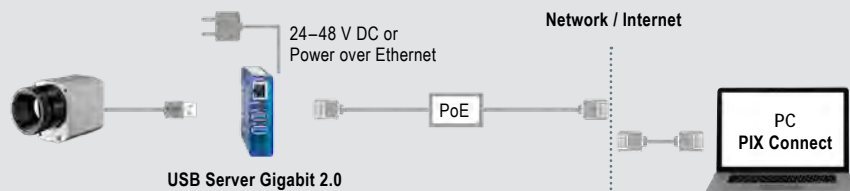

Software IR cameras

PIX Connect Comprehensive IR camera software

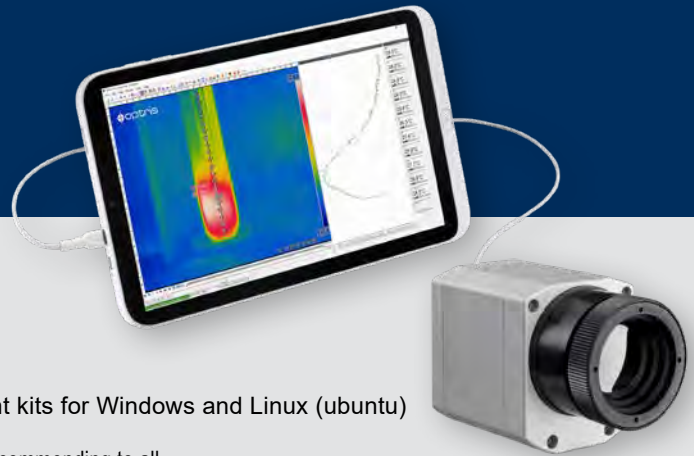

- No licensing restrictions
- Modern software with intuitive user interface
- Display of numerous images in different windows
- Extensive license-free analysis and two software development kits for Windows and Linux (ubuntu)

The **HummingBoard Edge computer** from SolidRun is a hardware we are recommending to all customers who want to integrate our PI and Xi imagers in their Linux based software by using our Direct SDK.

High degree of individualization for customer-specific imaging

- Various layout options for individual customization (window arrangement, toolbar)
- Temperature display in °C or °F
- Choice of individual measurement parameters tailored to the respective application

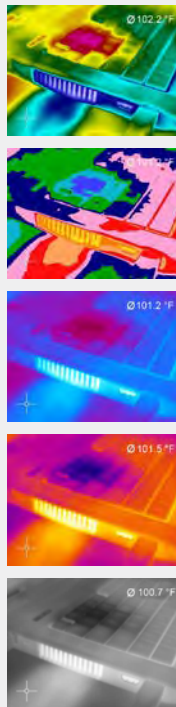

Detailed online and offline data analysis

- Detailed analysis with the help of measurement areas, automatic hot / cold spot search
- Logical linking of temperature information (measurement areas discrepancy, image subtraction)
- Slow-motion replay of radiometric datasets and analysis even without camera
- Editing of sequences, e.g. cut and save individual images
- Various color palettes to highlight thermal contrasts
- Adjustable signal processing (Max, Min, Average)

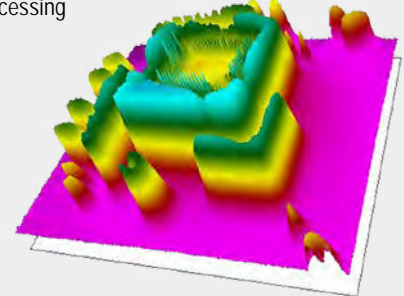

Automatic process control and quality control

- Individual setting of alarm thresholds depending on the process
- External communication of software via COM-ports, DLL
- Adjustment of thermal image via reference values
- Definition of visual or acoustic alarms and analog data output

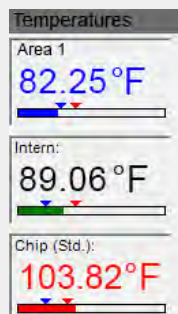

Video recording and snapshot function

- Manually or triggered data gathering
- Radiometric video sequences (*.ravi)
- Radiometric snapshots (*.tiff, *.csv for analysis in Excel)

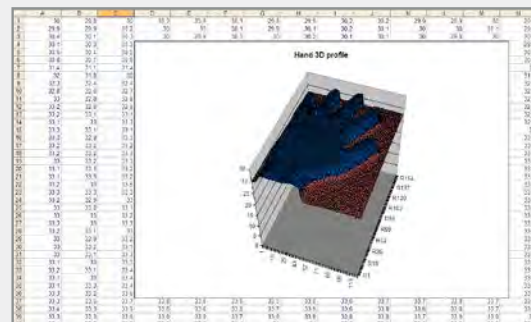

IRmobile

The setting tool for all IR cameras



Infrared camera features

- Live IR image with automatic hot and cold spot search
- Adjustable camera features like temperature measuring range, frame rate and selectable color palettes
- Changing the temperature unit: Celsius or Fahrenheit
- Creating snapshots
- Integrated simulator

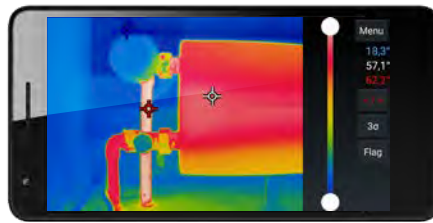
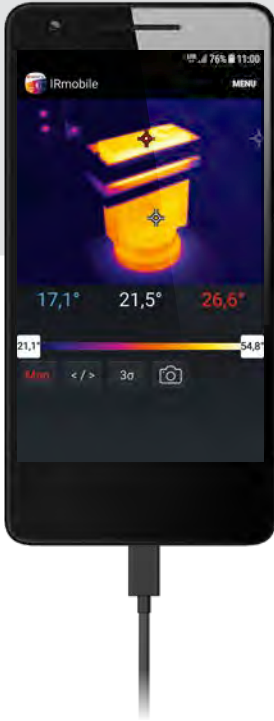

Supported for

- PI and Xi series and all pyrometers
- For android devices from version 5.0 or higher with micro-USB or USB-C connectors that support USB OTG



Optris calculator

Combines the measuring spot size calculator of the IR pyrometers and the optics calculator of the IR cameras

The measuring spot size of the respective device is calculated for each distance



Pyrometers

- The spot size calculator determines the exact spot size for all sensor/optics combinations for any entered distance
- For reliable measurements

IR cameras

- Based on camera / lens combination and the distance to the object, the measuring field dimensions and pixel size are calculated precisely
- Ensures an optimal positioning of the camera and the avoidance of measuring errors

Features

- Calculates for each distance the measuring spot size of the respective device
- Always the current software and features through regular updates



Supported for

- All android devices (5.0 or higher)

