

C-370

REED INSTRUMENTS

RTD Thermometer



Instruction Manual

Table of Contents

Introduction	3
Product Quality.....	3
Safety	3
Features.....	3
Specifications	4-5
<i>Range Specifications</i>	4
<i>Temperature Coefficient</i>	5
<i>RTD Probe Accuracy Specifications</i>	5
Instrument Description	6
Display Description	7
Operating Instructions.....	8-13
<i>Connecting the Pt100 RTD Probe (TP-R01)</i>	8
<i>Connector Configuration</i>	8
<i>Powering the Meter</i>	8
<i>Selecting Temperature Units</i>	9
<i>Taking Measurements</i>	9
<i>Data Hold</i>	9
<i>Backlight</i>	9
<i>Relative Function</i>	10
<i>MAX/MIN/AVG Function</i>	10
<i>Auto Power Off</i>	10-11
<i>Pt Type Selection</i>	11
<i>0°C Calibration</i>	12
<i>Reset Calibration Value to Factory Settings</i>	12-13
Battery Replacement.....	13
Applications.....	14
Accessories and Replacement Parts	14
Product Care	14
Product Warranty	14
Product Disposal and Recycling	15
Product Support.....	15

Introduction

Thank you for purchasing your REED C-370 RTD Thermometer. Please read the following instructions carefully before using your instrument. By following the steps outlined in this manual your meter will provide years of reliable service.

Product Quality

This product has been manufactured in an ISO9001 facility and has been calibrated during the manufacturing process to meet the stated product specifications. If a certificate of calibration is required please contact the nearest authorized REED distributor or authorized Service Center. Please note an additional fee for this service will apply.

Safety

Never attempt to repair or modify your instrument. Dismantling your product, other than for the purpose of replacing batteries, may cause damage that will not be covered under the manufacturer's warranty. Servicing should only be provided by an authorized service center.

Features

- Designed to meet food service standards
- Quick responding, high accuracy
- Large, easy-to-read backlit LCD display
- User selectable °C, °F
- Min/Max/Avg functions
- Relative mode and Data hold
- IP67 rated waterproof housing
- Low battery indicator and auto shut off

Specifications

Measuring Range:	-148 to 572°F (-100 to 300°C)
Resolution:	0.1°F/°C
Type:	Single Input, RTD
Response Time:	2x/second
Stem Material:	316SS
Display:	3 1/2-digit LCD
Backlit Display:	Yes
Data Hold:	Yes
Min:	Yes
Max:	Yes
Average:	Yes
Relative Mode:	Yes
Auto Shut-off:	Yes (after 30 minutes/off)
Low Battery Indicator:	Yes
Power Supply:	3 x AAA Batteries
Battery Life:	Approx 100 hours (Alkaline)
Product Certifications:	IP67, CE
Operating Temperature:	32 to 104°F (0 to 40°C)
Storage Temperature:	14 to 140°F (-10 to 60°C)
Operating Humidity Range:	10 to 90%
Dimensions:	5.9 x 2.6 x 1.2" (150 x 66 x 31mm)
Weight:	6.2oz (175g)

Range Specifications

Range	Accuracy
-100 ~ 300°C	±(0.1% reading + 0.4°C)
-148 ~ 572°F	±(0.1% reading + 0.8°F)

Note: The basic accuracy specifications does not include the error of the RTD probe, refer to the RTD probe accuracy specifications below for additional details.

continued...

Temperature Coefficient

For ambient temperatures from 0 to 18°C and 28 to 50°C, for each temperature reading below 18°C or above 28°C add the following tolerance into the accuracy specification:

0.01% of reading + 0.03°C (0.01% of reading + 0.06°F)

RTD Probe Accuracy Specifications (TP-R01)

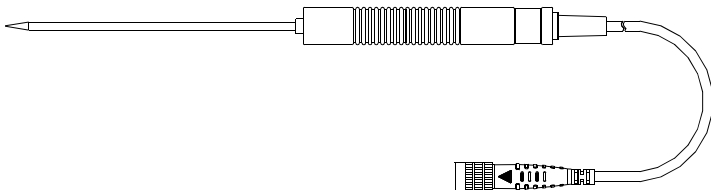

Sensor Type	Platinum resistance thermometer sensor Pt 100 (4 wires)
Accuracy	IEC, class A $\pm 0.27^{\circ}\text{F}$ ($\pm 0.15^{\circ}\text{C}$) ± 0.002 measurement temp.
Measurement Range	-100 to 400°C
Temp. Sensor Dim.	Approximately $\varnothing 3.2\text{mm}$ ($\varnothing 0.125"$)
Temp. Sensor Length	Approximately 120mm (4.72")
Cable Length	Approximately 1100mm (43.3")
Water-Resistant	EN60529:1991, IP67

Instrument Description

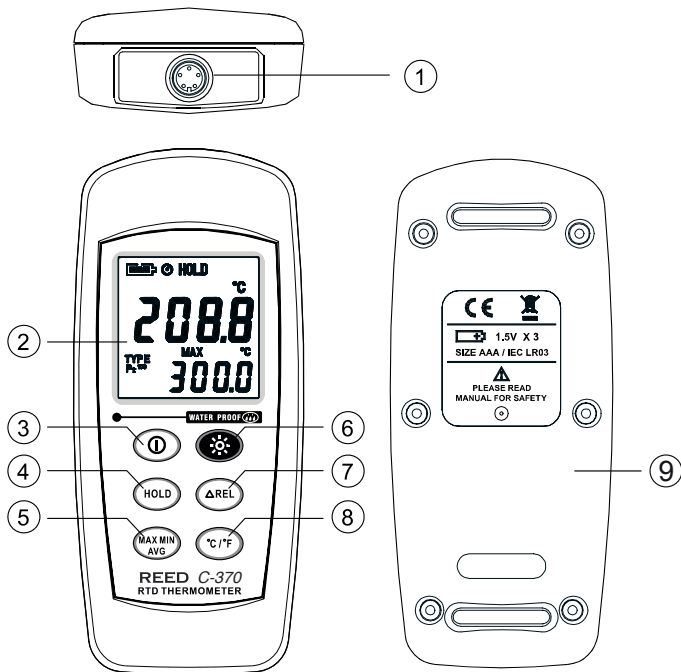

1. PT00 Input Jack
2. LCD Display
3. Power Button
4. HOLD Button
5. MAX/MIN/AVG Button
6. Backlight Button
7. Relative Function Button
8. °C/°F Button
9. Battery Cover

Display Description

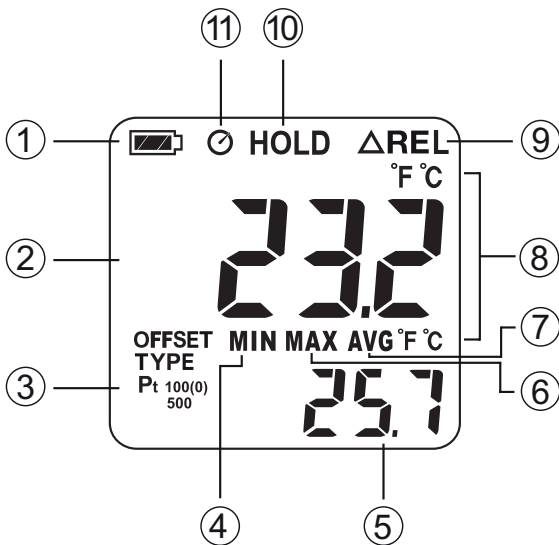

- | | |
|------------------------------------|------------------------------------------|
| 1. Battery Power Indicator | 7. Average Value Indicator |
| 2. Temperature Reading | 8. Temperature Unit of Measure Indicator |
| 3. Platinum Type Indicator | 9. Relative Mode Indicator |
| 4. Minimum Value Indicator | 10. Data Hold Indicator |
| 5. MIN/MAX/AVG Temperature Reading | 11. Auto Power Off Indicator |
| 6. Maximum Value Indicator | |

Operating Instructions

Connecting the Pt100 RTD Probe (TP-R01)

Connect the Pt100 probe to the input jacks located at the top of the meter as indicated below.

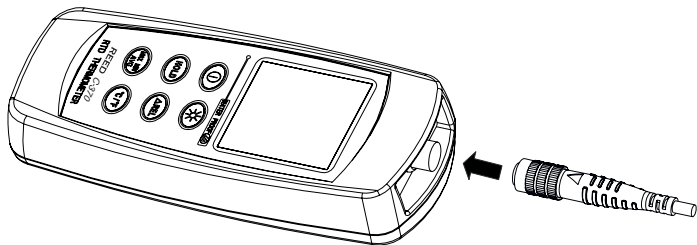

Connector Configuration

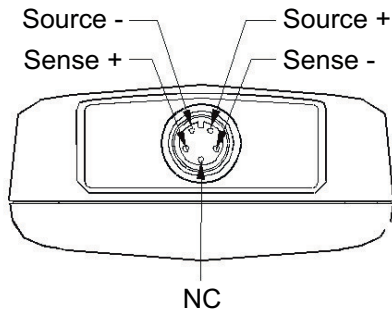

Powering the Meter

To turn the meter on or off, press the POWER button.

continued...

Selecting Temperature Unit of Measure

1. When the meter is first powered on the default scale setting is set to Celsius ($^{\circ}\text{C}$).
2. Press the $^{\circ}\text{C}/^{\circ}\text{F}$ button to toggle between Celsius and Fahrenheit.

Note: The meter will automatically save the selected unit when turned off as the new default.

Taking Measurements

Once the meter has been setup and the Pt100 probe has been connected, place the temperature probe in the area being tested. Give the meter several seconds to stabilize. Read the temperature measurement on the LCD. If " - - - - " appears on the display, either the reading is out of range or the Pt100 probe is not connected or it may be defective.

Note: The temperature sensor is located at the tip of the Pt100 probe. To accurately test internal temperatures, make sure the probe is inserted at a distance of at least 15 times the diameter of the metal sheath as indicated in the diagram.

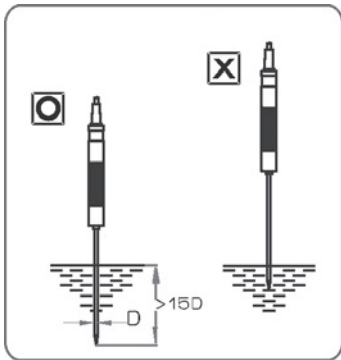

Data Hold

1. Press the **HOLD** button to freeze the current reading on the display.
2. Press the button again to resume normal operation.

Note: When Data Hold is active the **MAX/MIN/AVG**, $^{\circ}\text{C}/^{\circ}\text{F}$ and ΔREL buttons are disabled.

Backlight

Press the **BACKLIGHT** button to turn the LCD Backlight on and off.

Note: The backlight will automatically turn off after 10 seconds.

continued...





Relative Function

1. Press the Δ REL button to store the current measurement.
2. Under this mode, the meter will display the difference between any new measurement and the stored measurement.
3. Press the Δ REL button again to exit Relative function.

MAX/MIN/AVG Function

When the  button is pressed, the meter will enter the MAX/MIN/AVG function. Under this function, the maximum value, minimum value and average values taken during the measurement process will appear on the lower part of the display when selected.

Note: The average value is calculated using the last 8 readings in memory and will update with every new reading.

1. The first value to appear on the display in this function is the Maximum value as indicated by the "MAX" symbol and is updated when a new maximum data value has been taken.
2. Press the  button again and the Minimum value will now appear on the display as indicated by the "MIN" symbol and is updated when a new minimum data value has been taken.
3. Press the  button a third time and the Average value will now appear on the display as indicated by the "AVG" symbol.
4. Press the  button a fourth time and the "MIN", "MAX", "AVG" symbols will blink simultaneously while continuing to update the readings in memory and can be viewed by returning to the appropriate function. While in this function, the meter is displaying the current measurement value only.
5. To exit the MAX/MIN/AVG function, press and hold the  button for two seconds.

Note: When the meter is in MAX/MIN/AVG function, the Δ REL and °C/°F buttons are disabled.

Auto Power Off

1. To preserve battery life, the meter is programmed to turn off after 30 minutes of inactivity.

continued...

- To turn this function off, press and hold the **HOLD** button while powering on the meter.
- Release both buttons simultaneously.
- There will be successive beeps emitted from the meter at start up while the Auto Power Off indicator will not appear on the display, confirming this feature is now disabled.
- If the meter is turned off then back on, the "Auto Power Off" feature will be enabled again.

Turn the power "OFF" before attempting the following SETUP procedures. The setup mode will be cancelled if during the following procedures the **POWER** button is pressed.

Pt Type Selection

While the meter is off, press and hold the **POWER** and BACKLIGHT buttons for 2 seconds to enter the setup function. Press the **HOLD** button to enter the Pt selection function. Press the **MAX** button to toggle between Pt probe type as indicated by Pt100, Pt500 and Pt100. Press the °C/°F button to confirm the selection.

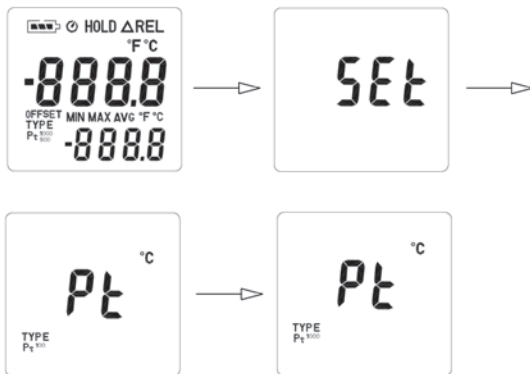

continued...

0°C Calibration



Insert temperature probe into a 0°C standard calibrator unit before calibration. Hold the probe until condition is stabilized before starting calibration.

While the meter is off, press and hold the **POWER** and **BACKLIGHT** buttons for 2 seconds to enter the setup function. Press the **ΔREL** button to enter the calibration function. Enter the Pt selection first. Press the **°C/°F** button to confirm the Pt selection. Press the **ΔREL** button to enter the calibration function. Press the **ΔREL** button to confirm the current calibration value. Press the **°C/°F** button to confirm the selection and resume normal operation.

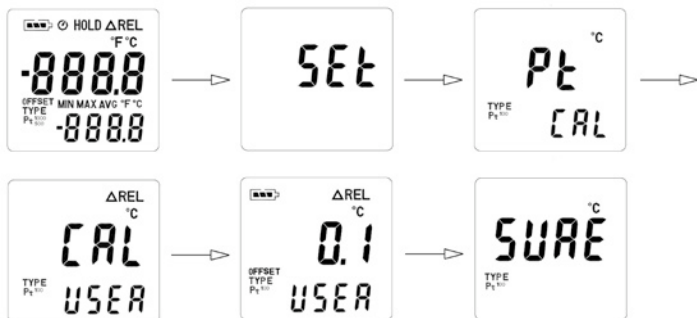

Reset Calibration Value to Factory Settings

While the meter is off, press and hold the **POWER** and **BACKLIGHT** buttons for 2 seconds to enter setup function. Press the **ΔREL** button to enter calibration mode. Enter Pt selection first by pressing the **MAX** button to toggle between Pt probe types. Press the **°C/°F** button to confirm the Pt selection. Press the **BACKLIGHT** button to enter the reset function. Press the **°C/°F** button to reset the calibration value to factory settings. Press the **°C/°F** button to confirm the selection and resume normal operation.

continued...

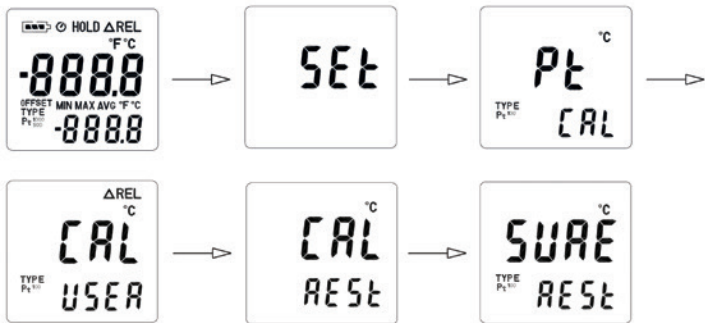

Battery Replacement

When the low battery symbol, , appears on the display, the batteries need to be replaced.

1. Remove all of the screws located on the back of the unit and remove the cover as shown below.
2. Replace the three (3) "AAA" batteries.
3. Properly secure the cover and tighten the screws.

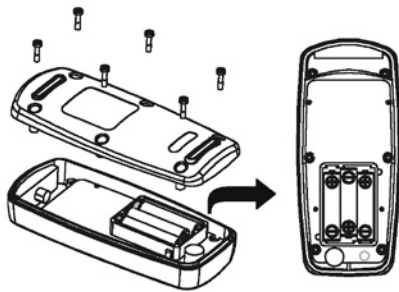

The unit's back cover is fitted with rubber rings. After replacing the batteries, check that the rubber rings are properly placed before reinstalling the back cover. Improper placement of the rubber rings will compromise the unit's water-resistant structure, and possibly result in damage to the meter.

Applications

- Medical
- Pharmaceutical
- Industrial and Commercial Temperature Applications
- R&D and Educational Establishments
- Food Service

Accessories and Replacement Parts

CA-05A Soft Carrying Case

TP-R01 Replacement Pt100 RTD Probe for REED C-370

Don't see your part listed here? For a complete list of all accessories and replacement parts visit your product page on www.reedinstruments.com.

Product Care

To keep your instrument in good working order we recommend the following:

- Store your product in a clean, dry place.
- Change the battery as needed.
- If your instrument isn't being used for a period of one month or longer please remove the battery.
- Clean your product and accessories with biodegradable cleaner. Do not spray the cleaner directly on the instrument. Use on external parts only.

Product Warranty

REED Instruments guarantees this instrument to be free of defects in material or workmanship for a period of one (1) year from date of shipment. During the warranty period, REED Instruments will repair or replace, at no charge, products or parts of a product that proves to be defective because of improper material or workmanship, under normal use and maintenance. REED Instruments total liability is limited to repair or replacement of the product. REED Instruments shall not be liable for damages to goods, property, or persons due to improper use or through attempts to utilize the instrument under conditions which exceed the designed capabilities. In order to begin the warranty service process, please contact us by phone at 1-877-849-2127 or by email at info@reedinstruments.com to discuss the claim and determine the appropriate steps to process the warranty.

Product Disposal and Recycling



Please follow local laws and regulations when disposing or recycling your instrument. Your product contains electronic components and must be disposed of separately from standard waste products.

Product Support

If you have any questions on your product, please contact your authorized REED distributor or REED Instruments Customer Service by phone at 1-877-849-2127 or by email at info@reedinstruments.com.

Please visit www.REEDINSTRUMENTS.com for the most up-to-date manuals, datasheets, product guides and software.

*Product specifications subject to change without notice.
All rights reserved. Any unauthorized copying or reproduction of this manual is strictly prohibited without prior written permission from REED Instruments.*

REED

INSTRUMENTS

TEST & MEASURE WITH CONFIDENCE



CHECK OUT OUR LATEST PRODUCTS!