



Acuvim II Series Power Meter AXM WEB2 User's Manual



ACCUEVERGY

Copyright © 2020 V1.10

This manual may not be altered or reproduced in whole or in part by any means without the expressed written consent of Accuenergy.



V: 1.10 Revised: January 2020

The information contained in this document is believed to be accurate at the time of publication, however, Accuenergy assumes no responsibility for any errors which may appear here and reserves the right to make changes without notice. Please ask the local representative for latest product specifications before ordering.

Please read this manual carefully before installation, operation and maintenance of the Acuvim II series meter. The following symbols in this manual are used to provide warning of danger or risk during the installation and operation of the meters.



Electric Shock Symbol: Carries information about procedures which must be followed to reduce the risk of electric shock and danger to personal health.



Safety Alert Symbol: Carries information about circumstances which if not considered may result in injury or death.

Prior to maintenance and repair, the equipment must be de-energized and grounded. All maintenance work must be performed by qualified, competent accredited professionals who have received formal training and have experience with high voltage and current devices. Accuenergy shall not be responsible or liable for any damages or injuries caused by improper meter installation and/or operation.

V: 1.10 Revised: January 2020



Table of Contents

1. Introduction to Ethernet	4
Introduction to Ethernet.....	4
IPv6.....	4
2. Functional Description of the Ethernet module	4
3. Appearance and Dimensions	5
4. Installation Method	6
5. Definition of RJ45	7
6. Initializing the Ethernet module	8
7. Cable	17
8. Connection Method	17
8.1 Direct Connect to a Computer	17
8.2 Direct Connect to a Router/Switch	21
8.3 Connect through WiFi.....	21
9. Description of Modbus-TCP Protocol	22
9.1 Protocol	22
9.1.1 Data Frame Format.....	22
9.1.2 Modbus Application Header (MBA Header) Field	22
9.1.3 Function Field	23
9.1.4 Data Field	23
9.2 Format of communication	24
9.2.1 Explanation of frame	24
1) Read Status of Relay (Function code 01)	25
2) Read Status of DI (Function Code 02).....	26
3) Read Data (Function Code 03).....	27
4) Control Relay (Function Code05).....	28
5) Preset/Reset Multi-Register (Function Code 16).....	29
10. Web Interface Readings and Parameter Settings	30
10.1 User Access Login	30
10.2 Dashboard	31
10.3 Metering web page	32
10.3.1 Basic Metering.....	32
10.3.2 Power & Energy.....	33
10.3.3 Min/Max	34
10.3.4 THD	35
10.3.5 Harmonics.....	36
10.3.6 Phase Angles.....	37
10.3.7 Sequence.....	37
10.3.8 I/O	38
10.4 Logs	40
10.4.1 Trendlog	41
Realtime.....	41
Energy	42
Data Preview	43
10.4.2 Trendlog Management	44
Clear Logs.....	45

10.4.3 Data Log	46
Deleting Data Logs	46
10.4.4 Alarm Log	47
10.4.5 SOE Log	48
10.4.6 Waveform Log	49
COMTRADE	52
10.5 About	52
10.6 Settings	53
10.6.1 Meter	53
General Setting	53
IO Settings	61
Alarm Settings	67
Custom Read	68
Waveform Settings	70
10.6.2 Communications	72
Network	72
IPv6	78
Email	79
Time/Date	82
Data Log	84
Post Channel	88
Waveform Post	93
AcuCloud	95
BACnet/IP	96
SNMP	98
DNP	99
IEC61850	103
EtherNet/IP	105
Remote Access	105
10.6.3 Management	107
Parameter Reset	107
Reboot Meter & Communications Module	108
Change Password	108
Reset to Factory	109
SSH	109
Debug Diagnostic	109
Diagnostic File	110
10.6.4 Network Diagnostic	111
10.6.5 Module Firmware Update	113
Auto Firmware Update	113
Manual Update	114
Remote Update	116
10.6.6 Meter Firmware Update	118
Manual Update	119
Remote Update	121
10.6.7 Emergency Mode	124
10.6.8 Config Management	125

1. Introduction to Ethernet

The AXM-WEB2 module provides a dual Ethernet and WiFi communication channel for Acuvim II series power meters. Users will be able to use both Ethernet ports and WiFi simultaneously with different networks and data acquisition systems.

This communications module provides users with an industry leading 100ms and 40ms response rate via Modbus TCP that allows users to attain real time updates to key parameters such as voltage, current and power from the Acuvim II Series meter.

Introduction to Ethernet

Ethernet was originally developed by Xerox and then further developed by DEC and Intel. This networking technology uses Carrier Sense Multiple Access with Collision Detection (CSMA/CD) protocol and provides transmission speeds up to 100Mbps.

Ethernet is not a network but more of a standard. It is the most current communication standard Local Area Network(LAN). This standard defines the type of cable that is used and the method of Signal Processing. The AXM-WEB2 module supports two Ethernet channels.

IPv6

The AXM-WEB2 module also supports IPv6 which is the latest version for the internet protocol. The protocol uses 128-bit addressing in comparison to IPv4 which uses 32-bit addressing. The difference for addressing allows for more devices to be connected using IPv6 as opposed to the IPv4 protocol. The protocol is more efficient and provides more secure routing over the internet.

2. Functional Description of the Ethernet module

The AXM-WEB2 module supports a wide range of communication protocols. Some of the more commonly used protocols are briefly explained below.

This module supports the Modbus-TCP protocol. When connected to the Acuvim II series meter, it is a slave device that can only respond to queries. The default value for the Modbus Port is 502. The user defined range is 2000~5999.

The AXM-WEB2 grants users the ability to send emails based on a time interval or when there is a triggered event using the SMTP protocol. It can send mail from encrypted servers and servers that use different SMTP ports.

The AXM-WEB2 protocol supports HTTPS protocol. It is used as an HTTPS server and where the default value of the protocol port is 443. Using the HTTPS protocol, the AXM-WEB2 can send post requests to both HTTP and HTTPS servers.

The following are all the protocols supported by the AXM-WEB2 module:

- Modbus TCP
- IPv6
- RSTP
- BACnet-IP
- SNMP V3
- DNP 3.0 V2
- IEC 61850 2nd Edition
- SMTP, NTP
- HTTP/HTTPS
- FTP
- sFTP
- WiFi WPA, WPA2 Enterprise

3. Appearance and Dimensions

The dimensions in the following diagram are in millimeters.

Dimensions listed in the brackets are inches.

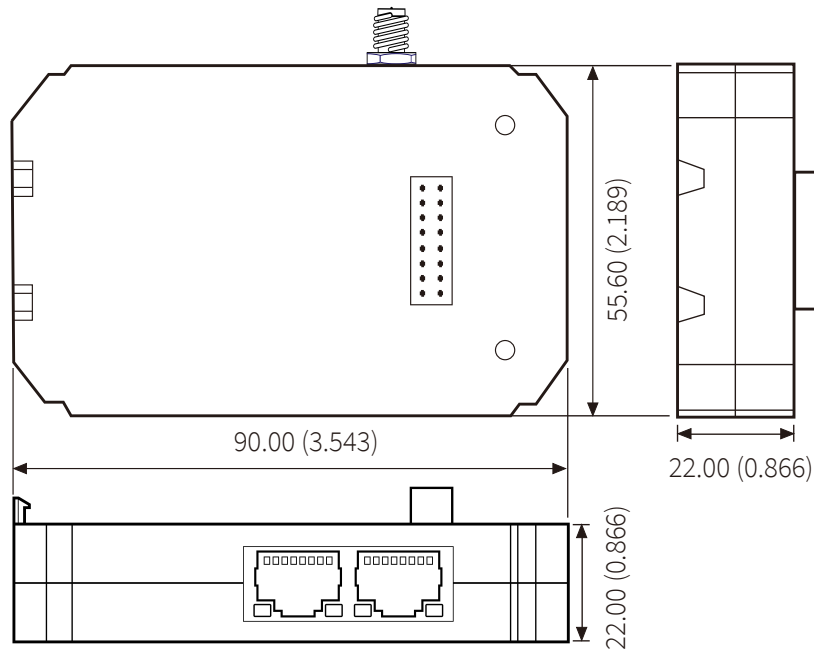

V: 1.10 Revised: January 2020

4. Installation Method

The AXM-WEB2 module is linked to the Acuvim II series meter by a communication plug. Other extended modules such as the IO modules can be linked to the Acuvim II series meter through the AXM-WEB2.

- 1) Remove cover from the back of the Acuvim II series meter which will expose the socket.
- 2) Insert the installation clips to the grooves in the Acuvim II series meter and then press the AXM-WEB2 module lightly to establish a linking between meter and module.
- 3) Tighten the installation screws.

NOTE: Installation with power to the meter is forbidden. The module must be installed/uninstalled while the meter is powered off.

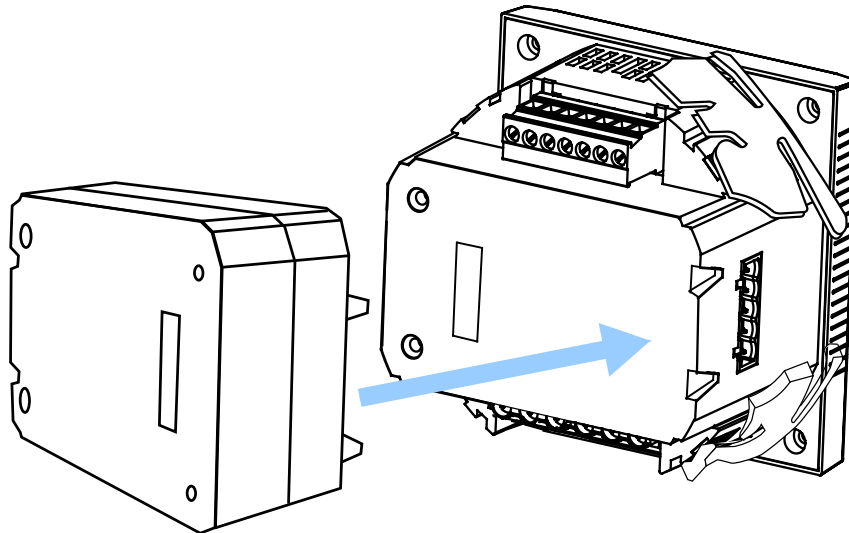

5. Definition of RJ45

The AXM-WEB2 uses two standard RJ45 connectors to access the Ethernet network. The mechanical and electrical characteristics of the connector are consistent with the requirements of IEC 603-7.

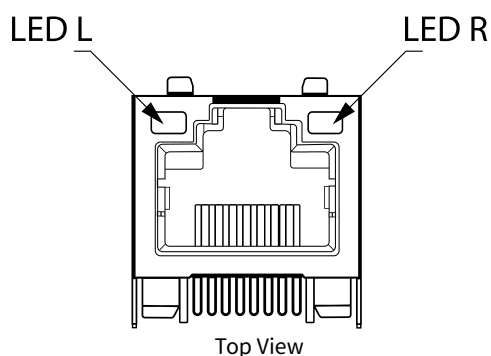

Pin number	Name	Description
1	TX+	Tranceive Data+
2	TX-	Tranceive Data-
3	RX+	Receive Data+
4	n/c	Not connected
5	n/c	Not connected
6	RX-	Receive Data-
7	n/c	Not connected
8	n/c	Not connected

LED_L (Yellow): Displays the speed status. When the LED is on it indicates 100Mbps, while an off LED represents a speed of 10Mbps.

LED_R (Green): Displays the link and activity status. When the LED is on it indicates the link status. When the LED is flashing it indicates that there is activity.

6. Initializing the Ethernet module

The default settings in the Acuvim II series meter are as followed:

Ethernet 1 (Static IP address)

IP Address (192.168.1.254)

Subnet Mask (255.255.255.0)

Gateway (192.168.1.1)

DNS Server 1 (8.8.8.8)

DNS Server 2 (8.8.4.4)

Modbus Port 502

Ethernet 2 (Dynamic IP address)

By default Ethernet 2 is configured for DHCP, meaning the network will dynamically assign its network properties. In order to view the Ethernet 2 IP address from the meters display the Acuvim II meter must be configured to the WEB2 protocol. The following explains how to change the meters protocol settings to work with the WEB2 module:

- Press the 'H' and 'V/A' buttons simultaneously on the Acuvim II series. Release the buttons and the meter will enter the meter selecting mode, as indicated by the flashing 'Meter' cursor.

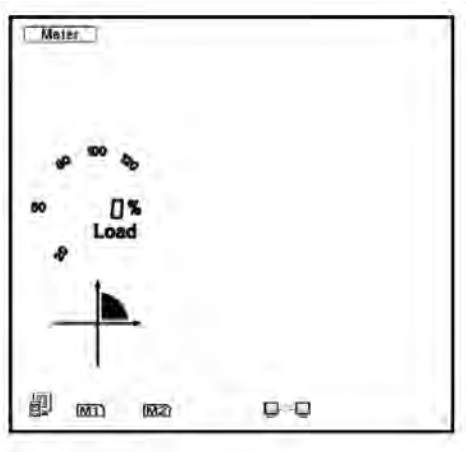

Chapter 6: Initializing the Ethernet module

- Press the 'P' or 'E' button to move the cursor to 'Setting'. Press 'V/A' button to enter the parameter setting mode. The device address page is the first page of the 'Setting' mode. It will show the Modbus address of the meter for a second before prompting for the password of the device.
- You will be required to type in a password in the 'PASSWORD' screen. Leave the password as default '0000' and press 'V/A' to enter the parameter selection Mode.

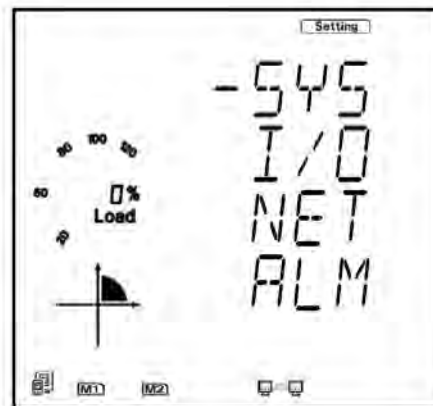

AXM-WEB2 for Acuvim II Series Power Meter

- The cursor will be on 'SYS'. Press 'V/A' on this screen to get to the system settings. This will show screen 'S01 ADDR'.
- Press the 'E' button until you get to 'S34 PROTOCOL 2'. Select the 'WEB2' protocol.
 - Press 'V/A' to modify the setting; the cursor should now flash.
 - Press 'P' or 'E' to select 'WEB2'.
 - Press 'V/A' to confirm the change.



Once the protocol 2 setting of the Acuvim II meter is configured for WEB2, users can now view all necessary settings in the meters NET settings.

Press the 'H' button to exit the system setting, you will be directed to the parameter selection screen.

Press the 'P' or 'E' button to move the cursor to 'NET' and press the 'V/A' button to enter the Ethernet module settings.



Chapter 6: Initializing the Ethernet module

- The first page of the NET Settings will be the N01 DHCP setting. By default this is configured to Manual. Setting this configuration to Auto will allow the router to assign the meter with an IP address, while Manual will allow the user to configure the IP address. Press the 'V/A' button to enter edit mode. Press 'P' or 'E' to change the setting and press 'V/A' to confirm.

NOTE: If the DHCP is selected as Auto, the Ethernet module needs to be rebooted before it can be assigned with the new IP address.



- Press 'P' to get to "N02 IP address" This is the IP address for Ethernet 1 and can be used to access the web interface of the module. Users can configure the IP address if the DHCP is configured to Manual. Press 'V/A' to configure the IP address. The cursor of the first digit will begin to flash. Press the 'H' button to scroll through the digits, press the 'P' or 'E' to change the value of the flashing cursor and press 'V/A' to confirm.



AXM-WEB2 for Acuvim II Series Power Meter

- Press 'P' to get to "N03 Subnet Mask". Press 'V/A' to configure the subnet address. The cursor of the first digit will begin to flash. Press the 'H' button to scroll through the digits, press the 'P' or 'E' to change the value of the flashing cursor and press 'V/A' to confirm.



- Press 'P' to get to "N04 Gateway". Press 'V/A' to configure the gateway IP address. The cursor of the first digit will begin to flash. Press the 'H' button to scroll through the digits, press the 'P' or 'E' to change the value of the flashing cursor and press 'V/A' to confirm.



Chapter 6: Initializing the Ethernet module

- Press 'P' to get to "N05 DNS Primary Server". Press 'V/A' to configure the DNS address. The cursor of the first digit will begin to flash. Press the 'H' button to scroll through the digits, press the 'P' or 'E' to change the value of the flashing cursor and press 'V/A' to confirm. The DNS parameters must be set correctly to use the SMTP, FTP/HTTP Post and AcuCloud functions.

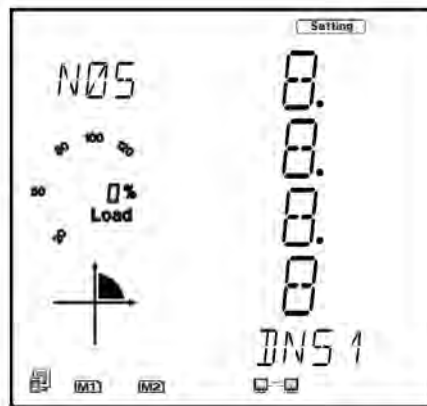

- Press 'P' to get to "N06 DNS Secondary Server". Press 'V/A' to configure the DNS address. The cursor of the first digit will begin to flash. Press the 'H' button to scroll through the digits, press the 'P' or 'E' to change the value of the flashing cursor and press 'V/A' to confirm.



AXM-WEB2 for Acuvim II Series Power Meter

- Press 'P' to get to "N07 Modbus Port". Press 'V/A' to configure the Modbus Port. The cursor of the first digit will begin to flash. Press the 'H' button to scroll through the digits, press the 'P' or 'E' to change the value of the flashing cursor and press 'V/A' to confirm.



- Press 'P' to get to "N08 HTTP Port". Press 'V/A' to configure the HTTP Port. The cursor of the first digit will begin to flash. Press the 'H' button to scroll through the digits, press the 'P' or 'E' to change the value of the flashing cursor and press 'V/A' to confirm.



Chapter 6: Initializing the Ethernet module

- Press 'P' to get to "N09 NET REST". After making any changes to the NET settings, users must reboot the Ethernet module from this page for the settings to take effect. Press 'V/A' to reboot the module, the cursor will begin to flash. Press the 'P' or 'E' button to change the setting to 'Reset' and press 'V/A' to confirm. The cursor will return to 'No' once the module has successfully reset.



- Press 'P' to get to "N10 PASSREST". Press 'V/A' to configure the password reset. The cursor of the first digit will begin to flash. Press the 'P' or 'E' button to change the setting to 'Reset' and press 'V/A' to confirm. The cursor will return to 'No' once successful.

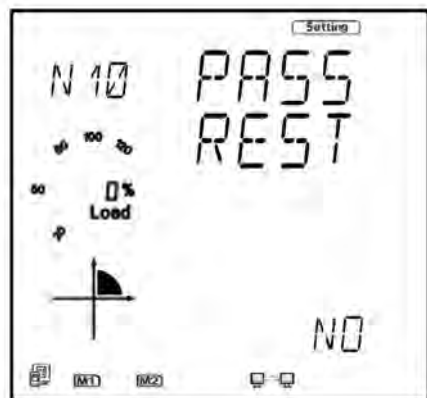

AXM-WEB2 for Acuvim II Series Power Meter

- Press 'P' to get to "N11 WiFi" This is the IP address of WiFi and will be the IP address to access the web interface of the module by using WiFi connection. This IP address cannot be modified from the meters display, it can only be configured on the meters web server.



- Press 'P' to get to 'N12 IP2'. This is the IP address for Ethernet port 2, it is preset as dynamic DHCP. A new IP address will be assigned to it when it is connected to the internet via Ethernet port 2.

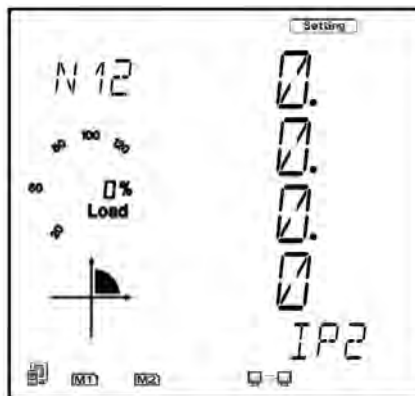

7. Cable

An RJ45 cable is needed to connect the meter to the network.

A shielded twisted pair cable(standard 568A or standard 568B) is recommended as reference to the EIA/TIA standard.

8. Connection Method

8.1 Direct Connect to a Computer

The AXM-WEB2 can be connected to a computer using a crossover cable(standard 568A). The AXM-WEB2 module supports Modbus-TCP and HTTPS Functions for this method of connection.

To connect meter directly to the computer, the computers IP must be within the same subnet as the meters IP address. The following steps outline how to change the computers IP using a computer running the Windows OS::

- Manually connect the meter via Ethernet cable to the computer
- Right click on the connection icon
- Select "Open Network Sharing Center"

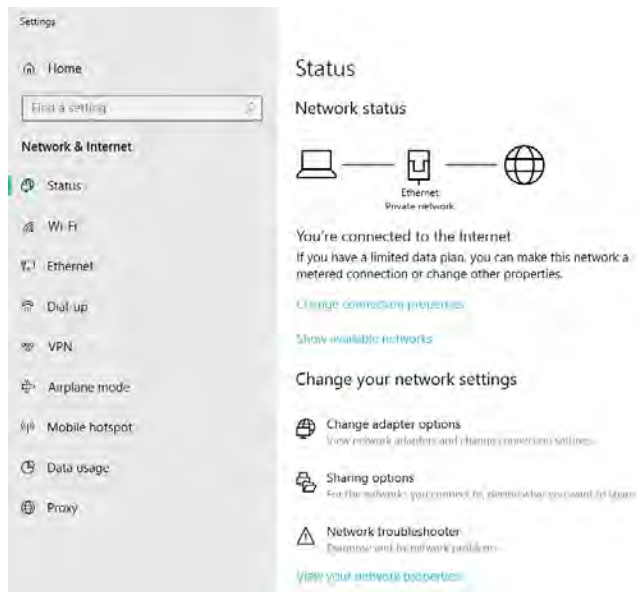

AXM-WEB2 for Acuvim II Series Power Meter

- Click on Change adapter options

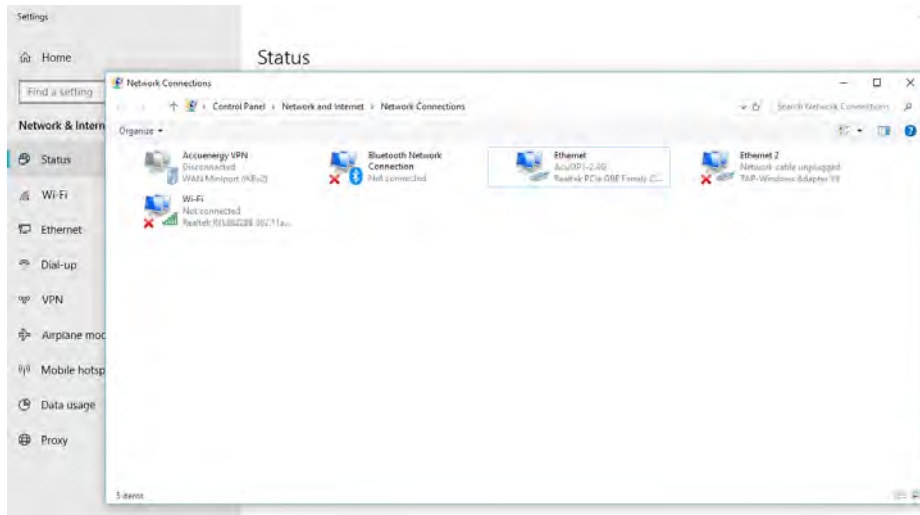

- Once there, right click on the local area connection icon and select properties.

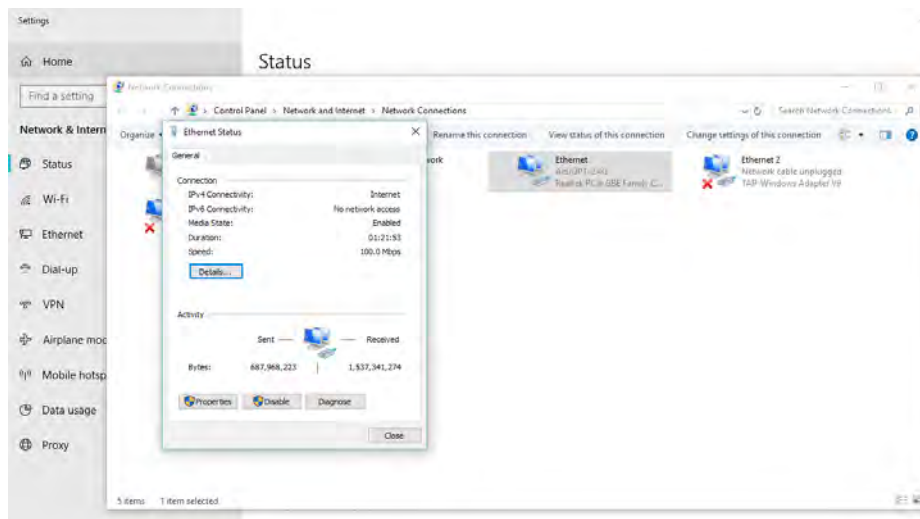

- Select the icon that says Internet Protocol Version 4 TCP/IP

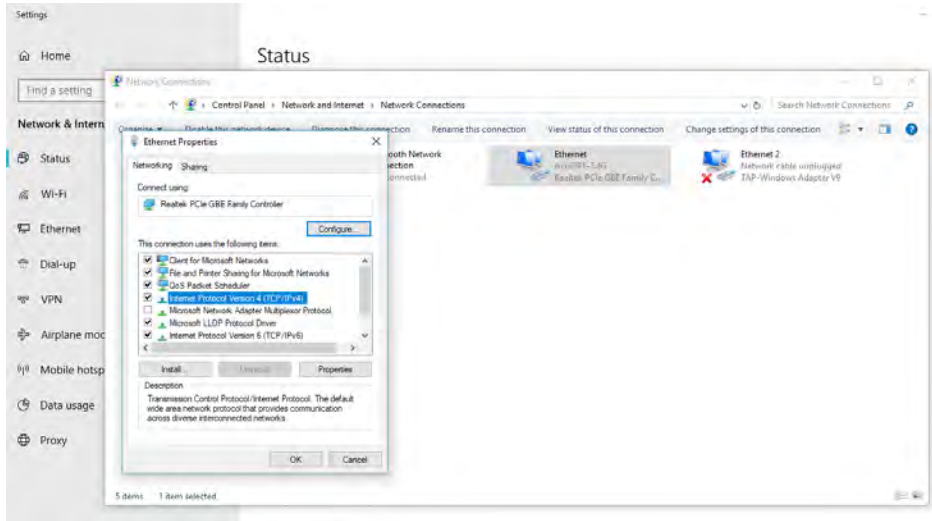

- The Internet Protocol Version 4(TCP/IP) Properties box will pop up

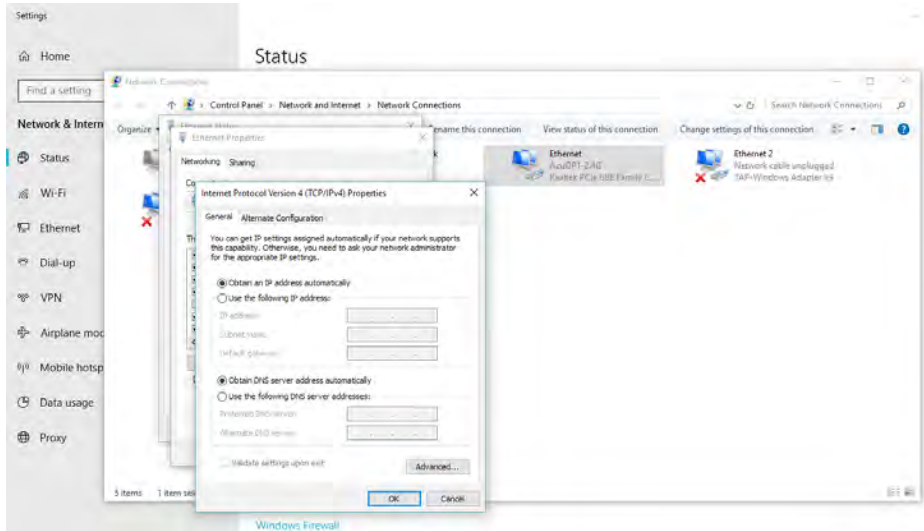

AXM-WEB2 for Acuvim II Series Power Meter

- Click on "Use the following IP address" and enter in an IP number so that meter and computer are in the same local network range. For example, if the meter has IP address of 192.168.1.254, then the computer must be assigned with an IP 192.168.1.xxx, where xxx can be any number but cannot be the same as the value the meter has.

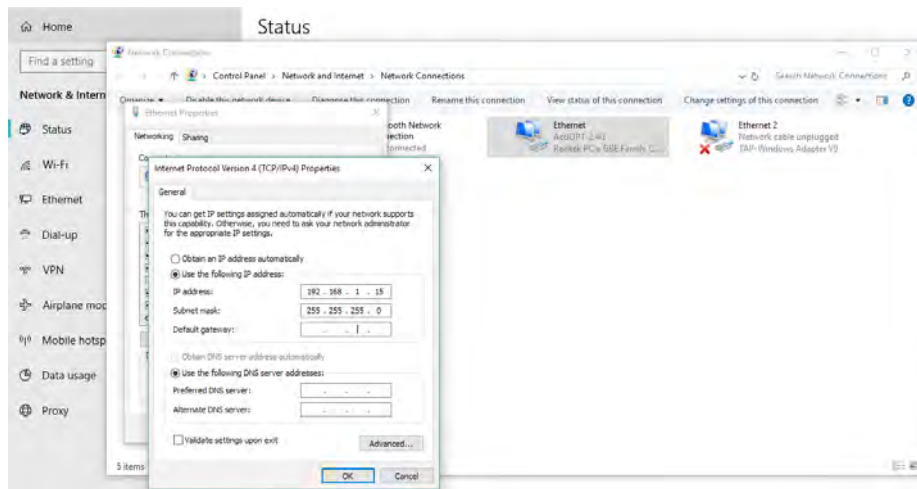

- Once you have entered in the IP address, press the Tab key on your keyboard until you hit the bottom and click OK
- Before selecting the OK button make note of the IP address you have assigned to the meter and then press OK.

NOTE: The meter and computer cannot have the same IP address, they must be different.

8.2 Direct Connect to a Router/Switch

The AXM-WEB2 can be connected to a router or switch using a patch cable. The DHCP can be configured to Auto to have the router assign the meter with an IP address or the DHCP can be configured to Manual to set an IP address and network settings manually.

AXM-WEB 2 has two Ethernet ports, Ethernet 1 is set to have the static DHCP, and Ethernet 2 is set to have the dynamic DHCP. Both of the Ethernet ports have the same functionalities, you can use either of them according to the requirement.

8.3 Connect through WiFi

The AXM-WEB2 can be connected through WiFi network.

By default the AXM-WEB2 will be in Access Point mode with default IP address of 192.168.100.1. Ensure the device connecting to the AXM-WEB2 has DHCP enabled or it should be in the same subnet as the AXM-WEB2. The module will appear in the WiFi network as AXM-WEB2-WIFI-(serial number of module) as the SSID or name of the wireless network. By default, the network key or password will be "accuenergy".

- Once connected to the network, open an internet browser and type in the IP address of the WIFI module: **192.168.100.1**
- Log in at Admin access level, using the default password of **'admin'**.

9. Description of Modbus-TCP Protocol

The Modbus-TCP protocol is used as one of the communication protocols in the AXM-WEB2. The protocol establishes a master and slave connection in Ethernet. The master device(client) first sets up a TCP-IP link with slave device(server). The master device then sends a request to the slave device and the slave device in return sends a response to the master device. Figure below shows how the Modbus-TCP protocol works.

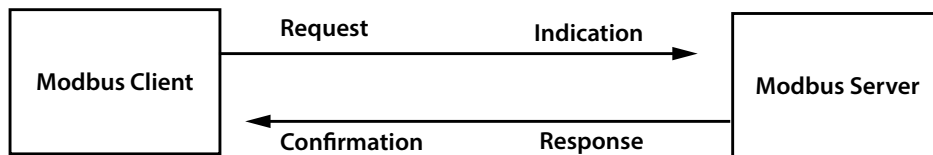

9.1 Protocol

9.1.1 Data Frame Format

MBAP Header	Function	Data
7x8 bits	8-bits	Nx8 bits

9.1.2 Modbus Application Header (MBA Header) Field

Modbus application header field is the start of the data frame, and consists of seven bytes.

Field	Length	Description
Transaction Identifier	2 Bytes	Identification of a Modbus Request/Response transaction
Protocol Identifier	2 Bytes	Modbus Protocol = 0
Length	2 Bytes	Number of following bytes
Unit Identifier	1 Byte	Slave address, in the range of 0-247 decimal

9.1.3 Function Field

The function code field of a message frame contains eight bits. Valid codes are in the range of 1-255. When a message is sent from a client to a server device, the function code field tells the server what kinds of action to perform.

Code	Meaning	Data
01	Read Relay Output Status	Obtain current status of Relay Output
02	Read Digital Input (DI) Status	Obtain current status of Digital Input
03	Read Data	Obtain current binary value in one or more registers
05	Control Single Relay Output	Force Relay to a state of ON or OFF
16	Write Multiple Registers	Place specific value into a series of consecutive multiple registers

9.1.4 Data Field

The data field is constructed using sets of two hexadecimal digits, in the range of 00 to FF. The data field of messages sent from a master to slave contains additional information which the slave must use to take the action defined by the function code. This can include information such as the register addresses, the quantity of registers to query and the count of the actual number of data bytes. For example, if the master requests a slave to read a group of holding registers(function code 03), the data field specifies the starting register and how many registers are to be read.

If the master needs to write data(function code 10 hexadecimal) to a group of registers in the slave, the data field specifies the starting register, how many registers to write, the count of data bytes to follow in the data field and the data to be written into the registers.

9.2 Format of communication

9.2.1 Explanation of frame

Transaction identifier hi	Transaction identifier lo	Protocol identifier hi	Protocol identifier lo	Length hi	Length lo	Unit identifier
0H	00H	00H	00H	00H	06H	01H

Function Code	Data start register hi	Data start register lo	Data # of registers hi	Data # of registers lo
03H	40H	00H	00H	48H

The meaning of each abbreviated field above is:

Transaction identifier hi: High byte of transaction identifier

Transaction identifier lo: Low byte of transaction identifier

Protocol identifier hi: High byte of protocol identifier

Protocol identifier low: Low byte of protocol identifier

Length hi: High byte of length

Length lo: Low byte of length

Unit identifier: Slave address

Fun: Function code

Data start register hi: High byte of starting register address

Data start register lo: Low byte of starting register address

Data #of registers hi: High byte of number of registers

Data #of registers lo: Low byte of number of registers

1) Read Status of Relay (Function code 01)

Function Code 1

This function code is used to read the relay output status in the Acuvim II series meter.

1=On 0=Off

There are 8 relay outputs in the Acuvim II series meter and they start at address 0000H.

The following query is to read 2 relay output status of the Acuvim II series address 1.

Query

Transaction identifier hi	Transaction identifier lo	Protocol identifier hi	Protocol identifier lo	Length hi	Length lo	Unit identifier
00H	00H	00H	00H	00H	06H	01H

Fun	Data start register hi	Data start register lo	Data # of registers hi	Data # of registers lo
01H	00H	00H	00H	02H

Response

The Acuvim II series meter responds back with the MBAP header, function code, quantity of data bytes and the data.

An example of response to read the status of the first 2 relay outputs starting at 0000H is shown below. The status of relay output 1 and 2 is corresponds to the last 2 bits of data.

Relay 1: bit0 Relay 2: bit1

Transaction identifier hi	Transaction identifier lo	Protocol identifier hi	Protocol identifier lo	Length hi	Length lo	Unit identifier
00H	00H	00H	00H	00H	04H	01H

Fun	Byte count	Data
01H	01H	02H

AXM-WEB2 for Acuvim II Series Power Meter

The content of the data is,

7	6	5	4	3	2	1	0
0	0	0	0	0	0	1	0

MSB

LSB

(Relay 1 = OFF, Relay 2 = ON)

2) Read Status of DI (Function Code 02)

Function Code 2

1=On

0=Off

There are 28 DIs in the Acuvim II series meter starting at address 0000H.

The following query is to read 4 DI statuses of AXM-IO1 module with logic address of 1 in the Acuvim II series meter.

Query

Transaction identifier hi	Transaction identifier lo	Protocol identifier hi	Protocol identifier lo	Length hi	Length lo	Unit identifier
00H	00H	00H	00H	00H	06H	01H

Fun	Data start register hi	Data start register lo	Data # of registers hi	Data # of registers lo
02H	00H	00H	00H	04H

Response

The response includes the MBAP header, function code, quantity of data characters and the data.

An example response from the meter to read the status of 4 DIs(DI1=On, DI2=On, DI3=On, DI4=On) is shown below. The status of each corresponds to the last 4 bits of the data.

DI1: bit0		DI2: bit1		DI3: bit2		DI4: bit3	
Transaction identifier hi	Transaction identifier lo	Protocol identifier hi	Protocol identifier lo	Length hi	Length lo	Unit identifier	
00H	00H	00H	00H	00H	04H	01H	

Fun	Byte count	Data
02H	01H	0FH

The content of the data is,

7	6	5	4	3	2	1	0
0	0	0	0	1	1	1	1

MSB

LSB

3) Read Data (Function Code 03)

Function Code 3

Query

This function allows the user to obtain the measurement results of the Acuvim II series meter.

Below is an example to read 6 registers corresponding to the device clock of the meter, starting at 1040H.

Transaction identifier hi	Transaction identifier lo	Protocol identifier hi	Protocol identifier lo	Length hi	Length lo	Unit identifier
00H	00H	00H	00H	00H	06H	01H

Fun	Data start reg hi	Data start reg lo	Data #of reg hi	Data #of reg lo
03H	10H	40H	00H	06H

An example response is provided to read the time (2006-12-18 14:15:20).

Transaction identifier hi	Transaction identifier lo	Protocol identifier hi	Protocol identifier lo	Length hi	Length lo	Unit identifier
00H	00H	00H	00H	00H	0FH	01H

Fun	Byte count	Data1 hi	Data1 lo	Data2 hi	Data2 lo	Data3 hi	Data3 lo	Data4 hi	Data4 lo	Data5 hi	Data5 lo	Data6 hi	Data6 lo
03H	0CH	07H	D6H	00H	0CH	00H	12H	00H	0EH	00H	0FH	00H	14H

4) Control Relay (Function Code05)

Function Code 5

Query

This function code enables the control of a single relay output in the Acuvim II series meter. Any relay output in the Acuvim II series meter can be controlled on or off starting at 0000H.

Sending the data 'FF00H' will set they relay output on and sending '0000H' will turn it off; all other values are illegal and will not affect they relay output status.

The example below is a request to a Acuvim II series meter to turn on relay output 1.

Transaction identifier hi	Transaction identifier lo	Protocol identifier hi	Protocol identifier lo	Length hi	Length lo	Unit identifier
00H	00H	00H	00H	00H	06H	01H

Fun	Data start reg hi	Data start reg lo	Data #of reg hi	Data #of reg lo
05H	00H	00H	FFH	00H

Response

The normal response to the command request is to retransmit the message as received after the relay output status has been altered.

Transaction identifier hi	Transaction identifier lo	Protocol identifier hi	Protocol identifier lo	Length hi	Length lo	Unit identifier
00H	00H	00H	00H	00H	06H	01H

Fun	Data start reg hi	Data start reg lo	Value hi	Value lo
05H	00H	00H	FFH	00H

5) Preset/Reset Multi-Register (Function Code 16)

Function Code 16

Query

This function code allows the user to modify the contents of a register. The example below is a request to an Acuvim II series meter with device address 1 to preset the CT1(500) and CT2(5) registers. The CT1 data address is 1008H and CT2 is at 1009H.

Transaction identifier hi	Transaction identifier lo	Protocol identifier hi	Protocol identifier lo	Length hi	Length lo	Unit identifier
00H	00H	00H	00H	00H	0BH	01H

Fun	Data start reg hi	Data start reg lo	Data #of reg hi	Data #of reg lo	Byte count	Value1 hi	Value1 lo	Value2 hi	Value2 lo
10H	10H	08H	00H	02H	04H	01H	F4H	00H	05H

Response

The normal response to a preset Multi-Register request including the MBAP Header, function code, data start register and the number of registers is shown below.

Transaction identifier hi	Transaction identifier lo	Protocol identifier hi	Protocol identifier lo	Length hi	Length lo	Unit identifier
00H	00H	00H	00H	00H	06H	01H

Fun	Data start reg hi	Data start reg lo	Data #of reg hi	Data #of reg lo
10H	10H	08H	00H	02H

10. Web Interface Readings and Parameter Settings

The AXM-WEB2 module supports the HTTPS protocol to allow for the use of a web interface. The user will need to access the AXM-WEB2 web interface to configure the module and use its functions. The web interface allows for remote initial setup of the Acuvim II meter.

The AXM-WEB2 web interface allows for different user access levels.

To access the web interface the IP address for the WEB2 either Ethernet 1, Ethernet 2 or a WiFi IP address must be known..

10.1 User Access Login

Enter the correct IP address of the module in the search bar of the internet browser to access the web interface of the AXM-WEB2

The user will be redirected to a web page prompting to select the Access Level and enter appropriate password for that level.

The **User** level is ideal for users who need only to take readings and view status from the meter.

The default password for the User level is **view**.

It is recommended that no more than 5 users are logged in at the same time for this level to ensure optimal performance of web interface.

The **Admin** level is ideal for users who need access to configurations on the meter or the web interface and to view readings.

The default password for the Admin level is **admin**.

ACCUENERGY
Sign in to continue

Access Level

User View reports and settings

Admin Edit settings, control meter

Password

Password

Sign in

SSL Certificate

The two different access levels are summarized below:

Access Level	Default Password	Read Parameter/Status	Configure Settings
User	view	Yes	No
Admin	admin	Yes	Yes

10.2 Dashboard

In the dashboard, the user will find the tabs to access different pages in the web interface such as '**Metering**', '**Logs**', and '**Settings**'. The dashboard is the first page the user will see once they have entered the correct password for the appropriate access level and is the same for both access levels.

The dashboard displays selected parameters from the different groups of metering parameters such as '**Basic Metering**', '**Power & Energy**', '**THD**' and '**Max Demand**'. By clicking on "Full report" under any one of these four metering parameter groups the user will be redirected to the web page which contains all the parameters supported by that metering parameter group.

The dashboard also displays how long the AXM-WEB2 module has been connected to the network since the last reboot of the module in the bottom left corner of the page.

The parameters on this page are updated every 5 sec.

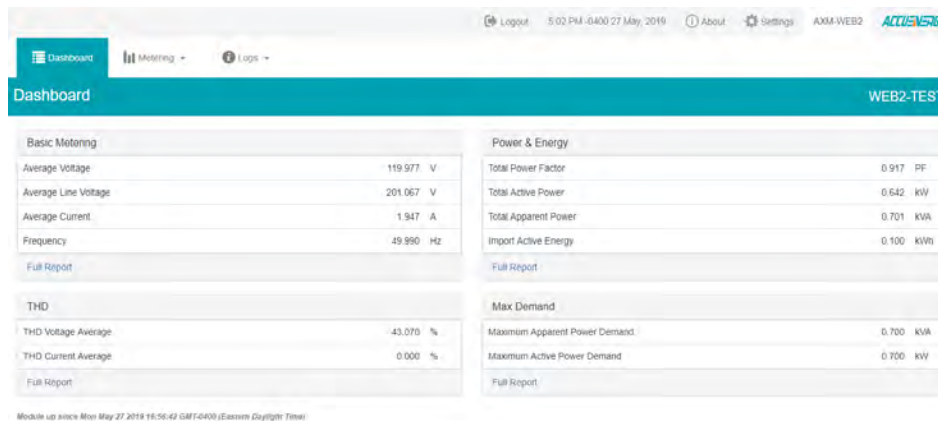

10.3 Metering web page

Click on the 'Metering' tab to visit the metering data web pages. There are eight kinds of metering parameter web pages. They are "Basic Metering", "Power & Energy", "Min/Max", 'THD', 'Harmonics', "Phase Angles", "Sequence" and "I/O". Each web page shows data from the Acuvim II series meter.

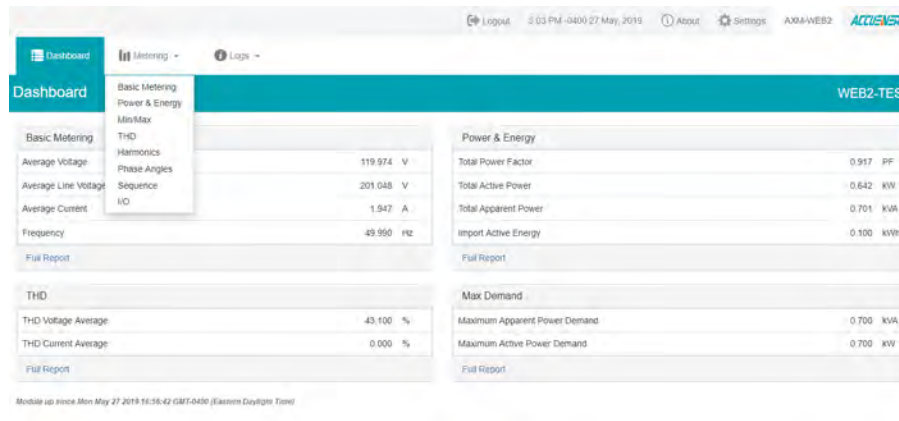

10.3.1 Basic Metering

The Basic Metering webpage includes the data of real-time parameters for the Acuvim II series meter. This includes the Line Voltages, Phase Voltages, Current, Neutral Current, Active, Reactive and Apparent Power, Power Factor, Frequency and Load type.

The parameters on this page are updated every 1 sec.

The values displayed in this webpage will depend on the wiring configuration mode of the meter. For example, if the meter is configured as '2LL' or '3LL' then the metering webpage will not display the phase readings, only the total values will be shown.

Chapter 10: Web Interface Readings and Parameter Settings

Parameter	Phase A	Phase B	Phase C	Average	Total
Line-to-Neutral Voltage v	120.027	119.852	120.005	119.975	-
Line-to-Line Voltage v	202.291	200.876	199.779	200.982	-
Current A	1.925	1.890	2.027	1.947	-
Neutral Current A	-	-	-	-	0.000
Active Power kw	0.205	0.210	0.227	-	0.642
Reactive Power kvar	-0.011	-0.005	-0.007	-	-0.023
Apparent Power kVA	0.231	0.226	0.243	-	0.700
Power Factor	0.889	0.927	0.935	-	0.917
Frequency Hz	49.990			-	-
Load Type	C			-	-

10.3.2 Power & Energy

The Power & Energy webpage shows the energy data for the Acuvim II series meter such as the Active and Reactive energy that is consumed and delivered as well as the Apparent energy per phase and total.

This webpage also shows the Demand parameters for the Active, Reactive and Apparent Power as well as the three phase Current demands.

The parameters in this webpage are updated every 5 sec.

Parameter	Import	Export	Total	Net
Active Energy kWh	154175.7	18855.0	203054.7	165292.7
Reactive Energy kvarh	6383.1	28272.9	23656.8	-24689.8
Apparent Energy kVAh	-	-	-	-545178.1

Parameter	Phase A	Phase B	Phase C
Import Active Energy kWh	51453.7	51568.0	51152.9
Export Active Energy kWh	9427.9	9488.6	0.3
Import Reactive Energy kvarh	3162.9	3189.2	0.1
Export Reactive Energy kvarh	83962.2	84193.9	84096.3
Apparent Energy kVAh	120362.4	120360.9	120401.6

Parameter	Phase A	Phase B	Phase C	Total
Active Power Demand kW	-	-	-	7.933
Reactive Power Demand kvar	-	-	-	-10.847
Apparent Power Demand kVA	-	-	-	13.439
Current Demand A	37.430	37.447	37.437	-

AXM-WEB2 for Acuvim II Series Power Meter

From the Power & Energy page user have the option to edit and write new Energy values. Simply click on the 'Manual Edit' button to edit the energy values.

This will be useful for users who want to start and monitor energy accumulation at a certain kilowatt hour reading. All energy parameters including individual phase, total, import, export, and net for the real, reactive and apparent energies support this feature.

The screenshot displays the 'Metering Power & Energy' interface. A 'Manual Edit' dialog box is open, titled 'Enter new value for Export Active Energy kWh - Phase C', with a text input field containing '36.1' and 'Save' and 'Cancel' buttons. The background shows a table of energy parameters and a demand table.

Parameter	Phase A	Phase B	Phase C	Net
Active Energy kWh				165233.0
Reactive Energy kvarh				-245890.2
Apparent Energy kVAh				345178.5

Parameter	Phase A	Phase B	Phase C	
Import Active Energy kWh	61403.8	61588.1	61162.6	
Export Active Energy kWh	9427.8	9459.5	0.3	
Import Reactive Energy kvarh	3162.9	3169.2	0.1	
Export Reactive Energy kvarh	6396.4	6420.0	64095.4	
Apparent Energy kVAh	120652.5	120966.0	104501.6	

Parameter	Phase A	Phase B	Phase C	Total
Active Power Demand kW	-	-	-	7.933
Reactive Power Demand kvar	-	-	-	-10.852
Apparent Power Demand kVA	-	-	-	13.442
Current Demand A	37.432	37.450	37.440	-

10.3.3 Min/Max

The Min/Max page shows the maximum and minimum statistics that the meter has records since the life time of the meter or from the last reset of the min/max statistics as well as the timestamps they were recorded at.

The parameters in this web page are updated every 10 sec.

Chapter 10: Web Interface Readings and Parameter Settings

Parameter	Min	Min Timestamp	Max	Max Timestamp
Phase A Voltage V	0.000	2019-05-23 16:00:25	168.100	2019-05-24 15:58:45
Phase B Voltage V	0.000	2019-05-23 16:00:25	170.000	2019-05-24 12:37:01
Phase C Voltage V	0.000	2019-05-23 16:00:25	173.600	2019-05-24 12:20:30
Line Voltage AB V	0.000	2019-05-23 16:00:25	277.700	2019-05-24 12:37:01
Line Voltage BC V	0.000	2019-05-23 16:00:25	277.800	2019-05-24 12:37:01
Line Voltage CA V	0.000	2019-05-23 16:00:25	277.300	2019-05-24 15:58:45
Phase A Current A	0.000	2019-05-23 16:00:25	230.000	2019-05-24 15:59:09
Phase B Current A	0.000	2019-05-23 16:00:25	220.000	2019-05-23 16:47:58
Phase C Current A	0.000	2019-05-23 16:00:25	220.000	2019-05-24 15:59:09
Active Power kW	-80.000	2019-05-24 15:59:10	70.000	2019-05-23 13:07:30
Reactive Power kvar	0.000	2019-05-23 13:07:30	0.000	2019-05-23 13:07:30
Apparent Power kVA	0.000	2019-05-23 16:00:25	80.000	2019-05-24 15:59:10
Power Factor	-1.000	2019-05-23 16:48:19	1.000	2019-05-23 13:07:30
Frequency Hz	0.000	2019-05-23 16:00:25	60.000	2019-05-23 13:07:30
Active Power Demand kW	-70.000	2019-05-23 17:02:27	70.000	2019-05-23 13:22:24
Reactive Power Demand kvar	0.000	2019-05-23 13:07:30	0.000	2019-05-23 13:07:30
Apparent Power Demand kVA	0.000	2019-05-23 13:07:30	70.000	2019-05-23 13:22:24
Voltage Unbalance %	0.000	2019-05-23 13:07:30	12.300	2019-05-27 16:53:12
Current Unbalance %	0.000	2019-05-23 13:07:30	100.000	2019-05-23 16:47:26
Phase A Voltage THD %	0.000	2019-05-23 16:00:25	51.140	2019-05-27 16:54:48
Phase B Voltage THD %	0.000	2019-05-23 16:00:25	40.690	2019-05-27 16:54:04
Phase C Voltage THD %	0.000	2019-05-23 13:07:30	37.780	2019-05-27 16:55:40
Phase A Current THD %	0.000	2019-05-23 13:07:30	0.000	2019-05-23 13:07:30
Phase B Current THD %	0.000	2019-05-23 13:07:30	0.000	2019-05-23 13:07:30
Phase C Current THD %	0.000	2019-05-23 13:07:30	0.000	2019-05-23 13:07:30

10.3.4 THD

The THD web page shows the power quality data such as the THD, THFF, Crest and K Factor for both the voltage and current.

The parameters in this web page are updated every 15 sec.

Parameter	Phase A	Phase B	Phase C
THD Voltage %	50.960	40.580	37.690
THD Current %	0.000	0.000	0.000
THD Odd Line Voltage %	25.090	27.490	26.150
THD Even Line Voltage %	43.790	29.870	27.150
Crest Factor Line Voltage	3.570	3.179	3.325
THFF Line Voltage %	27.820	43.690	26.010
THD Odd Current %	0.000	0.000	0.000
THD Even Current %	0.000	0.000	0.000
K Factor Current	0.000	0.000	0.000

10.3.5 Harmonics

The Harmonics web page will show the harmonics of the voltage and the current waveform being measured. It will display the harmonics of each phase in graphical and tabular format. Select between voltage and current to view their respective harmonics as well as between 2nd - 31st harmonics or 32nd - 63rd from the drop down list.

The parameters in this web page are updated every 15 sec.

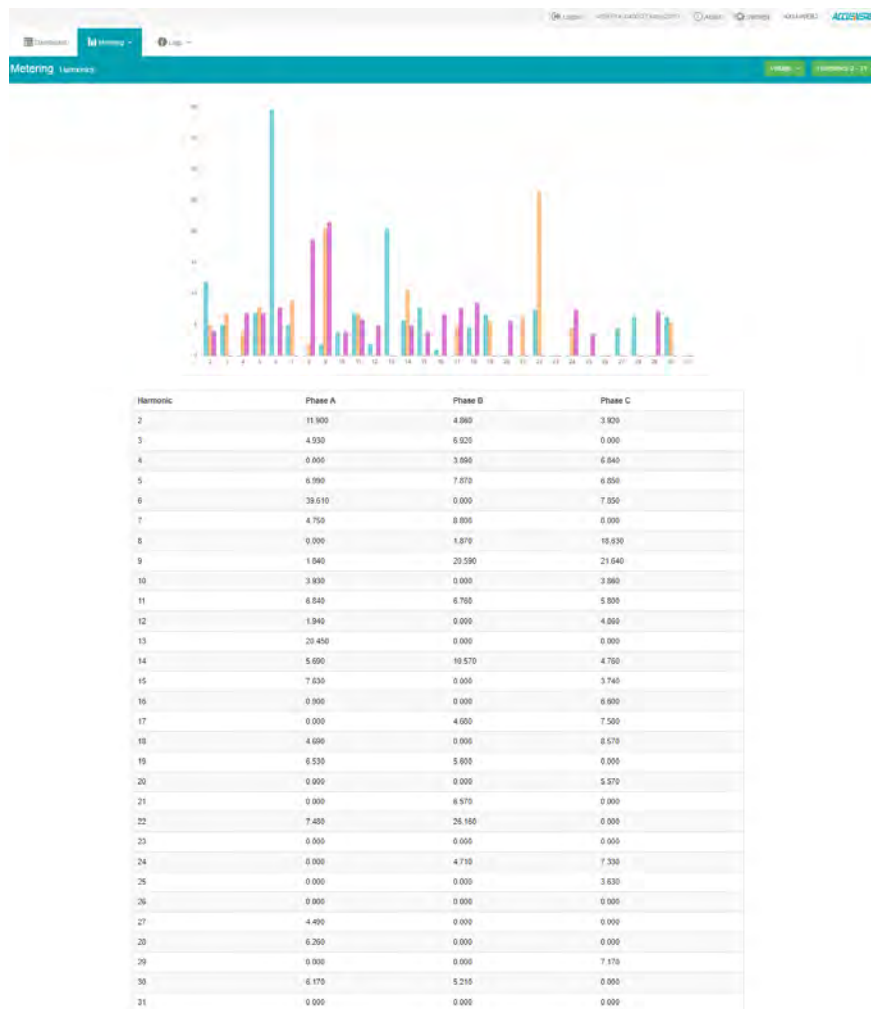

10.3.6 Phase Angles

The Phase Angles web page will show the phase angles of the voltage and current waveform being measured which can be used for remote troubleshooting. This page provides a visual diagram of the phase angles with respect to the voltage connected to the Phase A voltage input.

The parameters in this web page are updated every 10 sec.

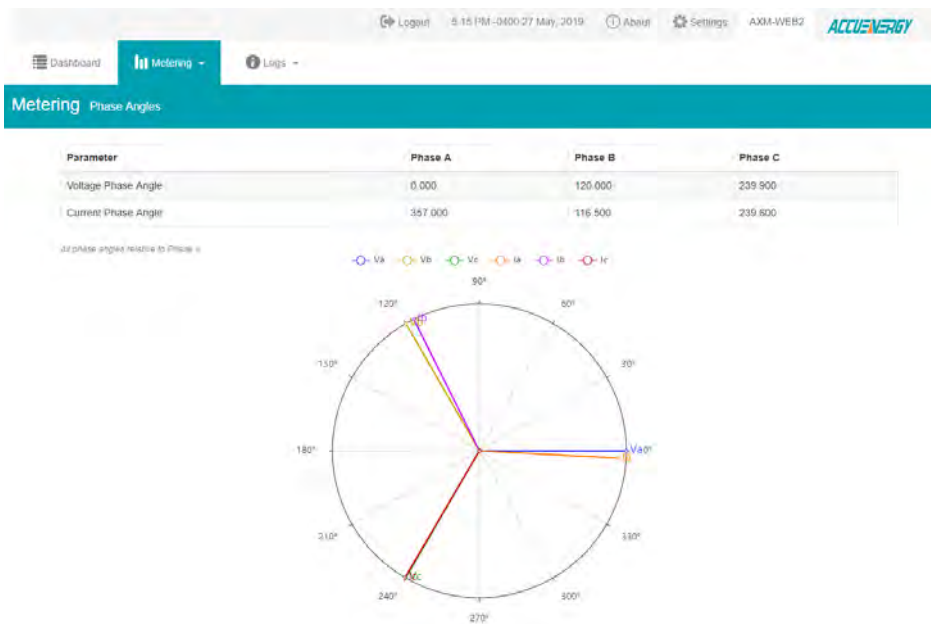

10.3.7 Sequence

The Sequence web page will show the positive, negative and zero components of the voltage and current waveform being measured.

The parameters in this web page are updated every 10 sec.

AXM-WEB2 for Acuvim II Series Power Meter

Metering Sequence

Parameter	Positive	Negative	Zero
Voltage	109.900	1.612	1.530
Real Voltage	109.900	-1.600	-1.500
Imaginary Voltage	0.000	-0.200	0.300
Current	0.019	0.000	0.000
Real Current	0.019	0.000	0.000
Imaginary Current	0.000	0.000	0.000

Unbalance

Voltage Unbalance Factor %	1.458
Current Unbalance factor %	0.000

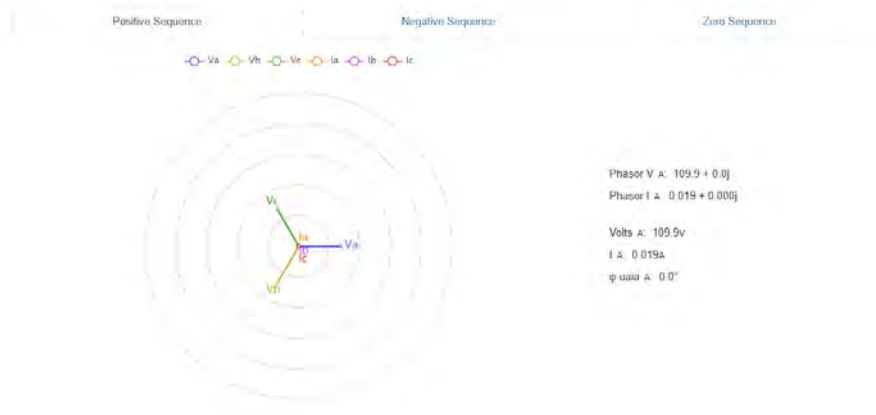

10.3.8 I/O

The I/O web page displays the status of the I/O modules that are connected and their values depending on the model of the module that is connected to the meter. I.E. The AXM-IO11 module will display the Relay Output status(on/off), DI status/counter. The I/O module can be configured in the general settings section of the web interface which is discussed later in the manual.

The parameters in this web page are updated every 5 sec.

Chapter 10: Web Interface Readings and Parameter Settings

From the IO readings page, users can perform the following functions depending on the IO module being used:

IO Module	Functions
AXM-IO1-1/2	<ul style="list-style-type: none"> • Read Digital Input Status or Digital Input Count value depending on the mode configured (Channels 1-6) • Read the Relay Output Channel 1 and 2 Status ON/OFF • Toggle Relay Output Channels 1 and 2 ON/OFF <p>NOTE: Relay must be configured for Control Mode for toggle function to work</p> <ul style="list-style-type: none"> • Reset DI Counter back to 0 (Counters 1-6)
AXM-IO2-1/2	<ul style="list-style-type: none"> • Read Digital Input Status or Digital Input Count value depending on the mode configured (Channels 1-4) • Read value of the Analog Output Channels 1 and 2, either 4-20mA, 0-20mA, 0-5V, 1-5V signals • Reset DI Counter back to 0 (counters (1-4)
AXM-IO3-1/2	<ul style="list-style-type: none"> • Read Digital Input Status or Digital Input Count value depending on the mode configured (Channels 1-4) • Read the Relay Output Channel 1 and 2 Status ON/OFF • Toggle Relay Output Channels 1 and 2 ON/OFF <p>NOTE: Relay must be configured for Control Mode for toggle function to work</p> <ul style="list-style-type: none"> • Read Analog Input Channels 1 and 2, either 4-20mA, 0-20mA, 0-5V, 1-5V signals • Reset DI Counter back to 0 (Counters 1-4)

AXM-WEB2 for Acuvim II Series Power Meter

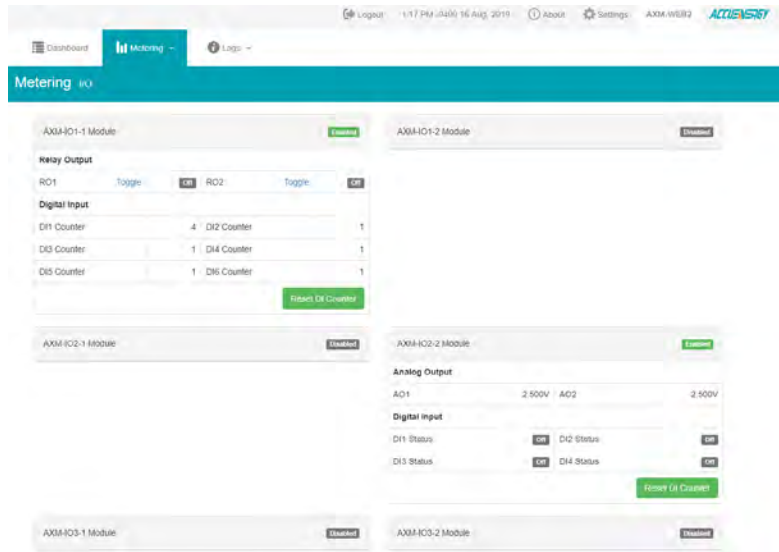

10.4 Logs

Click on the 'Logs' tab to visit the metering logs web pages.

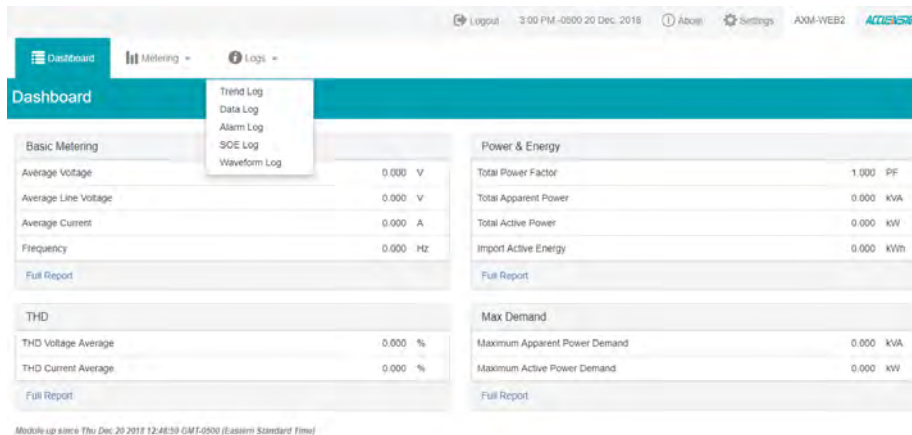

There are five kinds of logs that can be viewed, they are "Trend Log", "Data Log", "Alarm Log", "SOE Log" and "Waveform Log"(Only available in AcuVim IIW model).

Each web page shows data from the Acuvim II series meter.



10.4.1 Trendlog

The Trend Log web page includes the real-time and energy trend diagram. The real-time trend log diagram can be selected to show the following parameters phase voltage, line voltage, current, active power, reactive power, apparent power and power factor for each phase as well as the totals. The energy trend log shows the imported and exported active energy, reactive energy, total energy, net energy and apparent energy.

The data of the trend log can be previewed and downloaded as a .csv file by clicking the 'Data Review'  and 'Data'  icons on the right top side of the diagram. The trend log diagram can also be saved as an image by clicking the 'Image'  icon.

Realtime

The real time parameters can be trended at different time intervals depending on the Time Frame selected. Listed below are the time intervals for each possible time frame setting:

Time Frame	Time Intervals
Last 10 minutes	1 second 15 seconds 1 minute
Last 1 Hour	1 minute
Today	15 minutes 1 hour
Yesterday	15 minutes 1 hour
Last 7 days	15 minutes 1 hour 1 day
Last 30 days	1 hour 1 day
Last Month	1 hour 1 day
Custom Range	Dependent on range specified

AXM-WEB2 for Acuvim II Series Power Meter



Energy

Similarly the energy parameters can be trended at different time intervals depending on the Time Frame selected. The table below displays the time intervals:

Time Frame	Time Intervals
Last 10 minutes	15 seconds
	1 minute
Last 1 Hour	1 minute
	15 minutes
Today	1 hour
	15 minutes
Yesterday	1 hour
	15 minutes
Last 7 days	1 hour
	1 day
	15 minutes
Last 30 days	1 hour
	1 day
This Month	1 hour
	1 day
Last Month	1 hour
	1 day
Last Year	1 day
	1 month
Custom Range	Dependent on range specified

Chapter 10: Web Interface Readings and Parameter Settings

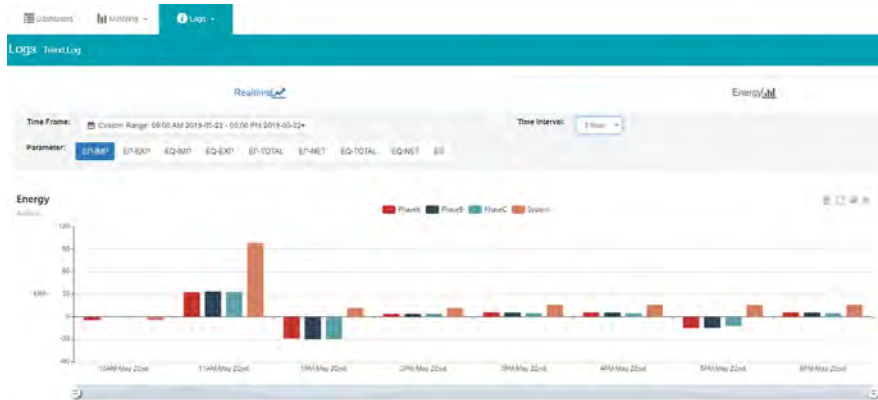

Data Preview

The data preview allows the user to view the graphical data in tabular form.

User can also download this data into a csv file for further examination.

The screenshot shows the 'Data Preview' section of the web interface. The 'Time Frame' is set to 'Last 1 Hour: 04:22 PM 2019-05-27 - 05:22 PM 2019-05-27'. The 'Time Interval' is set to '1 minute'. The 'Parameter' dropdown is set to 'P'. The table displays data for parameters: VLN, VLL, P, Q, S, PF.

Time	VLN	VLL	P	Q	S	PF
17:08	20.5	21.0	22.7	64.3		
17:09	20.5	21.0	22.7	64.3		
17:10	20.5	21.0	22.7	64.3		
17:11	20.0	21.0	22.7	64.3		
17:12	20.5	21.0	22.7	64.3		
17:13	20.5	21.0	22.7	64.2		
17:14	20.5	21.0	22.7	64.3		
17:15	20.5	21.0	22.7	64.3		
17:16	20.0	21.0	22.7	64.2		
17:17	20.0	21.0	22.7	64.3		
17:18	20.5	21.0	22.7	64.2		
17:19	20.5	21.0	22.7	64.2		
17:20	20.5	21.0	22.7	64.2		
17:21	20.5	21.0	22.7	64.2		
17:22	20.5	21.0	22.7	64.3		
17:23	20.5	21.0	22.7	64.2		

10.4.2 Trendlog Management

The trendlog management page allows the user to download data from the meters data base. The trendlog management page acts as a back up to the data logs for users.

Log Param Type: Users can select which data they want to download from the meter. In the drop down menu there is a timestamp range to show the available data.

NOTE: Energy data will remain in meter data base for up to years, whereas all other metering data will remain in the meter data base for up to 1 month before overriding.

Log Param Type Detail: This setting allows users to modify what values they see in the data log. Users can select the following parameter details:

- Instantaneous
- Minimum
- Maximum
- Average

Only the 'Real-time' and 'Demand' parameters support the minimum, maximum and average parameter type details. All other parameter types such as Energy, Power Quality, and IO only support the instantaneous values displayed in the the data log.

The log file will be downloaded as a .gz file and will need to be unzipped in order to view the csv file.

The screenshot shows the 'Trend Log Management' web interface. At the top, there is a teal header with the text 'Logs Trend Log Management'. Below this, the page title is 'TrendLog Management'. The 'Log Param Type' dropdown menu is set to 'Real-Time' with a timestamp range of '(2019-08-06 - 2019-12-16)'. There are two columns: 'Not selected' (empty) and 'Selected' (containing a list of parameters: Line-to-Neutral Voltage, Line-to-Line Voltage, Line Current, Neutral Current, Active Power, Reactive Power, Apparent Power, Power Factor, Frequency, and Load Type). Below these columns are navigation buttons: '>', '<', 'All', and 'Clear'. The 'Log Param Type Detail' section has four radio buttons: 'Instantaneous Value' (checked), 'Minimum Value', 'Maximum Value', and 'Average Value'. The 'Start Time' is '2019-08-06' and the 'End Time' is '2019-12-16'. There is a 'Log interval' dropdown menu. A green 'Generate File' button is present. Below the button, a message states: 'Trend log file is ready. (Generating new file will delete current file)'. The filename is 'AN20190802-2019-12-10115-14-45-0500-5min.csv.gz'. A note at the bottom says: 'Note: File size is 112.82 KB, delete file to free up disk space.'

Clear Logs

The clear logs function allows the user to clear and remove all metering data stored on the module database. This will allow users to clear all readings and historical data without re-setting all features and functions. Users can clear the logs by clicking on the button at the bottom of the Trendlog page.

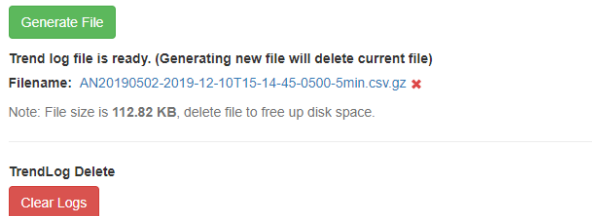

To clear the logs click on "Clear Logs", a warning message is displayed notifying users that this action is irreversible once done.

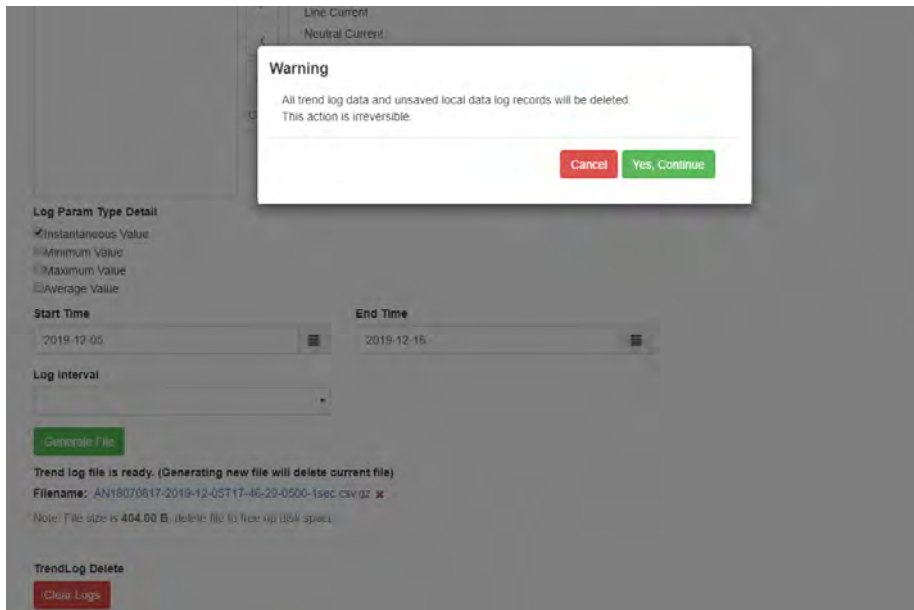

NOTE: This cannot be undone, once the trend log is cleared all data in meter database is cleared.







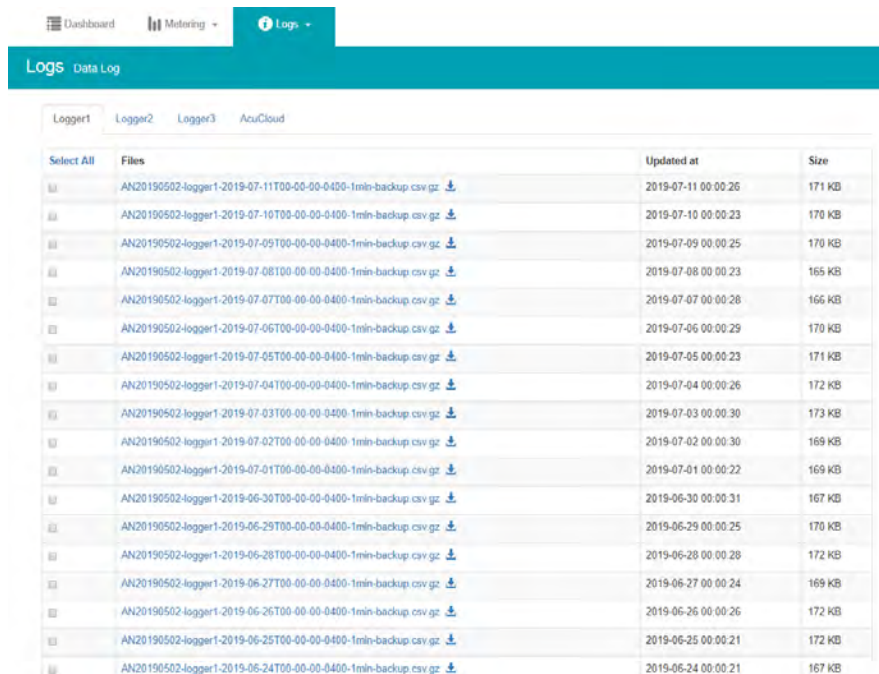











10.4.3 Data Log

The data log web page includes all the data file for three different loggers and AcucCloud.

You can select the different loggers by clicking the logger tab. After the logger is selected, the log file for this logger will show on the screen with the update time and file size. To download the file, click on the download icon  to save the file in the computer. The data log will be saved as a compressed csv file.



The screenshot shows a web interface with a navigation bar containing 'Dashboard', 'Metering', and 'Logs'. Below the navigation bar is a header for 'Logs Data Log'. There are four tabs: 'Logger1', 'Logger2', 'Logger3', and 'AcuCloud'. The 'Logger1' tab is selected. Below the tabs is a table with the following columns: 'Select All', 'Files', 'Updated at', and 'Size'. The table contains 20 rows of log files, each with a checkbox, a file name, a download icon, an update time, and a file size.

Select All	Files	Updated at	Size
<input type="checkbox"/>	AN20190502-logger1-2019-07-11T00-00-00-0400-1min-backup.csv.gz 	2019-07-11 00:00:26	171 KB
<input type="checkbox"/>	AN20190502-logger1-2019-07-10T00-00-00-0400-1min-backup.csv.gz 	2019-07-10 00:00:23	170 KB
<input type="checkbox"/>	AN20190502-logger1-2019-07-09T00-00-00-0400-1min-backup.csv.gz 	2019-07-09 00:00:25	170 KB
<input type="checkbox"/>	AN20190502-logger1-2019-07-08T00-00-00-0400-1min-backup.csv.gz 	2019-07-08 00:00:23	165 KB
<input type="checkbox"/>	AN20190502-logger1-2019-07-07T00-00-00-0400-1min-backup.csv.gz 	2019-07-07 00:00:28	166 KB
<input type="checkbox"/>	AN20190502-logger1-2019-07-06T00-00-00-0400-1min-backup.csv.gz 	2019-07-06 00:00:29	170 KB
<input type="checkbox"/>	AN20190502-logger1-2019-07-05T00-00-00-0400-1min-backup.csv.gz 	2019-07-05 00:00:23	171 KB
<input type="checkbox"/>	AN20190502-logger1-2019-07-04T00-00-00-0400-1min-backup.csv.gz 	2019-07-04 00:00:26	172 KB
<input type="checkbox"/>	AN20190502-logger1-2019-07-03T00-00-00-0400-1min-backup.csv.gz 	2019-07-03 00:00:30	173 KB
<input type="checkbox"/>	AN20190502-logger1-2019-07-02T00-00-00-0400-1min-backup.csv.gz 	2019-07-02 00:00:30	169 KB
<input type="checkbox"/>	AN20190502-logger1-2019-07-01T00-00-00-0400-1min-backup.csv.gz 	2019-07-01 00:00:22	169 KB
<input type="checkbox"/>	AN20190502-logger1-2019-06-30T00-00-00-0400-1min-backup.csv.gz 	2019-06-30 00:00:31	167 KB
<input type="checkbox"/>	AN20190502-logger1-2019-06-29T00-00-00-0400-1min-backup.csv.gz 	2019-06-29 00:00:25	170 KB
<input type="checkbox"/>	AN20190502-logger1-2019-06-28T00-00-00-0400-1min-backup.csv.gz 	2019-06-28 00:00:28	172 KB
<input type="checkbox"/>	AN20190502-logger1-2019-06-27T00-00-00-0400-1min-backup.csv.gz 	2019-06-27 00:00:24	169 KB
<input type="checkbox"/>	AN20190502-logger1-2019-06-26T00-00-00-0400-1min-backup.csv.gz 	2019-06-26 00:00:26	172 KB
<input type="checkbox"/>	AN20190502-logger1-2019-06-25T00-00-00-0400-1min-backup.csv.gz 	2019-06-25 00:00:21	172 KB
<input type="checkbox"/>	AN20190502-logger1-2019-06-24T00-00-00-0400-1min-backup.csv.gz 	2019-06-24 00:00:21	167 KB

Deleting Data Logs

To delete the data logs users can check the box next to the data log file and click on the 'Delete Selected' button at the bottom of the page.

Users will be prompted by a window asking to confirm the data log delete.

NOTE: Deleting the data log is permanent, this cannot be undone once deleted.

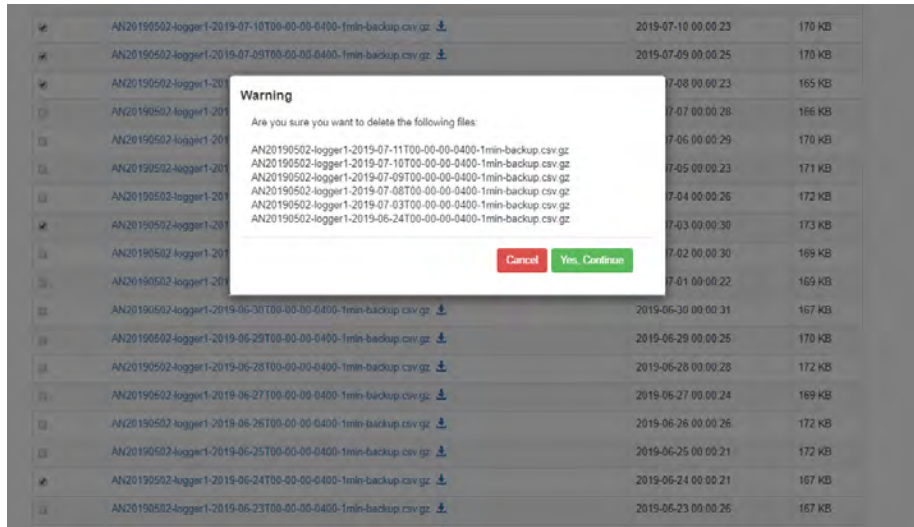

10.4.4 Alarm Log

The Alarm Log web page provides the user with a summary of the alarm events that have occurred with the meter. It will show the status of up to 16 alarm events indicating the alarm ID, status, parameter, value that exceeded or went below the threshold and the timestamp of the alarm event.

Once all 16 alarm events are full, the newest alarm event will then wrap around to alarm 1. The parameters in the alarm status web page are updated every 10 seconds.

Timestamp	Alarm ID	Parameter	Value	Status
2019-06-27 12:58:44.838	4	Phase A Voltage	118.900V	Alarm
2019-06-27 12:58:44.838	5	Total Active Power	7.800kW	Alarm
2019-06-27 12:58:44.838	10	Phase A Reactive Power	-2.300kvar	Alarm
2019-07-27 10:13:28.938	1	Frequency	59.970Hz	Clear
2019-07-27 07:50:17.300	1	Frequency	59.930Hz	Alarm
0000-00-00 00:00:00.000	0	Frequency	0.000Hz	Clear
0000-00-00 00:00:00.000	0	Frequency	0.000Hz	Clear
0000-00-00 00:00:00.000	0	Frequency	0.000Hz	Clear
0000-00-00 00:00:00.000	0	Frequency	0.000Hz	Clear
0000-00-00 00:00:00.000	0	Frequency	0.000Hz	Clear
0000-00-00 00:00:00.000	0	Frequency	0.000Hz	Clear
0000-00-00 00:00:00.000	0	Frequency	0.000Hz	Clear
0000-00-00 00:00:00.000	0	Frequency	0.000Hz	Clear
0000-00-00 00:00:00.000	0	Frequency	0.000Hz	Clear
0000-00-00 00:00:00.000	0	Frequency	0.000Hz	Clear
0000-00-00 00:00:00.000	0	Frequency	0.000Hz	Clear

10.4.5 SOE Log

The SOE web page will display the Sequence of Event log for the enabled I/O module that is attached to the Acuvim II series meter with timestamps and will display the DI status for up to 20 SOE events. The SOE must be enabled from the Acuvim software.

The SOE log parameters are updated every 10 sec.

Group	DI1 Status	DI2 Status	DI3 Status	DI4 Status	DI5 Status	DI6 Status	Timestamp
Group 1	Off	Off	Off	Off	Off	Off	2018-12-19 17:46:28
Group 2	Off	Off	Off	Off	On	Off	2018-12-19 17:46:34
Group 3	Off	Off	Off	Off	Off	Off	2018-12-19 17:46:34
Group 4	Off	Off	On	Off	Off	Off	2018-12-20 08:46:50
Group 5	Off	Off	Off	Off	Off	Off	2018-12-20 08:46:57
Group 6	On	Off	Off	Off	Off	Off	2018-12-20 10:32:41
Group 7	Off	Off	Off	Off	Off	Off	2018-12-20 10:32:41
Group 8	On	Off	Off	Off	Off	Off	2018-12-20 10:32:41
Group 9	Off	Off	Off	Off	Off	Off	2018-12-20 10:32:49
Group 10	On	Off	Off	Off	Off	Off	2018-12-12 13:22:03
Group 11	Off	Off	Off	Off	Off	Off	2018-12-13 08:50:12
Group 12	Off	Off	On	Off	Off	Off	2018-12-13 08:50:22
Group 13	Off	Off	Off	Off	Off	Off	2000-00-00 00:00:00
Group 14	On	Off	Off	Off	Off	Off	2018-12-17 08:53:36
Group 15	Off	Off	Off	Off	Off	Off	2018-12-17 08:53:42
Group 16	On	Off	Off	Off	Off	Off	2018-12-17 15:18:14
Group 17	Off	Off	Off	Off	Off	Off	2018-12-17 15:18:21
Group 18	On	Off	Off	Off	Off	Off	2018-12-19 17:45:17
Group 19	Off	Off	Off	Off	Off	Off	2018-12-19 17:45:26
Group 20	On	Off	Off	Off	Off	Off	2018-12-19 17:46:24

10.4.6 Waveform Log

The waveform log is available only on Acuvim IIW models of the Acuvim II series meter. This meter supports a waveform capture function that allows users to capture and record 10 cycles before and after the triggering point whether it be a voltage sag, swell, or over current. The waveform log on the web interface allows users to view these waveforms whenever a power quality event has occurred. The log displays a table that includes the waveform files, the time the waveform is updated at, and the size of the file. The waveform file name includes the timestamp when the event occurred as well as the parameter name/event name that triggered the power quality event.

The screenshot shows the 'Waveform Log' page in the Acuvim II web interface. The page has a header with 'Logout', '1:22 PM 0400 16 Aug 2019', 'About', 'Settings', 'AXM WEB2', and the 'ACUENERGY' logo. A navigation bar includes 'Dashboard', 'Metering', and 'Logs'. The main content area is titled 'Logs Waveform Log' and features a 'Manual Capture' button. Below this is a table with the following data:



Select All	Files	Updated at	Size (Unzipped)
<input type="checkbox"/>	2019-08-16T13-16-01.362-0400_Vabc_VOLTAGE_SAG ↓ ↑	2019-08-16 13:17:00	36 KB
<input type="checkbox"/>	2019-08-16T13-06-22.704-0400_Vc_VOLTAGE_SAG ↓ ↑	2019-08-16 13:07:22	36 KB
<input type="checkbox"/>	2019-08-16T12-38-40.188-0400_Vc_VOLTAGE_SAG ↓ ↑	2019-08-16 12:39:28	36 KB
<input type="checkbox"/>	2019-08-16T11-53-47.130-0400_Va_VOLTAGE_SAG ↓ ↑	2019-08-16 11:54:14	39 KB
<input type="checkbox"/>	2019-08-16T11-47-24.356-0400_Vc_VOLTAGE_SAG ↓ ↑	2019-08-16 11:48:17	40 KB
<input type="checkbox"/>	2019-08-16T11-47-15.666-0400_Va_VOLTAGE_SAG ↓ ↑	2019-08-16 11:47:51	40 KB
<input type="checkbox"/>	2019-08-16T11-45-55.715-0400_Vb_VOLTAGE_SAG ↓ ↑	2019-08-16 11:46:53	39 KB
<input type="checkbox"/>	2019-08-16T11-44-37.24-0400_Vb_VOLTAGE_SAG ↓ ↑	2019-08-16 11:45:07	40 KB
<input type="checkbox"/>	2019-08-16T11-44-19.132-0400_Va_VOLTAGE_SAG ↓ ↑	2019-08-16 11:44:43	40 KB
<input type="checkbox"/>	2019-08-16T11-42-05.294-0400_Vc_VOLTAGE_SAG ↓ ↑	2019-08-16 11:42:28	40 KB
<input type="checkbox"/>	2019-08-16T11-38-57.968-0400_Va_VOLTAGE_SAG ↓ ↑	2019-08-16 11:39:17	39 KB
<input type="checkbox"/>	2019-08-16T11-38-05.241-0400_Vc_VOLTAGE_SAG ↓ ↑	2019-08-16 11:38:26	41 KB

Below the table is a 'Delete Selected' button and a blue square icon.

AXM-WEB2 for Acuvim II Series Power Meter

To view the waveform click on the  icon. Users can select which voltage or current phase they want to view on the graph during the power quality event.

An image of the graph can be downloaded by clicking on the  button.

Users can zoom into the graph for further detail by clicking on the . The graph can be reset back by double clicking the  button.

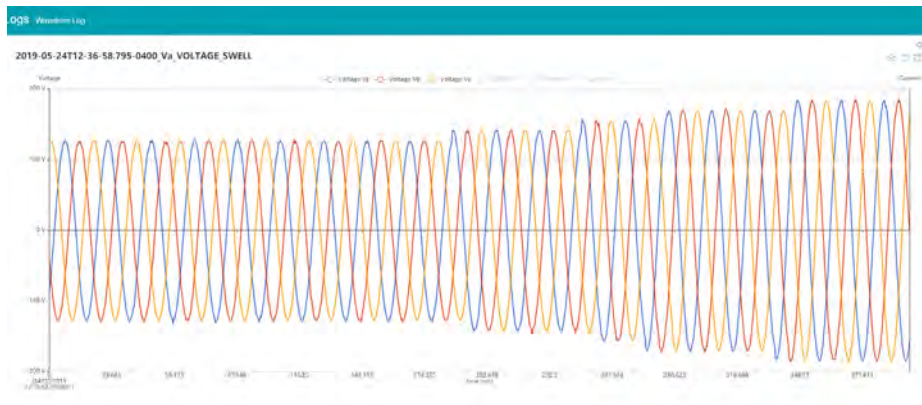

Users can select 'Close' to close the waveform and navigate back to the waveform Log.

Users can perform a manual waveform capture by clicking on 'Manual Capture'. This will manually capture voltage and current waveforms of the system being monitored. Once the waveform is capture it will take approximately 1-2 minutes to appear in the waveform log.

Chapter 10: Web Interface Readings and Parameter Settings

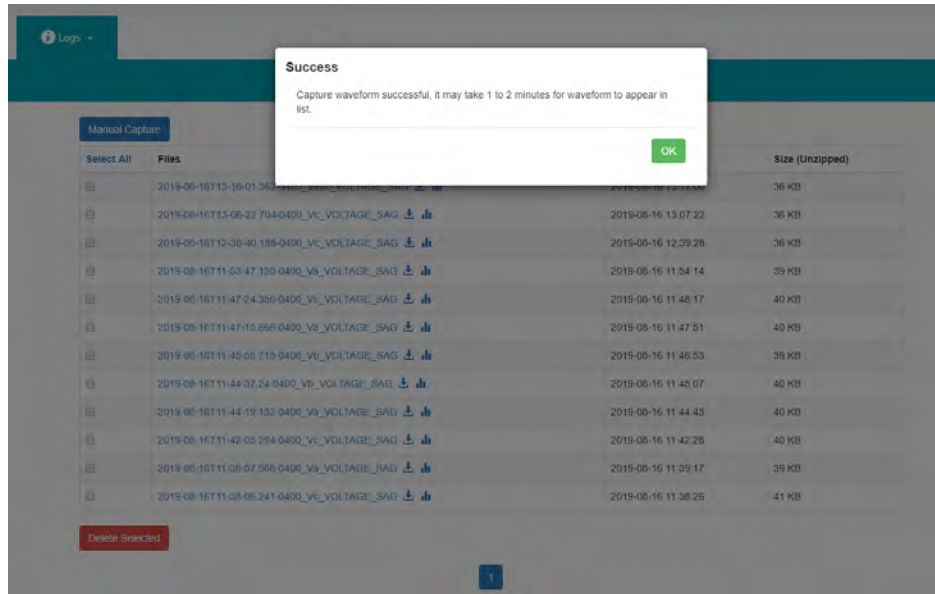

The file name for the manually captured waveform will include the timestamp the capture occurred and the reason will say 'MANUAL' at the end of the file.



In the waveform log page, user also have the option to select and delete waveform files. Simply click on the check box next to the file to select it, alternatively users can click on the 'Select All' button. Once all files are selected click on delete to remove the files from the waveform log.

AXM-WEB2 for Acuvim II Series Power Meter

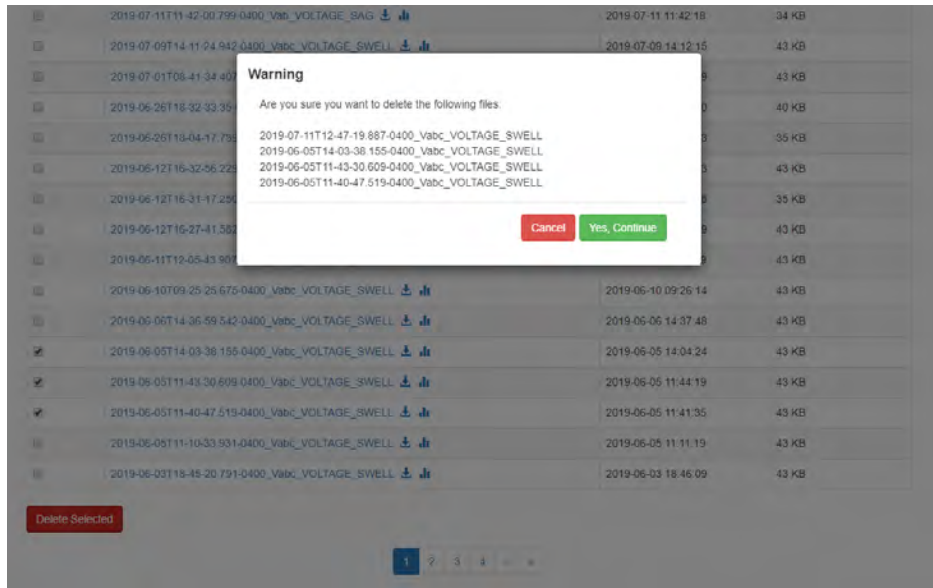

COMTRADE

The AXM-WEB2 allows users to download the waveform data as a COMTRADE file. COMTRADE is a file format for storing waveform data related to transient power system disturbances.

The file can be downloaded from the waveform log by clicking on the file name or by clicking on the  button. Once downloaded the file can be read using a COMTRADE file reader where users can further analyze the waveform data provided from the meter.

10.5 About

The About tab located at the top right corner of the web interface allows users to view the Device Information page. This page provides users with information about the Acuvim II series meter and the AXM-WEB2 module. The Device Information contains the model of the Acuvim II meter, serial number, firmware version and the meter addresses. It also contains the serial number, firmware version, hardware version and the MAC addresses of the AXM-WEB2 module.

The screenshot shows the 'Device Information' page of the AXIA-WEB2 interface. At the top, there is a navigation bar with 'Logout', '12:10 PM -0500 16 Dec, 2019', 'About', 'Settings', 'AXIA-WEB2', and the 'ACCUENERGY' logo. The main content area is titled 'Device Information' and contains a table with two columns: 'Setting' and 'Value'.

Setting	Value
Meter Model	AcuimilW-D-RCT
Meter Serial Number	AH18100109
Meter Firmware Version	v4.05
Device Description	WEB2 v1.11
Module Model	AXIA-WEB2
Module Serial Number	AN18070817
Module Hardware Version	v1.01a
Module Firmware Version	v1.11
Ethernet 1 MAC Address	EC:C3:8A:20:29:DC
Ethernet 2 MAC Address	EC:C3:8A:20:29:DD
WiFi MAC Address	00:25:CA:38:BD:59
Meter Channel 1 Address	123
Meter Channel 2 Address	1
Seals Status	Open
Meter Boot Version	FP00203910

10.6 Settings

10.6.1 Meter

General Setting

The basic metering configurations needed to set up the meter can be applied from the web interface by clicking on Settings and selecting the 'Meter' tab. On the metering tab users will see the 'General' tab selected and the page presented. The general page include the following settings:

Device Description: A description for the meter can be provided in this field which will display on the Dashboard page.

Voltage Wiring: Select the type of wiring that the meter will be monitoring from the modes in the drop down list.

Current Wiring: Select the number of CT's that will be connected to the meter to measure the current.

PT1: Enter the rated input of the potential transformer that is connected to the meter. Possible range is from 50 to 1,000,000V. By default PT1 is 400.

PT2: Enter the rated output of the potential transformer. Possible range is from 50 to 400V. The default PT2 setting is 400.

NOTE: If the voltage input is connected directly to the meter and there are no PTs (Potential Transformers) stepping down the voltage to the meters voltage input then the PT1 and PT2 settings can be left as the default of 400.

AXM-WEB2 for Acuvim II Series Power Meter

CT1: Enter the rated input of the current transformer that is used with the meter. Possible ranges for the CT1 are from 1 to 50000A.

The default settings for CT1 are dependent on the current input type of the Acuvim II meter. The following table displays the default CT1 values for the different Current input options.

Acuvim II Current Input	Default CT1 Value
1A	1
5A	5
333mV	1
RCT	1000
80mA/100mA/200mA	1

CT2: Select the rated output of the current transformer from the drop down list. By default this setting is already configured.

NOTE: CT2 is configurable only for 5A and mA current inputs, 5A can be either 5A or 1A and mA can be either 80mA, 100mA or 200mA.

The screenshot shows the 'Settings Meter' configuration page. The 'General' tab is selected. Under 'Device Description', the value 'WEB2 v0.30' is entered. The 'Wiring' section has 'Voltage Wiring' set to '3LL - Three Phase Three Wire Delta --- Compatible with 2CT & 3CT only' and 'Current Wiring' set to '3CT --- Compatible with 2LL, 3LL & 3LN only'. The 'PT and CT Ratios' section shows PT1 and PT2 both set to '400.0'. CT1 is set to '1000' and CT2 is set to 'Rogowski Coil'.

Real time Reading: Select the mode of the readings for the meter when it is polled through Modbus. By default the meter is in Secondary mode which will require some parameters to be scaled by a relationship. Configuring the meter in Primary mode does not require any scaling.

I A Direction: Represents the flow of direction for the Phase A current being measured, configure this setting to troubleshoot issues related to incorrect polarity of readings such as real power, Power Factor and etc.

I B Direction: Represents the flow of direction for the Phase B current being measured, configure this setting to troubleshoot issues related to incorrect polarity of readings such as real power, Power Factor and etc.

I C Direction: Represents the flow of direction for the Phase C current being measured, configure this setting to troubleshoot issues related to incorrect polarity of readings such as real power, Power Factor and etc.

Demand Settings

Sliding Window: This setting refers to the demand type. There are 4 demand types that are supported by the Acuvim II series meter, users can choose one of the following:

- 1. Fixed Window** - The demand is calculated based on selecting the calculation period between 1-30min. The meter will calculate and update the demand values at the end of each calculation period.
- 2. Sliding Window** - The demand is calculated by selecting the calculation period between 1-30 min. The meter will average the energy accumulated within this period of time and the demand value is updated every minute.
- 3. Thermal** - The demand is calculated based on thermal response, used in thermal demand meters. This method uses a sliding window to update the demand value at the end of each calculation period.
- 4. Rolling Window** - The demand is based on selecting a calculation period between 1-30min, a subinterval(Demand Calculation Slip Time) and the demand value is updated at each subinterval. The subinterval must be a factor of the calculation period. For example, with a calculation period of 15min, the subinterval can be configured as 5min.

Sub Interval: The sub interval setting is only relevant if the Rolling Window Method is selected, this method requires a sub-interval time that must be a factor of the demand calculation period. the range for this setting is from 1-30 minutes.

AXM-WEB2 for Acuvim II Series Power Meter

Average Interval: The average interval window is the calculation period of the demand, and can be set from 1-30 minutes.

On-board RS485

Protocol: Select the protocol for the Acuvim II RS485 port, the protocol can be set to Modbus or DNP 3.

Address: Select the RS485 address for the meter, the range for this setting is from 1-247.

Baud Rate: The baud rate is the communication speed of the RS485 data transfer, this ranges from 1200-38400.

Parity: Select the parity bit setting for the communication.

Realtime Reading	<input checked="" type="radio"/> Primary	<input type="radio"/> Secondary	
I A Direction	<input type="radio"/> Positive	<input checked="" type="radio"/> Negative	
I B Direction	<input type="radio"/> Positive	<input checked="" type="radio"/> Negative	
I C Direction	<input type="radio"/> Positive	<input checked="" type="radio"/> Negative	
Demand			
Sliding Window	Sub-Interval	Averaging Interval Window	
Fixed Window Demand	15 mins Range 1-30	30 mins Range 1-30	
On-board RS485			
Protocol	Address	Baud Rate	Parity
Modbus	30 Range 1-247	38400	Odd

Display

Current Password: This password relates to the four digit password used to access the meter settings from the display of the meter. By default it is 0000, the range for this setting is 0000-9999.

New Password: Enter in a new four digit password.

Repeat Password: Repeat the new password configured in the previous setting

Chapter 10: Web Interface Readings and Parameter Settings

Backlight: This setting refers to how long back light on the meters display is on for, the range is from 0-120 minutes, where 0 would disable to back light from turning off.

Rated Load: The rated load can be represented in terms of either power or current.

- If current is selected the rated current that is used would be the CT1 setting value in the PT and CT ratio settings section of the web page. For example if CT1 is set for 1000A, and the average current the meter is monitoring is 500A, the load percentage would be 50% (500/1000A).
- If power is selected the rated primary power would be used in the load percentage calculation. The max primary power can be calculated as follows:

$$\text{Max Primary Power without using PTs} = 3 * (480) * (\text{CT1})$$

$$\text{Max Primary Power using PTs} = 3 * (\text{PT1}) * (\text{CT1})$$

The max primary power would be the power that is entered in this setting.

The load percentage is displayed on the front of the Acuvim II meter display. The load percentage is calculated based on the following equation:

Load Percentage = (Active System Power / ((5A or 1A) * User Setting)) * 100% , where the meter will have either a 5A or 1A current input. If users have Acuvim II meters with Rogowski Coil (RCT), 333mV and mA type Current Inputs then they would use 1A in this equation.

For example if the max primary power of your system is 576000W (or 576kW), your system is currently using 211kW and the meters current input type is 5A, then the load percentage would be calculated as follows:

$$\text{Load Percentage} = (211\text{kW} / (5 * 576\text{kW})) * 100 = 7\%$$



AXM-WEB2 for Acuvim II Series Power Meter

The screenshot shows a web-based configuration interface. At the top, there are three password fields: 'Current Password' with the value '6000', 'New Password' with '1234', and 'Repeat New Password' with '1234'. Below these are buttons for 'Update Password' and 'Hide password'. A 'Backlight' field is set to '12', with a note 'Range 0-120, 0 to disable backlight'. A 'Rated Load' dropdown is set to 'Power', and a numerical input field contains '376000' with a 'View' button and a range note 'Range: 8000-115000000'.

Advanced

Energy Type: The energy type can either be selected as Fundamental or Fundamental+Harmonics

Energy Reading: This can be set to either Primary or Secondary, where Primary displays the energy accumulation in terms of the Primary and Secondary will display the energy accumulation in terms of the secondary with resolution of up to 1Wh.

NOTE: When the energy reading mode is changed the energy will reset to 0 on the meter.

VAR/PF Convention: The VAR/PF convention can either be set to IEEE or IEC.

IEC the power factor is dependent on the direction of the real power flow

IEEE the power factor is dependent on the nature of the load, i.e. capacitive, inductive.

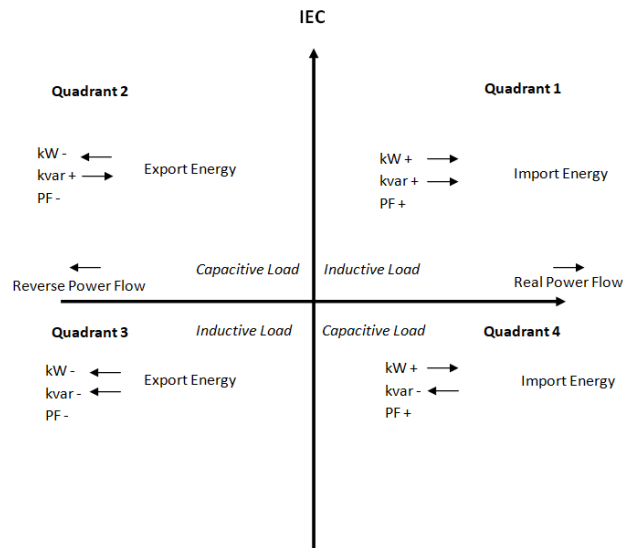

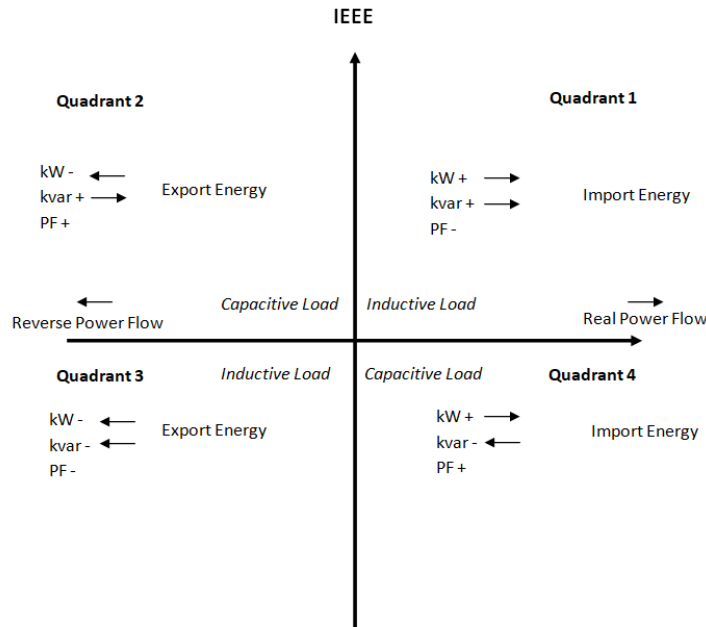

VAR Calculation Method: Can be selected as either True or Generalized

- True Method - Uses the Budeanu Concept to calculate the 'True' reactive power. This method generally takes the harmonic components to do the calculation instead of using the power vector triangle method. This method can be defined by the following by the following expression for single phase circuit:
- Generalized Method - Uses Fryze's concept to calculate the 'Generalized' reactive power. This method separates instantaneous current into two components, active and reactive currents.

Active current is calculated as:

$$i_a(t) = \frac{P}{V_{RMS}^2} v(t)$$

and reactive current as:

$$i_r(t) = i(t) - i_a(t).$$

Active and reactive powers are:

$$P = V_{\text{RMS}} \cdot I_a$$

$$Q_f = V_{\text{RMS}} \cdot I_r$$

where I_a and I_r represents RMS values of instantaneous active and reactive currents.

Optional Seal Configurations: Users can choose to seal the following parameters from this setting:

- Device Run Time
- DI Counters
- Communication Channel 1
- Communication Channel 2

Once all settings have been configured users can click on save and then perform a module reboot in order for the settings to be saved to the meter.

The screenshot shows the 'Advanced' settings page. It contains several sections:

- Energy Type:** A dropdown menu with 'Fund. + Harm.' selected.
- Energy Reading:** A dropdown menu with 'Primary' selected. Below it is a note: 'Note: Changing this option will reset energy.'
- var/PF Convention:** A dropdown menu with 'IEC' selected.
- var Calculation Method:** A dropdown menu with 'Generalized' selected.
- Optional Seal Configurations:** A section with four checkboxes: 'Device Run-Time' (unchecked), 'DI Counters' (unchecked), 'Communication Channel 1' (checked), and 'Communication Channel 2' (unchecked).

At the bottom left of the settings area is a green 'Save' button.

IO Settings

The Acuvim II supports 3 different I/O expansion modules that allow users add Digital Inputs, Digital Outputs, Relay Outputs, Analog Inputs, and Analog Outputs. There can be a max two of the same I/O module per meter, and will be represented by the I/O logic address 1 or 2. From the AXM-WEB2 interface users can configure the settings for these I/O modules.

AXM-IO1-1/2

The AXM-IO1 module supports 4 Digital Input channels, 2 Relay Output channels, and has a built in 24Vdc supply.

- Digital Input - Can be configured as either digital status or pulse counter.
 - DI Pulse Constant - If the DI is configured as pulse counter, then the DI pulse constant will represent how many pulses equals one count, i.e pulse constant is 2 that means that every 2 pulses the inputs reads the counter is increased by 1.
- Relay Output - Can be configured as Relay Control or Alarm Mode
 - Control Mode Output Mode - Can be configured as Latch or Momentary where users can manually turn on/off relay
 - Latch - Manually turn on/off relay
 - Momentary - Manually turn on relay for a short moment of time, the RO On time range is from 50-3000ms
 - Alarm Mode - The relay can be configured to trigger based on the alarm settings of the meter.

AXM-IO1-1 Enabled

DI 1 Type	DI 2 Type	DI 3 Type	DI 4 Type	DI 5 Type	DI 6 Type
<input type="radio"/> Status <input checked="" type="radio"/> Counter	<input type="radio"/> Status <input checked="" type="radio"/> Counter	<input checked="" type="radio"/> Status <input type="radio"/> Counter	<input type="radio"/> Status <input checked="" type="radio"/> Counter	<input checked="" type="radio"/> Status <input type="radio"/> Counter	<input type="radio"/> Status <input checked="" type="radio"/> Counter

RO Type
 Relay Control
 Alarm

RO Relay Control Output Mode
 Latch
 Momentary

RO ON Time
50 ms

DI Pulse Constant
1 Pulse = 1

AXM-IO2-1/2

The AXM-IO2 module supports 4 Digital Input channels, 2 Digital Output channels, and 2 Analog Output channels.

- Digital Input - Can be configured as either digital status or pulse counter.
 - DI Pulse Constant - If the DI is configured as pulse counter, then the DI pulse constant will represent how many pulses equals one count, i.e pulse constant is 2 that means that every 2 pulses the inputs reads the counter is increased by 1.

The screenshot shows the configuration for AXM-IO2-1, which is currently 'Enabled'. It features four columns for DI 1 Type, DI 2 Type, DI 3 Type, and DI 4 Type. Each column has radio buttons for 'Status' and 'Counter'. Below these, there is a 'DI Pulse Constant' section with a text input field containing '2' and a 'Pulse = 1' button.

- Digital Output - Can be configured for Pulse or Alarm mode.
 - DO 1 Output - Users can select the type of energy pulse outputted from DO Channel 1
 - DO 2 Output - Users can select the type of energy pulse outputted from DO Channel 2
 - There are 4 types of energy that can be used for Energy Pulse Output:
 1. System Import Active Energy
 2. System Export Active Energy
 3. System Import Reactive Energy
 4. System Export Reactive Energy
 - Pulse Width - Users can configure the Energy pulse width, the range is from 20-1000ms
 - DO Active Energy Pulse Constant - Select the Pulse Constant for Active Energy Pulse, the range is from 1-60000
 - DO Reactive Energy Pulse Constant - Select the Pulse Constant for Reactive Energy Pulse, the range is from 1-60000

The screenshot shows the configuration for Digital Output (DO). It includes a 'DO Type' section with radio buttons for 'Energy Pulse' and 'Alarm'. Below are dropdown menus for 'DO 1 Output' (set to 'System Import Active Energy') and 'DO 2 Output' (set to 'System Export Active Energy'). A 'Pulse Width' field is set to '80' with a unit of 'ms'. At the bottom, there are two input fields for 'DO Active Energy Pulse Constant' and 'DO Reactive Energy Pulse Constant', both set to '5000', with a range of '1-60000'. A 'Calculate Pulse Constant' button is also present.

Pulse Constant Calculator

The pulse constant calculator allows users to determine the pulse constant value based on the amount of energy per pulse required. Users would first need to input the maximum primary power which is the CT1 value multiplied by the PT1 value.

Once entered in, users can then scroll down to the 'Primary 1 Pulse =' and enter the value that one pulse would represent, i.e. 1 pulse = 1kWh. Once this is configured, a secondary pulse value will be populated which is the required pulse constant value. Users can import this value to the pulse constant setting by clicking on the 'Set as Active Energy Constant' or 'Set as Reactive Energy Constant' button.

Calculate Pulse Constant

Primary Maximum Power: 400 kW(kvar)
Range: 0.001 - 400

PT1: 400.0 V CT1: 1000 A PT2: 400.0 V CT2: Rogowski Coil

Secondary Maximum Power: 0.4 kW(kvar) Output Energy Pulse Width: 80 ms Minimum Interval: 81 ms
Must be larger than 80

Secondary DO Constant
Max: 1 kWh(kvarh) = 55900.62111801242 Pulse Min: 1 kWh(kvarh) = 1 Pulse

Primary DO Constant
Max: 1 Pulse = 1000 kWh(kvarh) Min: 1 Pulse = 0.017888888888888888 kWh(kvarh)
Max: 1 kWh(kvarh) = 55.900621118012424 Pulse Min: 1 kWh(kvarh) = 0.001 Pulse

Primary 1 Pulse = 1 kWh(kvarh)
Range: 0.017888888888888888 - 1000

Primary 1 kWh(kvarh) = 1 Pulse
Range: 0.001 - 55.900621118012424

Secondary 1kWh(kvarh) = 1000 Pulse
Range: 1 - 55901

Buttons: Set as Active Energy Constant, Set as Reactive Energy Constant, Close

AXM-WEB2 for Acuvim II Series Power Meter

- Analog Output - There are two analog output channels that users can configure.
 - AO1 Slope - select the slope value, the range is from 1-3
 - AO 1 Input Range 1 - Enter in the starting range for the Analog Output
 - AO 1 Input Range 2/3/4 - Enter in the ending range for the Analog Output
 - AO 1 Output Range 1 - Enter in the analog output signal
 - AO 1 Output Range 2/3/4 - Enter in the ending analog output signal.

NOTE: The analog output range can be a 4-20mA, 0-20mA, 0-5V, 1-5V signal depending on the model of the I/O, either voltage or current model.

The interface displays a graph for the Analog output signal according to the input range that has been configured.

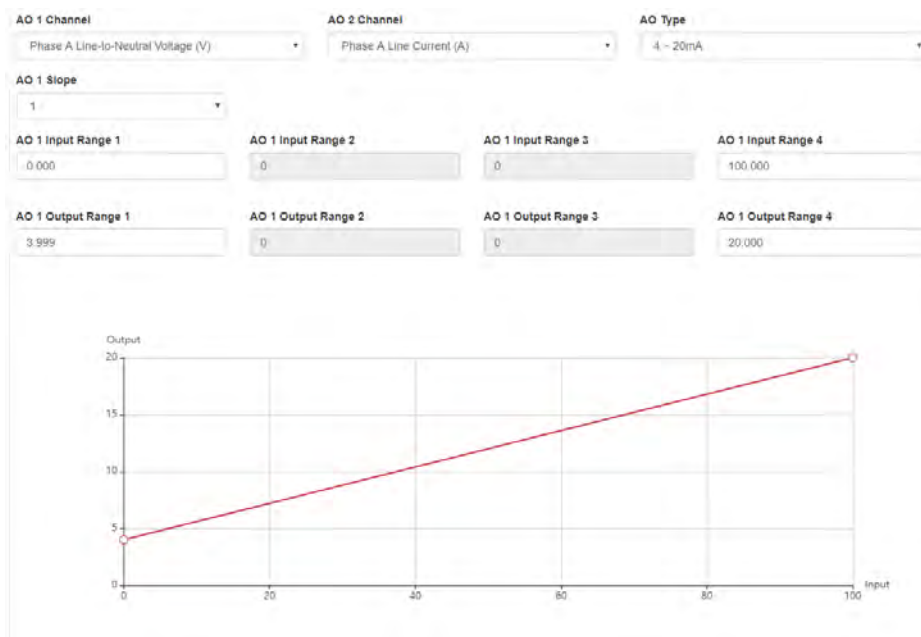

Similar to Analog Output channel 1, the second analog output channel can also be configured in the same manner from the web interface.

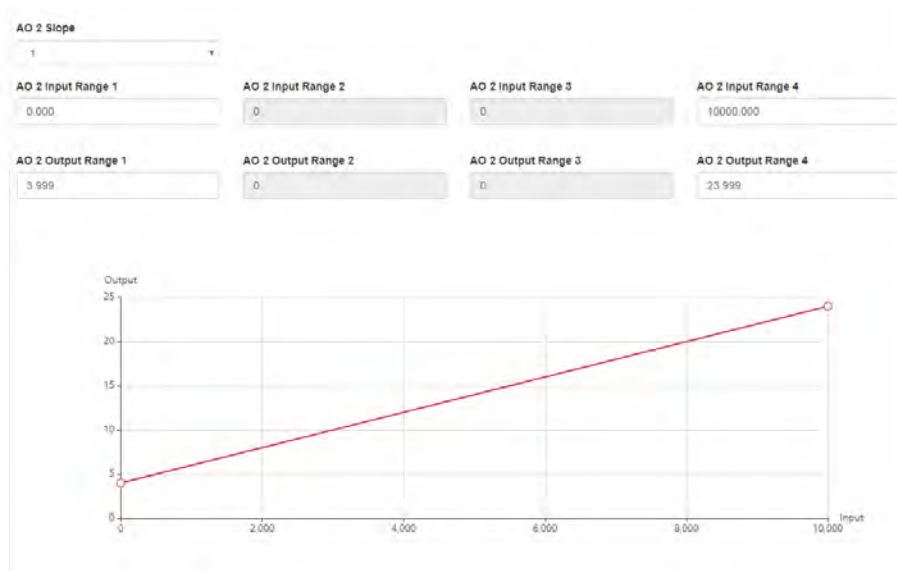

AXM-IO3-1/2

The AXM-IO3 module supports 4 Digital Input channels, 2 Relay Output channels, and 2 Analog Input channels.

- Digital Input - Can be configured as either digital status or pulse counter.
 - DI Pulse Constant - If the DI is configured as pulse counter, then the DI pulse constant will represent how many pulses equals one count, i.e pulse constant is 2 that means that every 2 pulses the inputs reads the counter is increased by 1.
- Relay Output - Can be configured as Relay Control or Alarm Mode
 - Control Mode Output Mode - Can be configured as Latch or Momentary where users can manually turn on/off relay
 - Latch - Manually turn on/off relay
 - Momentary - Manually turn on relay for a short moment of time, the RO On time range is from 50-3000ms
 - Alarm Mode - The relay can be configured to trigger based on the alarm settings of the meter.

AXM-WEB2 for Acuvim II Series Power Meter

- Analog Input - There are two analog input channels, users can select the type based on the type of module they have.
 - The AI types are:
 1. 4-20mA
 2. 0-20mA
 3. 1-5V
 4. 0-5V

AXM-IO3-1 Enabled

DI 1 Type Status Counter

DI 2 Type Status Counter

DI 3 Type Status Counter

DI 4 Type Status Counter

DI Pulse Constant

1 Pulse = 1

RO Type Relay Control Alarm Momentary

RO Relay Control Output Mode Latch Momentary

RO ON Time 50 ms

AI Type 4 - 20mA

IO Logic Address

From the WEB2 interface users have the option to change the logic addresses for the AXM-IO1 and AXM-IO3 modules. This is useful when users have two modules with the same logic address. For example if the user has two AXM-IO1-1 and attaches them both to the meter, the meter will only recognize one of the modules. This function allows the user to change the logic number from 1 to 2 where the user would then have one AXM-IO1-1 module and one AXM-IO1-2 module.

To change the logic address the module must be attached and installed on the back of the meter after the WEB2 communications module. Simply click on the drop down menu and select the corresponding logic address.

NOTE: The meter be physically power cycled in order for the logic address change to take effect.

AXM-IO2-2 Disabled

AXM-IO2-2 Disabled

IO Module 1 Type

AXM-IO1-1

AXM-IO1-2

None

IO Module 2 Type

AXM-IO1-1

Save

Alarm Settings

The Acuvim II meters supports over/under alarms for different metering parameters..From the WEB2 interface users can configure these alarms on the Alarm page. This page can be found by clicking on 'Settings' and selecting the 'Alarm' tab.

The meter supports up to 16 Alarm channels that users can monitor when the configured parameter goes over or under the alarm threshold. If users have extended I/O modules attached to the meter, digital outputs (DO) and relay outputs (RO) can be triggered upon alarm condition and used to activate external devices such as a buzzer, light, etc.

Alarm Enable: The alarm function can be enabled or disabled

Backlight Flash Trigger: If enabled, when an alarm is triggered the backlight of the Acuvim II meter display will flash during the alarm event.

Steps to setup alarm channels:

- To configure an alarm channel, enable the preferred alarm channel(s).
- Select the required parameter for the alarm channel under the 'Parameter' column.
- Choose the required setpoint and then select the condition for the alarm, i.e greater than (>), less than (<), or equal to (=).
- Users have the ability to set a delay for the alarm trigger, the range is from 0-30000 ms.
- Users can use the 'AND' function to trigger an alarm event when two conditions have been met.

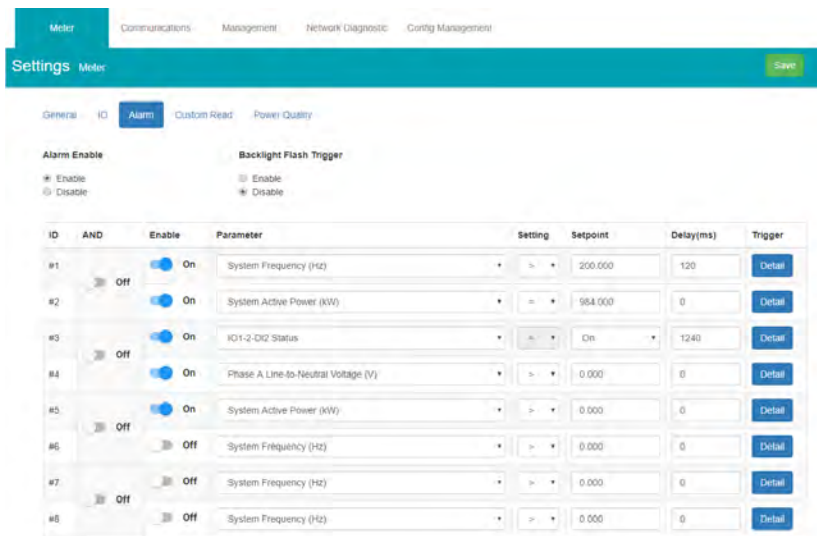

AXM-WEB2 for Acuvim II Series Power Meter

- If extended IO modules are being used, users can click on the detail tab to configure the digital output and relay outputs to be triggered when an alarm is triggered.

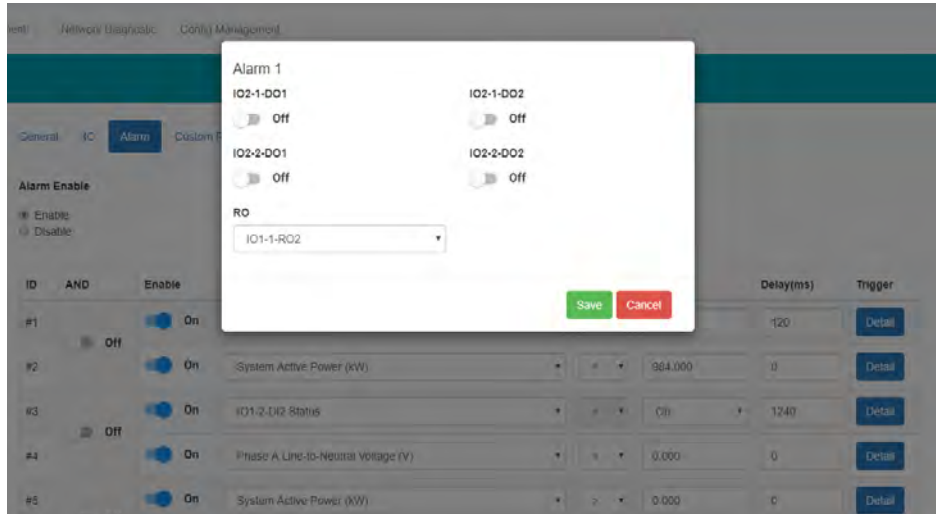

Once all alarm settings are configured, user must click on 'Save' and then reboot the communications module in order for the settings to be saved.

Custom Read

The Acuvim II meter supports a custom read function which allows users to customize a block of registers within the Acuvim II meter using different parameters (i.e. Basic metering, THD, Energy, etc) as well as different data types for the parameters (i.e. Int, float, etc). There is a total of 64 bytes that users have to create their customized register block.

NOTE: The Custom Read Function is only available in meters with firmware version 3.51 and higher.

The window on the left under 'Not Selected' are the list of parameters available for the custom read block. Users can choose between different parameters by clicking on the drop down menu under 'Parameter Type'. The available parameter types include:

- Real-Time Metering
- Demand
- Energy
- THD
- Sequence

Chapter 10: Web Interface Readings and Parameter Settings

- Phase Angles
- DI Counter
- AO/AI value

Each of these parameter types are available in different data types, such as integer (int), float, and double-word. Users may select the data type for each parameter from this drop down menu.

Users can select the parameters and click on the '>' button to add the parameters to the 'Selected' window. The parameters can be removed from the register block by clicking on the '<' button, and can clear the entire block by selecting the 'Clear' button.

As users add and remove parameters, there is a 'Bytes Used' and 'Bytes Remaining' value that lets users know how much space is left in the customized register block.

The screenshot displays the 'Settings Meters' web interface. At the top, there are navigation tabs: 'Meter', 'Communications', 'Management', 'Network Diagnostic', and 'Config Management'. Below this is a 'Settings Meters' header with a 'Save' button. The main content area has tabs for 'General', 'IO', 'Alarm', 'Custom Read', and 'Power Quality'. The 'Custom Read' tab is active. Under 'Parameter Type', a dropdown menu is set to 'Real-Time Metering (int)'. There are two columns of parameter lists: 'Not selected' and 'Selected'. The 'Not selected' list includes parameters like 'Phase B Line-to-Neutral Voltage (int)', 'Phase C Line-to-Neutral Voltage (int)', 'Phase A-B Line-to-Line Voltage (int)', 'Phase B-C Line-to-Line Voltage (int)', 'Average Line-to-Line Voltage (int)', 'Phase A Line Current (int)', 'Phase B Line Current (int)', 'System Average Line Current (int)', 'System Neutral Current (int)', 'Phase A Active Power (int)', and 'Phase B Active Power (int)'. The 'Selected' list includes parameters like '3200H - System Frequency (int)', '3201H - Phase A Line-to-Neutral Voltage (int)', '3204H - Average Line-to-Neutral Voltage (int)', '3207H - Phase C-A Line-to-Line Voltage (int)', '3208H - Phase C Line Current (int)', '434BH - IO1-1-DI2 Counter (int)', '434FH - IO1-1-DI4 Counter (int)', '4353H - IO1-1-DI6 Counter (int)', '4357H - IO2-1-DI2 Counter (int)', '4359H - IO2-1-DI3 Counter (int)', and '435BH - IO2-1-DI4 Counter (int)'. Between the lists are '>', '<', and 'Clear' buttons. At the bottom, it shows 'Bytes Used 62' and 'Bytes Remaining 2', along with a 'Custom Reading Table' button and a 'Save' button.

Once the block is configured, users can click on 'Save'.

A copy of the custom read register block can be viewed by selecting 'Custom Reading Table'. The table can be downloaded as a csv file by clicking on 'Export Table'.

AXM-WEB2 for Acuvim II Series Power Meter

Custom Reading Table

Description	Data Type	Start Address	Reg Number
System Frequency	int	6A00H	1
Phase A Line-to-Neutral Voltage	int	6A01H	1
Average Line-to-Neutral Voltage	int	6A02H	1
Phase C-A Line-to-Line Voltage	int	6A03H	1
Phase C Line Current	int	6A04H	1
IO1-1-DI2 Counter	int	6A05H	2
IO1-1-DI4 Counter	int	6A07H	2
IO1-1-DI6 Counter	int	6A09H	2
IO2-1-DI2 Counter	int	6A0BH	2
IO2-1-DI3 Counter	int	6A0DH	2
IO2-1-DI4 Counter	int	6A0FH	2

Export Table Close

Waveform Settings

The Acuvim IIW meters support a waveform capture feature where users can capture waveforms based on power quality events such as voltage sags, voltage swells and over currents. From the WEB2 interface, users can configure these settings by clicking on the 'Settings' tab and then selecting the 'Waveform' tab.

Rated Voltage: The rated voltage of the system should be entered here, the range is from 50-400V for wye systems or 50-690V for delta systems.

Voltage Swell

- Triggering Waveform Capture - Select enable to capture voltage swell events
- Threshold - Enter in the percentage of the voltage swell to be captured, the range is from 50-140%. For example if the rated voltage is 277V, and the voltage swell threshold is set for 110%. The swell event would be captured when the voltage is 110% above 277V, which is roughly 304V.

Voltage Sag

- Triggering Waveform Capture - Select enable to capture voltage sag events
- Threshold - Enter in the percentage of the voltage sag to be captured, the range is from 20-

Chapter 10: Web Interface Readings and Parameter Settings

100%. For example if the rated voltage is 277V, and the voltage sag threshold is set for 50%. The sag event would be captured when the voltage drops 50% below 277V, which is roughly 138V.

- Half-cycle Threshold - Enter in the half cycle threshold for the sag event, the range is from 4-200 half cycles.

Rated Current: The rated current for the over current should be entered here, the range will be dependent on the CT1 value configured on the meter. The rated current range will be from 50-100% of the CT1 value. For example if CT1 is configured as 1000A, then the rated current range for the Power Quality event is from 500A to 1000A.

Over Current

- Triggering Waveform Capture - Select enable to capture over current events
- Threshold - Enter in the percentage of the over current to be captured, the range is from 50-150%. For example if the rated current is 1000A, and the over current threshold is set for 50%. The over current event would be captured when the current is 500A.

The screenshot displays the 'Settings Meter' web interface with the 'Power Quality' tab selected. The configuration is as follows:

- Rated Voltage:** 120 V (Range: 50 to 400)
- Voltage Swell:**
 - Threshold: 130 % (Range: 50 to 140)
 - Triggering Waveform Capture: Disable, Enable
- Voltage Sag:**
 - Threshold: 20 % (Range: 20 to 100)
 - Half-cycle Threshold: 10 Half-cycle (Range: 4 to 200)
 - Triggering Waveform Capture: Disable, Enable
- Rated Current:** 1000 A (Range: 500 to 1000)
- Over Current:**
 - Threshold: 100 % (Range: 50 to 150)
 - Triggering Waveform Capture: Disable, Enable

AXM-WEB2 for Acuvim II Series Power Meter

If user are using external I/O modules, the waveform capture can be triggered by the Digital Inputs Status. The DI can trigger the waveform by the following:

- From Status Off to On
- From Status On to Off
- Any Change

The DI triggering can be disabled is users do not require it to trigger the waveform capture.

DI Trigger Waveform Capture			
IO1-1-DI1 Disabled Disabled From Off to On From On to Off Any Change	IO1-1-DI2 Disabled	IO1-1-DI3 Disabled	IO1-1-DI4 Disabled
IO2-1-DI1 Disabled	IO1-1-DI6 Disabled	IO2-1-DI3 Disabled	IO2-1-DI4 Disabled
IO3-1-DI1 Disabled	IO3-1-DI2 Disabled	IO3-1-DI3 Disabled	IO3-1-DI4 Disabled

Save

10.6.2 Communications

The communication setting web page will allow the user to configure settings related to the Ethernet networks and the Wireless network. The functions and protocols that the AXM-WEB2 module supports can be configured by selecting the corresponding tab such as Emails, Time/Date , Datalog, AcuCloud Post for communicating with the AcuCloud software, BAC-net-IP, SNMP, IEC61850, and DNP3.

Network

The first page the user will see after selecting the Communications option under the Settings tab is the Network page. The network settings allow users to configure all network related settings including both Ethernet 1 and Ethernet 2 as well as WiFi.

RSTP Protocol

The AXM-WEB2 supports the RSTP protocol where users can daisy chain the Ethernet ports on the AXM-WEB2 module to a network switch.

Users can configure the meters IP manually or by setting the DHCP set as Auto.

Chapter 10: Web Interface Readings and Parameter Settings

NOTE: When the RSTP is enabled users will not be able to configure Ethernet 1 and Ethernet 2, there is only 1 IP per meter using RSTP protocol.

Network Topology

Users can daisy chain up to 32 devices using the RSTP protocol. This can cut down the amount of network switches required in different applications and allows the use of 1 network switch/router to be used with up to 32 devices. Each device can be accessed by configuring a unique IP address or having the IP addresses assigned automatically by the network.

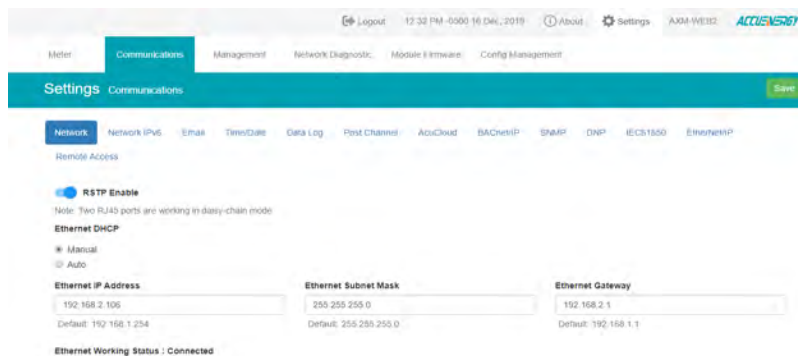
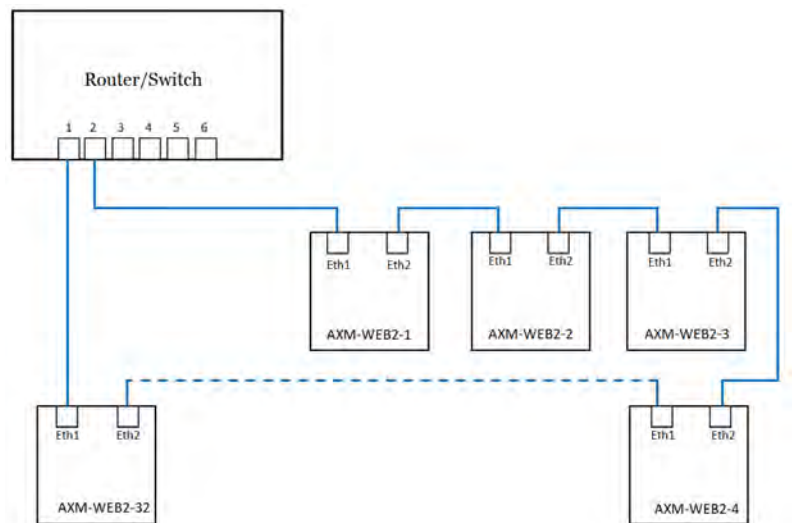

V: 1.10 Revised: January 2020

73

Network Settings

The settings for the Ethernet 1 and Ethernet 2 are as followed:

Ethernet 1 DHCP: Select 'Manual' to manually configure the IP address to access the meter. If set to 'Manual', you'll also need to set the Subnet Mask and Gateway. By default the IP address for ETH1 will be 192.168.1.254

Select 'Auto' to have the meter assigned a IP address automatically. With this selection the Subnet Mask, and Gateway will also be automatically assigned.

Note: After changing DHCP to Auto, check the display of the meter(N02 NET Settings) to obtain the new IP address that has been assigned. The new IP address will be displayed only after a module reboot is performed and completed.

IP Address: If the DHCP is configured to Manual, the IP address can be configured from this page. Default is 192.168.1.254

Subnet Mask: If the DHCP is configured to Manual, the Subnet Mask can be configured from this page. Default is 255.255.255.0

Gateway: If the DHCP is configured to Manual, the Gateway can be configured from this web page. Default is 192.168.1.1

The status of the Ethernet 1 port will display if it is connected or disconnected.

Ethernet 2 DHCP: By default the Ethernet 2 port is configured to have its DHCP set to 'Auto'. If configured to 'Manual' the default Manual IP address is 192.168.1.253. Users can configure the IP address to any IP once the DHCP is configured for 'Manual', users will also need to set the Subnet Mask and Gateway if using this method.

NOTE: The IP address of the Ethernet 2 can be found page N12 of the NET Settings. The Acuvim II protocol setting must be configured to WEB2 to view this from the meters NET settings.

IP Address: By default the IP address is configured by DHCP, this field will be grayed out. If the DHCP is configured to Manual, the IP address can be configured from this page.

Subnet Mask: If the DHCP is configured to Manual, the Subnet Mask can be configured from this page.

Gateway: If the DHCP is configured to Manual, the Gateway can be configured from this web page.

The status of the Ethernet 2 port will display if it is connected or disconnected.

Chapter 10: Web Interface Readings and Parameter Settings

The screenshot displays the web interface for AXM-WEB2, specifically the 'Settings' page under 'Communications'. The interface includes a top navigation bar with 'Logout', '12:35 PM - 05:00 16 Dec. 2019', 'About', 'Settings', 'AXM-WEB2', and 'ACCUENERGY'. Below this is a secondary navigation bar with 'Meter', 'Communications', 'Management', 'Network Diagnostic', 'Module Firmware', 'Meter Firmware', and 'Config Management'. The main content area is titled 'Settings Communications' and features a 'Save' button. Under the 'Network' tab, there are sub-tabs for 'Network IPv5', 'Email', 'Time/Date', 'Data Log', 'Post Channel', 'Waveform Post', 'AutoCloud', 'BACnetIP', 'SNMP', 'DNP', and 'IEC61850'. The 'Ethernet 1 DHCP' section is active, showing 'Ethernet 1 IP Address' set to 192.168.1.161, 'Ethernet 1 Subnet Mask' set to 255.255.255.0, and 'Ethernet 1 Gateway' set to 192.168.1.1. Below this, 'Ethernet 2 DHCP' is also shown with 'Ethernet 2 IP Address' set to 192.168.1.6. Both Ethernet ports are shown as 'Connected'.

WiFi Enabled: Select the Enable or Disable communication through WiFi.

WiFi Mode: The WiFi can be configured to work in two modes just like any other WIFI device. It can be configured as either Access Point(AP) or Station mode.

Access Point: Default configuration for AXM-WEB2. The AXM-WEB2 will act as a wireless access point and will allow other wireless devices to connect and access the AXM-WEB2.

- In Access Point mode, users can configure the SSID, Network Key and IP of the AXM-WEB2 module as well as the DHCP DNS servers.

Station: The AXM-WEB2 will behave like a wireless client and bridge to another wireless network that is available.

- In Station mode, users can select the Wireless network to connect to under the "Connect to SSID" setting. Click on "Select from Available Networks" and enter the Network Key for the wireless network that the AXM-WEB2 will bridge to.
- If users are connecting to an open Wireless network that is not password protection, the password field can be left blank.
- The AXM-WEB2 also supports Enterprise WiFi, where users can connect using an enterprise level WiFi network which is common in many colleges/universities, hospitals, etc. When attempting to connect to an enterprise level WiFi network the interface will show options to connect to the network with a username and password.

AXM-WEB2 for Acuvim II Series Power Meter

The screenshot shows the WiFi configuration page. At the top, 'WiFi Mode' is set to 'Station'. Below that, 'Connect to SSID' is 'AcuRev2000_TEST'. The 'Username' field is empty, and the 'Password' field is also empty. Under 'WiFi DHCP', the 'Manual' radio button is selected. The 'WiFi IP Address' is '192.168.1.10', 'WiFi Subnet Mask' is '255.255.255.0', and 'WiFi Gateway' is '192.168.1.1'. There are 'Save' buttons for each section.

In station Mode the DHCP can configured as either manual or auto.

- If manual, users can configure the IP, Subnet Mask and Gateway and DNS Servers.
- If auto, users can check the meter's display to get the IP address and all other network configurations assigned by the wireless network. The user can also configure the DNS servers if the DHCP is set to Auto.

NOTE: The WiFi IP address for the AXM-WEB2 will be in parameter N11 of the NET settings. The Acuvim II protocol setting must be configured to WEB2 to view this from the meters NET settings.

DNS Server 1: Enter the address of DNS server 1 in this field.

DNS Server 2: Enter the address of DNS server 2 in this field.

HTTPS Port: Enter the HTTPS port number of the meter. By default, this setting is configured to 443. The range can be from 6000 to 9999.

NOTE: This setting should never be configured to 80. Enable the HTTP Enable configuration to access the web interface at port 80.

HTTP Enable: Enable HTTP so the the AXM-WEB2 cab be accessed through the HTTP protocol, by default the HTTP port is 80 but it can be configured from 6000-9999.

Modbus TCP Port: Enter the Modbus port number of the meter. By default, this setting is configured to 502. The range can be from 2000 to 5999.

Fast Read Mode Enable: Selecting Enable allows the user to read the real time parameters at 100ms.

- **Frequency Adjustment:** Allows users to control the rate of change of frequency. The range can be set from 1.00-5.00 Hz/s, by default this is set for 1 Hz/s.
 - The minimum range is 45Hz and the max range is 65Hz, any frequency outside of the range will not have the frequency adjustment applied.

Chapter 10: Web Interface Readings and Parameter Settings

NOTE: Frequency Adjustment is only available when the meter is in Fast Read Mode.

NOTE: When Fast Read mode is enabled, all functions except Modbus and the Web server are disabled.

Default: 502, Range: 2000-5999

Fast Read Mode Enable

Disable
 Enable

The meter will run into Fast Read Mode after reboot
All functions except modbus reading will be disabled

Frequency Adjustment

Disable
 Enable

Change Rate

1.00 Hz

Range: 0.01-5.00

Minimum Adjustment Value

-45 Hz

Range: -45-05

Maximum Adjustment Value

-65 Hz

Range: -45-65

Proxy Server Enable: Select enable to allow for forwarding of data log files to pass through the Proxy server first and then the data post server. IE. AcuCloud.

After making any changes on the network settings page, click 'Save'. Users will be prompted to reboot the AXM-WEB2 immediately or later. If later is chosen the AXM-WEB2 will need to be rebooted from the 'Management' page in order for the settings to take effect.

WiFi Enable

Disable
 Enable

WiFi Mode

Station

Connect to SSID [Add New Network](#)

AcuPy-2000_TEST

note: maximum 32 characters

Network Key

note: minimum 8 characters and maximum 63 characters

WiFi DHCP

Auto

WiFi IP Address

192.168.2.212

WiFi Working Status: Connected

DHCP DNS Server 1

8.8.8.8

Default: 8.8.8.8

DHCP DNS Server 2

8.8.4.4

Default: 8.8.4.4

HTTP Enable

Disable
 Enable

HTTP Port

443

Default: 443, Range: 6005-8999

Fast Read Mode Enable

Disable
 Enable

Modbus TCP Port

502

Default: 502, Range: 2000-5999

HTTP Proxy Server Enable

Disable
 Enable

Save

AXM-WEB2 for Acuvim II Series Power Meter

IPv6

The AXM-WEB2 module supports IPv6 communication where users can use IPv6 to access the web interface as well as connect via SNMP protocol. The settings for IPv6 can be accessed by clicking on Settings and selecting the Communications tab. On the Communications page select the IPv6 tab to configure the settings.

IPv6 Enable: Enable to access the settings for IPv6

Ethernet DHCP: This can be set to manual or auto.

- When set to Manual, users must configure the IPv6 address, the Subnet Prefix Length, and the Gateway.
- When set to Auto, the network will assign an IPv6 address automatically.

Ethernet Link Local Address: Is an IPv6 address that is automatically configured on the device with prefix 'fe80' followed by the MAC address of the module.

Ethernet Status: Displays whether there is an Ethernet cable connected or disconnected.

The screenshot shows the 'Settings' page for 'Communications' in the AXM-WEB2 web interface. The 'Network IPv6' tab is selected. The page displays settings for two Ethernet ports:

- Ethernet 1:**
 - IPv6 Enable: Enabled
 - Ethernet 1 DHCP: Manual
 - Ethernet 1 IPv6 Link Local Address: fe80::aac3:8aff:fe20:29dc
 - Ethernet 1 IPv6 Address: 2001:db8::ecc3:8aff:fe70:9009
 - Ethernet 1 Subnet Prefix Length: 64
 - Ethernet 1 Gateway: 2001:db8::ecc3:8aff:fe70:9009
 - Ethernet 1 Working Status: Connected
- Ethernet 2:**
 - Ethernet 2 DHCP: Auto
 - Ethernet 2 IPv6 Link Local Address: fe80::ecc3:8aff:fe20:29dc
 - Ethernet 2 IPv6 Address: (empty field)

Email

The AXM-WEB2 supports the SMTP protocol where users can setup the email function to enable the meter to send emails based on a specific time interval or whenever there is an alarm or SOE event or a combination of both. The Email configuration page can be accessed by clicking on the 'Email' tab on the settings page. Users must know their SMTP server provider and details regarding their SMTP server, which can be provided by users' IT personnel.

There are three modes available for sending emails that the user can enable.

The first mode is '**Triggered Sending**' where emails are sent immediately when there is a new alarm, SOE, or waveform event.



The second mode is '**Timed Sending**' where users can receive emails at a certain period of time based on the time interval configured. The email will include the data that is selected to be sent.

The third mode is when both of the above are enabled.

To use this function the following settings need to be configured:

SMTP Enabled: Select 'Enable' to enable and to further configure the settings related to the SMTP function.

Start Time to Send Email: Select the date and time for when the emails should begin to send.

- Click on the  icon to configure the time and date.
- Click on the  icon in the bottom right to clear the time and date.

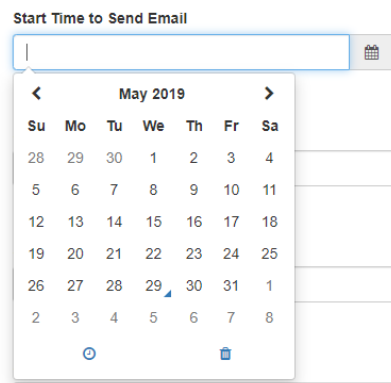

AXM-WEB2 for Acuvim II Series Power Meter

SMTP Port: Enter the port number associated with the SMTP server.

SMTP From: Enter a name or phrase which will appear to let you know who the mail is from. I.E. 'Technical Support'

SMTP Subject: Enter a subject line for the emails

Authentication: Users can have email authentication on or off. If authentication is on users will need to provide the SMTP username and password.

- **SMTP Username:** Enter the SMTP user name for the SMTP server set above.
- **SMTP Password:** Enter the SMTP user password for the username set above.
- **TLS/SSL:** Users have the option to send emails using TLS/SSL protocols

Authentication

- On
 Off

SMTP Username

note: maximum 40 characters

SMTP Password

note: maximum 32 characters

TLS/SSL

- On
 Off

SMTP To Address 1;2;3: Enter up to three recipients that you wish to have the email sent to in 'SMTP To Address 1', 'SMTP To Address 2' and 'SMTP To Address 3'.

Test Address 1,2,3: Test the if the email can be sent to 'SMTP To Address 1', 'SMTP To Address 2', 'SMTP To Address 3'.

NOTE: If the test address function fails, users can view the email post failure by clicking on the 'Details' option from the test post screen.

Chapter 10: Web Interface Readings and Parameter Settings

After configuring the above settings, the next step is to select the content for the emails.

The screenshot shows the 'Settings Communications' page with the 'Email' tab selected. The 'SMTP Enable' section has the 'Enable' radio button checked. The 'Start Time to Send Email' field is set to '11:37 AM -0400 8 Jul, 2019'. The 'SMTP Server' field contains 'ssl.digitalhosting.ca' and the 'SMTP Port' field contains '587'. The 'SMTP From' field is 'AXM-WEB2 User' and the 'SMTP Subject' field is 'Acuview II Data'. The 'Authentication' section has the 'On' radio button checked. There are three 'SMTP To Address' fields: 'test12@accuenergy.com', 'test Address 2', and 'test Address 3'. Each field has a 'Test Address' button below it.

The content of the emails can either be time based triggered or event based triggered.

For receiving emails on a time based under Enable Periodic Email Reporting:

Enter a time between 5-1440 mins in the Set time interval

- Check off the box beside the parameters for the content the user should receive.
 - **Metering Data:** Report on Real-time voltage, current, power and etc.
 - **Energy Data:** Report on energy parameters.
 - **Harmonics Data:** Report on the voltage and current harmonics from 2nd to 63rd.
 - **Sequence & Phase Angles:** Report on the positive, negative and zero components of the voltage and current waveform.
 - **Min/Max:** Report on the maximum and minimum statistics that the meter has recorded since the lifetime of the meter or from the last reset of the min/max statistics.
 - **Alarm:** Report of the alarm log.
 - **SOE Record:** Report of the SOE log.
 - **Waveform:** Report of the waveform log.

AXM-WEB2 for Acuvim II Series Power Meter

The user will receive an email with csv file attachment.

For receiving emails on a event based select either Alarm Event, SOE Record or Waveform Data under the Enable Real-time Email Reporting.

NOTE: Waveform Data is only available for Acuvim IIW model.

The user will receive an email with csv file attachment corresponding to the triggered event selected.

The screenshot shows a configuration page for email reporting. At the top, there is a section for 'Enable Periodic Email Reporting' with a 'Set time interval' dropdown set to '5' and a 'Range 5 - 1440' label. Below this is a section titled 'Include in the Periodic Email' with two columns of checkboxes: 'Metering Data', 'Energy Data', 'Harmonics Data', and 'Sequence & Phase Angles' on the left; and 'MinMax', 'Alarms', and 'SOE Records' on the right. All these checkboxes are checked. Below that is a section for 'Enable Real-time Email Reporting' with three checkboxes: 'Include Alarm Event', 'Include SOE Records', and 'Include WaveForm Data'. The first two are checked, and the last one is unchecked.

Time/Date

The device clock of the Acuvim II series meter can be set through the web interface of the AXM-WEB2 module. The AXM-WEB2 module also supports the NTP (Network Time Protocol) protocol so that the module can update the meter's device clock by synchronizing with a time server.



The module can sync with up to 3 time servers. If a time server is down, the module will synchronize with the second or third time server if they are configured.

The settings for the time and date can be found by clicking on the 'Settings' and selecting the 'Communications' tab. Users can select 'Time/Date' to configure the time settings.

The following must be configured to set the time/date and NTP settings:

NTP Enabled: Select enable to further configure the settings related to the NTP (Network Time Protocol) function

Device Clock: Configure the date and time on the meter

- Click on the  icon to configure the date and time.
- Click on the  icon in the bottom right to clear the time and date.

Chapter 10: Web Interface Readings and Parameter Settings

Sync Time: Click on Force Update to have the AXM-WEB2 sync its time with the NTP server

NTP Server 1;2;3: Enter up to 3 NTP servers in the "NTP Server 1", "NTP Server 2" and "NTP Server 3" fields.

Examples of North American SNTP servers are:

0.us.pool.ntp.org

1.us.pool.ntp.org

2.us.pool.ntp.org

3.us.pool.ntp.org

For more NTP servers based on region, visit the following site:

<http://www.pool.ntp.org/en/>

Time Zone: Select the time zone the meter is in or the time zone in which you would like the meter's time to be synchronized to from the drop down list. Users can also select the timezone by clicking on the region in the map.

Click 'Save' after configuring the time settings. Users will be prompted to reboot the AXM-WEB2 immediately or later. If later is chosen the AXM-WEB2 must be rebooted from the 'Management' page in order for the settings to take effect.

The screenshot displays the 'Time/Date' configuration page of the AXM-WEB2 interface. At the top, there is a navigation menu with tabs for Network, Network IPv6, Email, Time/Date (selected), Data Log, Post Channel, Waveform Post, AcuCloud, BACnet/IP, SNMP, DNP, and IEC61850. Below the menu, there are sub-sections for EtherNet/IP and Remote Access. The main configuration area includes:

- NTP Enable:** Radio buttons for 'Disable' and 'Enable' (selected).
- Device Clock:** A text field showing '3:49 PM -0500 16 Dec, 2019' and a 'Force Update' button.
- NTP Server 1, 2, and 3:** Three text input fields. The first field contains '0.us.pool.ntp.org'. Each field has a note below it: 'Note: Maximum 40 characters'.
- Time Zone:** A dropdown menu currently set to 'America/Toronto (EST)'. Below the dropdown is a world map with a blue pin indicating the selected location in North America.

AXM-WEB2 for Acuvim II Series Power Meter

Data Log

The AXM-WEB2 supports logging data onto its on board memory.

The module supports three loggers for different parameters and requirements.

The data can be downloaded as a .csv file from the datalog page in the logs section or by using a HTTP/FTP client.

Logger Enable: To use the data log function to log the data onto the module, select 'Enable' to view and configure the settings that are applicable.

Post Channel: Select the channel to push the datalog to. Only an enabled post channel can be selected here. A post channel can be enabled in the 'Post Channel' tab on the settings page.

Log Param Type: Users can select the type of parameters they wish to log into logger.

Users can use the '>' button to add selected parameters into the data log, and use the '<' button to remove selected parameters from the data log. Users can also use the 'All' or 'Clear' buttons to add all or clear all parameters to and from the data log. The supported parameter types include real-time readings, energy readings, demand readings, power quality readings and I/O readings.

Log Param Type

Not selected

- Line-to-Line Voltage
- Neutral Current
- Reactive Power
- Apparent Power
- Load Type

Selected

- Line-to-Neutral Voltage
- Line Current
- Active Power
- Power Factor
- Frequency
- Import Active Energy
- Total Active Energy
- Active Power Demand
- Voltage THD
- Current THD



Chapter 10: Web Interface Readings and Parameter Settings

Log Param Type Detail: This setting allows users to modify what values they see in the data log. Users can select the following parameter details:

- Instantaneous
- Minimum
- Maximum
- Average

Only the 'Real-time' and 'Demand' parameters support the minimum, maximum and average parameter type details. All other parameter types such as Energy, Power Quality, and IO only support the instantaneous values displayed in the the data log.

The image below describes how these parameter details function in the data log. The image of the csv file below depicts a sample of a data log where the data is logged every 5 minutes. The first few columns are highlighted showing the Phase A Line-Neutral voltage.

- Column B highlighted in yellow shows the instantaneous value for Phase A voltage at every 5 minute interval.
- Column C highlighted in green shows the minimum value for Phase A voltage between each 5 minute interval.
- Column D highlighted in red shows the maximum value for Phase A voltage between each 5 minute interval.
- Column E highlighted in orange shows the average value for Phase A between each 5 minute interval.

	A	B	C	D	E	F	G	H	I	J	K	L
1	Time	V1	V1_MIN	V1_MAX	V1_AVG	V2	V2_MIN	V2_MAX	V2_AVG	V3	V3_MIN	V3_MAX
2	2019-06-20 9:55	120.067	120.067	120.077	120.0714667	120.084	120.078	120.087	120.084	120.091	120.09	120.096
3	2019-06-20 10:00	120.072	120.032	120.076	120.0728667	120.079	120.077	120.087	120.081	120.091	120.09	120.094
4	2019-06-20 10:05	120.068	120.01	120.076	120.0720667	120.084	120.08	120.086	120.083	120.093	120.091	120.094
5	2019-06-20 10:10	120.073	120.065	120.078	120.0707143	120.083	120.079	120.088	120.083	120.092	120.091	120.094
6												
7												
8												
9												
10												

AXM-WEB2 for Acuvim II Series Power Meter

Timestamp Format: Select the format of the timestamp for the data that is logged. The format for the timestamp can be based on the Local Time, UTC Seconds or based on ISO8601 Format.

Log File Name Format: Select the format of the log file name for the data that is logged. The format for the log file name can be based on the UTC timestamp or based on Time Interval Format.

Log Interval: Select how frequently the meter will log data to the file that will be uploaded to the server from the drop down list. The logging interval can be from 1 second to 1 month. The minimum time interval option is according to the selected parameter.

- The Real-time & IO's min Log Interval is 1 sec
- The Energy's min Log Interval is 15 sec
- The Demand & Power Quality's min Log Interval is 1 min

NOTE: If selected parameters are Real-time and I/O, the min log interval is 1 sec. If selected parameters are Real-time and Energy, the min log interval is 15 sec.

Post File Length: Select how frequently the log file will be uploaded to the server from the drop down list. The log file length can be from 1 minute to 1 month.

Log File Name Prefix: Provide a name for the log file posted to post channel which will be appended to the beginning of the log file if "Time Interval Format" is selected as the Post File Name Format. By default "logger1" will be appended to the beginning of the log file.

Local Log File Length: Select the length of the local log file as 1 hour, 1 day, 7 days or 1 month of data from the drop down list.

Local Log File Name Prefix: Provide a name for the local log file which will be appended to the beginning of the log file if "Time Interval Format" is selected as the Post File Name Format. By default "logger1" will be appended to the beginning of the log file.

NOTE: The Post File Length and Local Log File Length must be less than or equal to the log interval selected.

Chapter 10: Web Interface Readings and Parameter Settings

Settings Communications Save

Network Network IPv6 Email Time/Date **Data Log** Post Channel Waveform Post AcuCloud BACnet/IP SNMP DNP IEC61850

Remote Access

Logger1 Logger2 Logger3

Logger1 Enable

Disable
 Enable

Post Channel

None of Post Channels are enabled. Please set up Post Channel configurations at first

Log Param Type

Real-Time

Not selected

- Line-to-Line Voltage
- Neutral Current
- Reactive Power
- Apparent Power
- Load Type

Selected

- Line-to-Neutral Voltage
- Line Current
- Active Power
- Power Factor
- Frequency

Log Param Type Detail

Instantaneous Value
 Minimum Value
 Maximum Value
 Average Value

Timestamp Format

Local Time String (e.g., 2017-01-01 10:00)
 UTC Seconds (Number of seconds that have elapsed since 1970-01-01 00:00:00 Coordinated Universal Time)
 ISO8601 Format (e.g., 2017-01-01T10:00:00)

Log File Name Format

UTC Timestamp (e.g., logger1-1484578000.csv)
 Time Interval Format (e.g., logger1-2017-01-10T12-00-30day.csv)

Log Interval 1 minute **Log File Length** 1 hour **Log File Name Prefix** logger1
e.g., logger1-2017-10-01T09-45-1day.csv

Local Log File Length 1 day **Local Log File Name Prefix** logger1
e.g., logger1-2017-10-01T09-45-1day.csv

SFTP Enable

Disable
 Enable

AXM-WEB2 for Acuvim II Series Power Meter

SFTP Enable: To download the logged data from the module using a FTP client, select Enable. The log file will then be available to be downloaded using a FTP client using the following credentials:

Host: *sftp://IPAddressofthemet*

Username: *sftpuser*

SFTP Password: *accuenergy*

Port: 22

By default the password for retrieving the backup log files is **accuenergy**. The user can configure any password or can reset to the default of accuenergy by clicking on the "Reset SFTP Password".

NOTE: *After enabling the SFTP function the user must reboot the communication module in order to access the data logs with the default password of 'accuenergy'.*

Click 'Save' after changing any settings. Users will be prompted to reboot the AXM-WEB2 immediately or later. If later is chosen the AXM-WEB2 must be rebooted from the 'Management' page in order for the changes to take effect.

The screenshot shows a web interface for configuring SFTP settings. At the top, there is a label "SFTP Enable" followed by a red "unsaved changes" indicator. Below this are two radio buttons: "Disable" and "Enable", with "Enable" selected. Underneath is a section for "SFTP Password" with a text input field containing six dots and a blue "Reset SFTP Password" button. A note below the input field states "note: maximum 12 characters". At the bottom of the form is a green "Save" button.

Post Channel

The AXM-WEB2 supports the HTTP and FTP Post functions to send data from the meter to a HTTP/FTP server. The AXM-WEB2 can post .csv files to three different HTTP or FTP servers using HTTP Post or FTP Post.

In the case when there is no connection to the server, the AXM-WEB2 will store the posts and send it out after the connection is restored. A maximum of 3000 files will be buffered on module.

Chapter 10: Web Interface Readings and Parameter Settings

The Clear Post Channel Logs button will allow users to clear the buffered files on meter.

The AXM-WEB2 can post data to a server at intervals of time ranging from 1 minute to 1 month.

The settings for configuring the post channels to post the data can be found by clicking on 'Settings' and then selecting 'Communications' tab. Click "Post Channels" to configure any of the three post channels.

Post Channel 1 Enable: Enable the Post Channel 1 in order to configure the settings needed to post data via the HTTP(S)/FTP post functions

Post Method: Select the method for posting the files, the user can choose HTTP/HTTPS or FTP

Post Name Fixed: This configuration needs to be enabled in order for user to control the name of the file that will be posted. Otherwise file name will be based on the Log File Name Format configuration from the Data Log settings

Post File Name: Users can enter a name for the file that will be posted as if 'Post Name Fixed' is enabled

If the HTTP/HTTPS post method is selected:

HTTP/HTTPS URL: Enter the URL for the HTTP/HTTPS server. The URL needs to begin with the prefix http:// or (https://)

HTTP/HTTPS Port: Enter the port number the server will be listening on

HTTP/HTTPS Meter ID: Enter a name or description for the meter to be identified on the server

If the FTP post method is selected:

FTP URL: Enter the URL for the FTP server. The URL needs to begin with the prefix ftp://

FTP Port: Enter the port number the server will be listening on

FTP Username: Enter the username required to log into the FTP server

FTP Password: Enter the password required to log into the FTP server

NOTE: The 'TEST Post Channel' button should only be utilized after clicking the 'Save' button otherwise a fail response will be observed. If a fail response occurs after clicking 'Save' confirm the network settings or credentials for the server.

AXM-WEB2 for Acuvim II Series Power Meter

Click 'Save' after changing any settings. Users will be prompted to reboot the AXM-WEB2 immediately or later. If later is chosen the AXM-WEB2 must be rebooted from the 'Management' page in order for the settings to take effect.

The screenshot shows the web interface for the AXM-WEB2 power meter. The top navigation bar includes 'Meter', 'Communications', 'Management', 'Network Diagnostic', 'Module Firmware', 'Meter Firmware', and 'Config Management'. The 'Settings' page is active, with 'Communications' selected. The 'Post Channel' tab is highlighted, showing settings for Post Channel 1, 2, and 3. The 'Post Channel 1 Enable' section has 'Enable' selected. The 'Post Method' is set to 'HTTP / HTTPS'. The 'Post Name Fixed' toggle is 'Enable'. The 'Post File Name' field contains 'WEB2'. The 'HTTP / HTTPS URL' is 'http://test', 'HTTP / HTTPS Port' is '123', and 'HTTP / HTTPS Meter ID' is 'Post_Channel_1'. There are buttons for 'Test Post Channel 1' and 'Clear Test Channel 1 Logs'.

Select the Post Channel 2 tab to configure the settings for post to a second server.

Post Channel 2 Enable: Enable the Post Channel 2 in order to configure the settings needed to post data via the HTTP(S)/FTP post functions

Post Method: Select the method for posting the files, the user can choose HTTP/HTTPS or FTP

Post Name Fixed: This configuration needs to be enabled in order for user to control the name of the file that will be posted. Otherwise file name will be based on the Log File Name Format configuration from the Data Log settings

Post File Name: User can enter a name for the file that will be posted as if Post Name Fixed is enabled

Chapter 10: Web Interface Readings and Parameter Settings

If the HTTP/HTTPS post method is selected:

HTTP/HTTPS URL: Enter the URL for the HTTP/HTTPS server. The URL needs to begin with the prefix http:// or (https://)

HTTP/HTTPS Port: Enter the port number the server will be listening on

HTTP/HTTPS Meter ID: Enter a name or description for the meter to be identified on the server

If the FTP post method is selected:

FTP URL: Enter the URL for the FTP server. The URL needs to begin with the prefix ftp://

FTP Port: Enter the port number the server will be listening on

FTP Username: Enter the username required to log into the FTP server

FTP Password: Enter the password required to log into the FTP server

NOTE: The "TEST Post Channel 2" button should only be utilized after clicking the 'Save' button otherwise a fail response will be observed. If the test post fails users can view the test post details by clicking on the 'Details' option from the test post screen.

Click 'Save' after changing any settings. Users will be prompted to reboot the AXM-WEB2 immediately or later. If later is chosen the AXM-WEB2 must be rebooted from the 'Management' page in order for the settings to take effect.

The screenshot shows the configuration page for Post Channel 2. The 'Post Channel 2 Enable' section has 'Enable' selected. The 'Post Method' is set to 'FTP'. The 'FTP URL' is 'ftp://test', 'FTP Port' is '21', 'FTP Username' is 'admin', and 'FTP Password' is masked with dots. There are 'Test Post Channel 2' and 'Close Post Channel 2 Logs' buttons at the bottom.

AXM-WEB2 for Acuvim II Series Power Meter

Select the Post Channel 3 tab to configure the settings for post to a second server.

Post Channel 3 Enable: Enable the Post Channel 3 in order to configure the settings needed to post data via the HTTP(S)/FTP post functions

Post Method: Select the method for posting the files, the user can choose HTTP/HTTPS or FTP

Post Name Fixed: This configuration needs to be enabled in order for user to control the name of the file that will be posted. Otherwise file name will be based on the Log File Name Format configuration from the Data Log settings

Post File Name: User can enter a name for the file that will be posted as if Post Name Fixed is enabled

If the HTTP/HTTPS post method is selected:

HTTP/HTTPS URL: Enter the URL for the HTTP/HTTPS server. The URL needs to begin with the prefix http:// or (https://)

HTTP/HTTPS Port: Enter the port number the server will be listening on

HTTP/HTTPS Meter ID: Enter a name or description for the meter to be identified on the server

If the FTP post method is selected:

FTP URL: Enter the URL for the FTP server. The URL needs to begin with the prefix ftp://

FTP Port: Enter the port number the server will be listening on

FTP Username: Enter the username required to log into the FTP server

FTP Password: Enter the password required to log into the FTP server

NOTE: The "TEST Post Channel 3" button should only be utilized after clicking the 'Save' button otherwise a fail response will be observed. If the test post fails users can view the test post details by clicking on the 'Details' option from the test post screen.

Click 'Save' after changing any settings. Users will be prompted to reboot the AXM-WEB2 immediately or later. If later is chosen the AXM-WEB2 must be rebooted from the 'Management' page in order for the settings to take effect.

Chapter 10: Web Interface Readings and Parameter Settings

Meter Communications Management Network Diagnostic Module Firmware Meter Firmware Config Management

Settings Communications Save

Network Network IPv6 Email Time/Date Data Log Post Channel Waveform Post AcuCloud BACnet/IP SNMP DNP IEC61850

EtherNet/IP Remote Access

Post Channel 1 Post Channel 2 Post Channel 3

Post Channel 3 Enable

Disable

Enable

Post Method

HTTP / HTTPS

Post Name Fixed

Enable

Post file name need to be provided.

Post File Name

WEB2

Note: Maximum 20 characters

HTTP / HTTPS URL

http://accuenergy

URL begins with http:// or https://

HTTP / HTTPS Port

800

Range: 0-65535

HTTP / HTTPS Meter ID

Post_Channel_3

Test Post Channel 3 Clear Post Channel 3 Logs

Waveform Post

The AXM-WE2 supports the HTTP and FTP Post functions to send the meters waveform data from the meter to a HTTP/FTP server. The AXM-WE2 can post the Comtrade (.cfg and .dat) files to either an HTTP or FTP servers using the Waveform Post. The settings for the Waveform Post can be found by clicking on the 'Settings' tab and selecting 'Communications', from the Communications page click on the 'Waveform Post' tab.

NOTE: This function is only available on Acuvim IIW models which support the Waveform Capture Function, all other models will not have this feature available.

Waveform Post Enable: Select Enable to enable the waveform post and configure the settings further.

Scan Interval: Users can configure a scan interval where the AXM-WE2 module scans at the Acuvim II meter to check whether there are any power quality events that occurred during the selected scan interval. For example if the scan interval is set for 15 minutes the module will scan for all the power quality events that occurred within 15 minutes and post it to the server.

AXM-WEB2 for Acuvim II Series Power Meter

The scan interval ranges from 15 seconds to 1 month.

File Name Prefix: Users can configure the file name prefix for the Comtrade file that is sent to the server.

Post Method: From the drop down menu select either FTP or HTTP/HTTPS

For FTP configure the following:

FTP URL: Enter the URL for the FTP server. The URL needs to begin with the prefix ftp://

FTP Port: Enter the port number the server will be listening on

FTP Username: Enter the username required to log into the FTP server

FTP Password: Enter the password required to log into the FTP server

For HTTP/HTTPS configure the following:

HTTP/HTTPS URL: Enter the URL for the HTTP/HTTPS server. The URL needs to begin with the prefix http:// or (https://)

HTTP/HTTPS Port: Enter the port number the server will be listening on

HTTP/HTTPS Meter ID: Enter a name or description for the meter to be identified on the server

NOTE: The 'Test Waveform Post' button should only be utilized after clicking the 'Save' button otherwise a fail response will be observed. If the test post fails users can view the test post details by clicking on the 'Details' option from the test post screen.

Similar to the Post Channel function discussed earlier, in the case when there is no connection to the server the AXM-WEB2 will store the posts and send it out after the connection is restored. A maximum of 3000 files will be buffered on module. The 'Clear Waveform Post Channel Logs' button will allow users to clear the buffered waveform files on meter.

There is no interval setting for sending the waveform data using the waveform post, the data will post directly to the FTP/HTTP server when a power quality event has occurred.

NOTE: All waveform capture settings must be configured on the Acuvim software.

Chapter 10: Web Interface Readings and Parameter Settings

Meter Communications Management Network Diagnostic Module Firmware Meter Firmware Config Management

Settings Communications Save

Network Network IPv6 Email Time/Date Data Log Post Channel Waveform Post AcuCloud BACnet/IP SNMP DNP IEC61850

EtherNet/IP Remote Access

Waveform Post Enable

Disable
 Enable

Scan Interval: 1 minute File Name Prefix: Waveform Post

Post Method: FTP

FTP URL: ftp://accuenergy
URL begins with ftp://

FTP Username: .admin
Note: Maximum 40 characters

FTP Port: 123
Range: 0-65535

FTP Password:
Note: Maximum 40 characters

Test Waveform Post Details Waveform Post Log

AcuCloud

The AXM-WEB2 module can directly interface with the Accuenergy Cloud software AcuCloud. The AXM-WEB2 will post data to the cloud software every five minutes.

AcuCloud will require the serial number of the AXM-WEB2 module which will then provide a token that will be used to configure the AXM-WEB2 so it can send its data to AcuCloud.

The settings for the AcuCloud post function can be found by clicking on the 'Settings' tab and selecting 'Communications'. Select '**AcuCloud**' to access the settings to configure the AXM-WEB2 to send data to the cloud.

AcuCloud Enable: Select 'Enable' to enable the function and to further configure the settings related to AcuCloud.

AcuCloud Token: Copy and paste the token provided by the AcuCloud software into this field.

NOTE: The "TEST AcuCloud" button should only be utilized after clicking the 'Save' button otherwise a fail response will be observed. If a fail response occurs after clicking 'Save', please double check the serial number entered in AcuCloud, the token pasted in the web page as well viewing the test post details by clicking on the 'Details' option.

AXM-WEB2 for Acuvim II Series Power Meter

Users can use the 'Link to AcuCloud' to access the cloud software and configure the required settings on that platform. Users must have sufficient access to add devices on their account in order to correctly configure the meter on the software. For inquiries on creating your AcuCloud account please contact Accuenergy Technical Support.

Click 'Save' after changing any settings. Users will be prompted to reboot the AXM-WEB2 immediately or later. If later is chosen the AXM-WEB2 must be rebooted from the 'Management' page for the settings to take effect.

The AXM-WEB2 will post the data continuously every 5 minutes after the reboot.

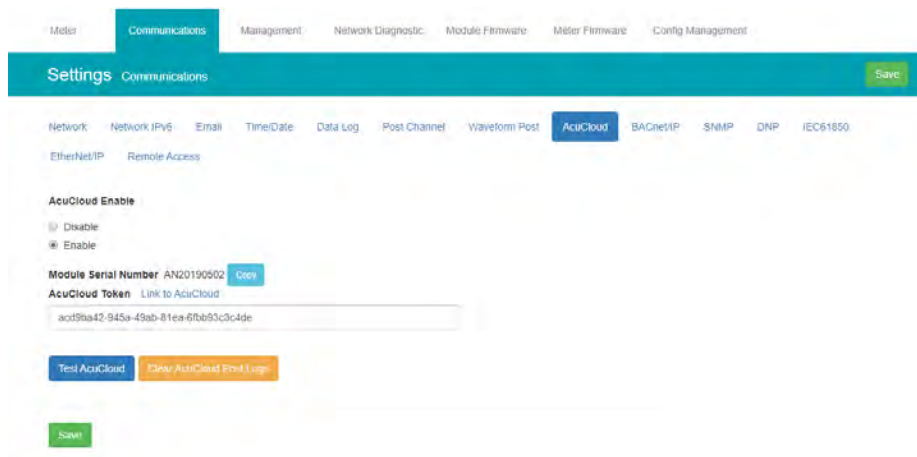

BACnet/IP

The AXM-WEB2 module supports the BACnet/IP protocol. The settings for the BACnet/IP protocol can be found on the web by clicking on the 'Settings' tab and selecting 'Communications'. Once on the communications page select "BACnet/IP" to access the settings to configure the AXM-WEB2 to communicate with a BACnet client.

BacNet Enabled: Select Enable to enable the BACnet protocol.

BACnet Port: Enter the BACnet or UDP port number. Default port is 47808.

Device Instance: Enter the instance number for the device in the BACnet system. It must be unique within the system.

Device Name: Enter a name for the device to distinguish it from other devices within the network.

Chapter 10: Web Interface Readings and Parameter Settings

The screenshot shows a web interface for configuring BACnet settings. The top navigation bar includes 'Meter', 'Communications', 'Management', 'Network Diagnostic', 'Module Firmware', 'Meter Firmware', and 'Config Management'. The 'Settings' page is titled 'Communications' and has a 'Save' button. The 'BACnetIP' tab is selected, showing fields for 'BACnet Enable' (radio buttons for 'Disable' and 'Enable'), 'BACnet Port' (text input with '47808' and a note 'Default: 47505, Range: 47000-49000'), 'Device Instance' (text input with '22222'), 'Device Name' (text input with 'WEB2' and a note 'Note: Maximum 40 characters'), 'Location' (text input with 'Toronto' and a note 'Note: Maximum 40 characters'), and 'Description' (text input with 'Test' and a note 'Note: Maximum 40 characters'). There is also an 'Enable Foreign Device Function' section with radio buttons for 'Disable' and 'Enable', and an 'EPICS file download' button.

Under the "Enable Foreign Device Function", select 'Enable' to communicate with a BACnet device from another subnet.

- Enter the IP of the BACnet Broadcast Management Device(BBMD) under the 'BBMD IP' field for the device which will receive broadcast messages on one subnet and forward them to another subnet.
- Enter BACnet Port of the BBMD in "BBMD Port"
- Enter a value between 5-1440 min in the "Time To Live" for how often the foreign device will register in the BBMD's foreign device table.

Click 'Save' after changing any settings. Users will be prompted to reboot the AXM-WEB2 immediately or later. If later is chosen the AXM-WEB2 must be rebooted from the 'Management' page in order for the settings to take effect.

This screenshot shows the 'Enable Foreign Device Function' section of the BACnet settings page. A red banner above the radio buttons says 'Unsaved changes'. The 'Enable' radio button is selected. Below are fields for 'BBMD IP', 'BBMD Port', and 'Time To Live' (with a note 'Enter time in minutes'). There is also an 'EPICS file download' button and a 'Save' button.

SNMP

The AXM-WEB2 module supports the Simple Network Management Protocol(SNMP) protocol for reporting the metering data to the management station. The AXM-WEB2 uses a public community string for read-only access. By default the module will communicate using SNMP port 161. The AXM-WEB2 also supports 'traps' to send unsolicited messages to up to four management stations.

The settings for the SNMP protocol can be found by clicking on the 'Settings' tab and selecting 'Communications'. From the communications page select the 'SNMP' tab to access the settings to configure the AXM-WEB2 for communication with a SNMP management station.

SNMP Enable: Select 'Enable' to enable the function and to further configure the settings related to the SNMP protocol.

SNMP Port: By default the SNMP Port is configured to 161. The SNMP Port can be any value from ranging from 16100 to 16199.

Read Only Community: By default the community string is Public, this configuration is similar to a password which allows only authorized users to access the meters data.

Trap Enable: Select 'Enable' so that the meter will send a message to the management station when an event is triggered. The event could be a change in Digital Input Status. The notification can then be sent to up to 4 stations.

Trap Target 1: Enter the IP address and port number of station number 1 that should be notified when there is an event.

Trap Target 2: Enter the IP address and port number of station number 2 that should be notified when there is an event.

Trap Target 3: Enter the IP address and port number of station number 3 that should be notified when there is an event.

Trap Target 4: Enter the IP address and port number of station number 4 that should be notified when there is an event.

Report Buffer Size: Enter the size of the buffer for the amount of notifications will be stored before being sent to the management station. A maximum of 30 notifications can be stored.

Report Hold Time: Enter the time in seconds for how long the notification will be in queue before it gets sent to the management station. By default, this setting is configured to 0 so the notification will be sent immediately after an event occurs. This setting could be configured from 0-30 seconds.

Chapter 10: Web Interface Readings and Parameter Settings

Click 'Save' after changing any settings. Users will be prompted to reboot the AXM-WEB2 immediately or later. If later is chosen the AXM-WEB2 must be rebooted from the 'Management' page in order for the settings to take effect.

Meter Communications Management Network Diagnostic Module Firmware Meter Firmware Config Management

Settings Communications Save

Network Network IPv6 Email Time/Date Data Log Post Channel Waveform Post AcuCloud BACnet/IP **SNMP** DNP IEC61850

EtherNet/IP Remote Access

SNMP Enable

Disable

Enable

Read Only Community

public

Note: Minimum 6 characters and maximum 20 characters

SNMP Port

161

Default: 161, Range: 16100-16199

Trap Enable

Disable

Enable

Trap Target 1

192.168.1.195

Trap Target 2

Trap Target 3

Trap Target 4

Report Buffer Size

30

Range: 0-30

Report Hold Time

0

Range: 0-300

MIB file download

DNP

The AXM-WEB2 supports the DNP communications protocol. The Distributed Network Protocol (DNP) is an open protocol used in the electric utility industry for communication and interoperability among substation computers, Remote Terminal Units (RTUs), Intelligent Electronic Devices (e.g. meters), and master stations.

The settings for the DNP protocol can be found by clicking on the 'Settings' tab and selecting 'Communications'. Select 'DNP' to access the settings to configure the AXM-WEB2 to communicate with a DNP master.

AXM-WEB2 for Acuvim II Series Power Meter

Settings Communications Save

Network Network IPv6 Email Time/Date Data Log Post Channel Waveform Post AcuCloud BACnet/IP SNMP **DNP** IEC61850

EtherNet/IP Remote Access

DNP Enable

Disable
 Enable

TCP/IP Mode **Local TCP Port** **Local UDP Port**

Range: 20000-22000 Range: 20000-22000, 0 to disable UDP

Destination IP address **Dual endpoint IP port** **Destination UDP port for initial unsolicited null responses**

Note: Use *.*.*.* to allow all incoming requests Range: 1-65535 Range: 1-65535

Destination UDP port for response **Link address**

Range: 1-65535 Range: 1-65519

Source address validation Disable Enable

Master link address Range: 1-65519

Self address support Disable Enable

Sends confirmed user data frames

Never
 Only for multiframe message fragments
 Always

Time Sync Enable

Disable
 Enable

Time sync period Range: 1-86400 (seconds)

Supports Unsolicited Reporting Disable Enable

DNP Enable: Select 'Enable' to enable the function and to further configure the settings related to the DNP function.

TCP/IP Mode: By default the TCP/IP is set as TCP&UDP, it can be changed to TCP dual endpoint mode or UDP only.

Local TCP Port: Enter the port number for the local TCP server.

Local UDP Port: Enter the port number for the local UDP server.

Destination IP address: The default IP address is set as *.*.*.* to allow all incoming requests.

Chapter 10: Web Interface Readings and Parameter Settings

Dual endpoint IP port: Enter the port number for the endpoint IP server.

Destination UDP port for initial unsolicited null responses: Enter the port number of the destination UDP server for the initial unsolicited null responses.

Destination UDP port for response: Enter the port number of the destination UDP server for response.

Link address: Enter the address number of the slave device.

Master link address: Enter the address number of the master device.

Source address validation: By default the validation is disabled, select 'Enable' to enable the destination address validation.

Supports Unsolicited Reporting: Select 'Enable' to enable the function and further configure the settings related to the unsolicited report.

Number of Unsolicited Retries: Number of retries can be selected as '0', '10' and 'infinite'.

Unsolicited response trigger Condition: Num of class 1 events	<input type="text" value="0"/>	range: 0-255
Unsolicited response trigger Condition: Num of class 2 events	<input type="text" value="0"/>	range: 0-255
Unsolicited response trigger Condition: Num of class 3 events	<input type="text" value="0"/>	range: 0-255
Unsolicited response trigger Condition: Hold time after class 1 events	<input type="text" value="0"/>	range: 0-86400000 (milliseconds)
Unsolicited response trigger Condition: Hold time after class 2 events	<input type="text" value="0"/>	range: 0-86400000 (milliseconds)
Unsolicited response trigger Condition: Hold time after class 3 events	<input type="text" value="0"/>	range: 0-86400000 (milliseconds)

Support for broadcast functionality Disable Enable

AXM-WEB2 for Acuvim II Series Power Meter

Unsolicited response trigger Condition(Num of class # events): Enter the number of events for each class to setup the trigger point. The unsolicited response will be triggered once the number the class events reaches the configured triggering number. The range is from 0-255.

Unsolicited response trigger Condition(Hold time after class # events): Enter the threshold holding time for each class, the unsolicited response will be triggered once the event holding time is longer or equal to the threshold time. The range is from 0-86400000 milliseconds.

Support for broadcast functionality: In DNP there three broadcasting addresses that are supported. Enabling this setting would allow the module to respond to requests (from the client) sending them to the broadcasting addresses.

DNP3 Point Configuration

Users can assign certain parameters to either class 1, class 2 or class 3.

The scale factor is a multiplier that can be applied to a certain parameter when viewing the readings.

An offset can be applied to the reading.

The dead band can be set for each parameter, where if the value of the parameter exceeds the dead band value a DNP event will occur.

DNP3 Point Configuration

Analog-Input: Realtime
Not Selected
 Analog-Input: Realtime
 Analog-Input: Energy
 Analog-Input: Demand
 Analog-Input: THD
 Analog-Input: Volt Harmonics
 Analog-Input: Current Harmonics
 Analog-Input: AI & AO
 Binary-Input: DI Status
 Binary-Input: Virtual Input
 Counter: DI Counter
 Binary-Output: Relay Output
 Binary-Output: Virtual Relay

	Class 1	Class 2	Class 3	Scale Factor	Scale Offset	Deadband
4	<input type="checkbox"/>	<input type="checkbox"/>	<input type="checkbox"/>	1	0	0
5	<input type="checkbox"/>	<input type="checkbox"/>	<input type="checkbox"/>	1	0	0
6	<input type="checkbox"/>	<input type="checkbox"/>	<input type="checkbox"/>	1	0	0
7	<input type="checkbox"/>	<input type="checkbox"/>	<input type="checkbox"/>	1	0	0
8	<input type="checkbox"/>	<input type="checkbox"/>	<input type="checkbox"/>	1	0	0
9	<input type="checkbox"/>	<input type="checkbox"/>	<input type="checkbox"/>	1	0	0
10	<input type="checkbox"/>	<input type="checkbox"/>	<input type="checkbox"/>	1	0	0
11	<input type="checkbox"/>	<input type="checkbox"/>	<input type="checkbox"/>	1	0	0
12	<input type="checkbox"/>	<input type="checkbox"/>	<input type="checkbox"/>	1	0	0
13	<input type="checkbox"/>	<input type="checkbox"/>	<input type="checkbox"/>	1	0	0
14	<input type="checkbox"/>	<input type="checkbox"/>	<input type="checkbox"/>	1	0	0
15	<input type="checkbox"/>	<input type="checkbox"/>	<input type="checkbox"/>	1	0	0
16	<input type="checkbox"/>	<input type="checkbox"/>	<input type="checkbox"/>	1	0	0
17	<input type="checkbox"/>	<input type="checkbox"/>	<input type="checkbox"/>	1	0	0
18	<input type="checkbox"/>	<input type="checkbox"/>	<input type="checkbox"/>	1	0	0

Chapter 10: Web Interface Readings and Parameter Settings

Users can use the 'Batch Modify' button to apply certain settings to all parameters instead of individually configuring each point. Once the configuration in the batch modify is complete click on 'save changes'.

DNP3 Point Configuration

Analog-Input Realtime

Batch Modify

Description	Class 1	Class 2	Class 3	Scale Factor	Scale Offset	Deadband
	<input type="checkbox"/>	<input checked="" type="checkbox"/>	<input type="checkbox"/>	100	10	2

Close Save changes

Batch Modify

Point Number	Description	Class 1	Class 2	Class 3	Scale Factor	Scale Offset	Deadband
0	SystemFrequency	<input type="checkbox"/>	<input checked="" type="checkbox"/>	<input type="checkbox"/>	100	10	2
1	PhaseALine-to-NeutralVoltage	<input type="checkbox"/>	<input checked="" type="checkbox"/>	<input type="checkbox"/>	100	10	2
2	PhaseBLine-to-NeutralVoltage	<input type="checkbox"/>	<input checked="" type="checkbox"/>	<input type="checkbox"/>	100	10	2
3	PhaseCLine-to-NeutralVoltage	<input type="checkbox"/>	<input checked="" type="checkbox"/>	<input type="checkbox"/>	100	10	2
4	AverageLine-to-NeutralVoltage	<input type="checkbox"/>	<input checked="" type="checkbox"/>	<input type="checkbox"/>	100	10	2
5	PhaseA-BLine-to-LineVoltage	<input type="checkbox"/>	<input checked="" type="checkbox"/>	<input type="checkbox"/>	100	10	2
6	PhaseB-CLine-to-LineVoltage	<input type="checkbox"/>	<input checked="" type="checkbox"/>	<input type="checkbox"/>	100	10	2
7	PhaseC-ALine-to-LineVoltage	<input type="checkbox"/>	<input checked="" type="checkbox"/>	<input type="checkbox"/>	100	10	2
8	AverageLine-to-LineVoltage	<input type="checkbox"/>	<input checked="" type="checkbox"/>	<input type="checkbox"/>	100	10	2

After all DNP settings are complete, click on 'Save'. Users will be prompted to reboot the AXM-WEB2 immediately or later. If later is chosen the AXM-WEB2 must be rebooted from the 'Management' page in order for the settings to take effect.

IEC61850

The AXM-WEB2 supports IEC 61850 which is a standard for Ethernet communication among IEDs (intelligent Electronic Devices) in substations.

The settings for IEC 61850 can be found by clicking on the 'Settings' tab and selecting 'Communications'. Select 'IEC61850' to access the settings to configure the AXM-WEB2 to communicate using the standard.

IEC61850 Enable: Select 'Enable' to enable the function and to further configure the settings related to the IEC61850 function.

AXM-WEB2 for Acuvim II Series Power Meter

IEC61850 Port: By default the IEC61850 Port is configured to 102. The IEC61850 Port can be any value from 10200 to 10299.

CID File: The CID file is the configuration file that holds the meter settings pertaining to the IEC 61850 standard. This file can be downloaded from this page and altered by the user in order to meet their requirements.

Select CID File: Users can upload their own CID configuration file by selecting 'Choose File' and then selecting 'Upload' once the correct file is chosen.

Restore to Default: At any point the user can divert back to the original CID file by selecting this button.

Once all settings are entered in correctly click on 'Save' and reboot the communications module. If the user decides to reboot the module later, users will have to perform the reboot manually from the 'Management' page in order for the settings to take effect.

The screenshot shows the 'Settings' page for 'Communications' in the AXM-WEB2 interface. The 'IEC61850' sub-tab is active. The 'IEC61850 Enable' section has radio buttons for 'Disable' and 'Enable', with 'Enable' selected. The 'IEC61850 Port' section has a text input field containing '102', with a default value of 102 and a range of 10200-10299. Below this are buttons for 'CID File Download', 'Select CID file' (with a 'Choose File' button and 'No file chosen' text), 'Upload', and 'Restore Default'. A 'Save' button is at the bottom of the form.

EtherNet/IP

The AXM-WEB2 module supports the Ethernet/IP protocol which is an industrial based network protocol that uses standard Ethernet and TCP/IP technology.

EtherNet/IP Enable: Select Enable to enable the EtherNet/IP protocol

EtherNet/IP Explicit Exchanges Port: Users can configure the EtherNet/IP port, the default port is 44818 and the port number ranges from 44800-44899.

EtherNet/IP Implicit Exchange Interface: Users can select Ethernet 1 or Ethernet 2 for communication.

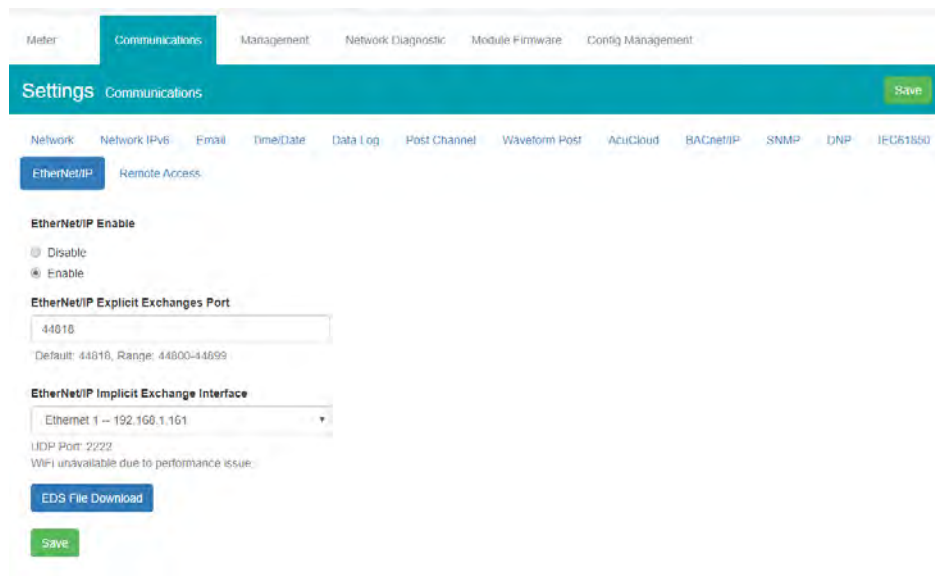

Remote Access

The AXM-WEB2 has a remote access function. This will allow users to provide other users with remote access to the meters web interface. Users will have full functionality and access to all meter readings and settings with this function.

AXM-WEB2 for Acuvim II Series Power Meter

Remote Access Enable: Select 'Enable' to enable the function and allow for Remote Access.

Current Status: Will provide user with a status of the Remote Access on whether it is 'Registered' or 'Unregistered'.

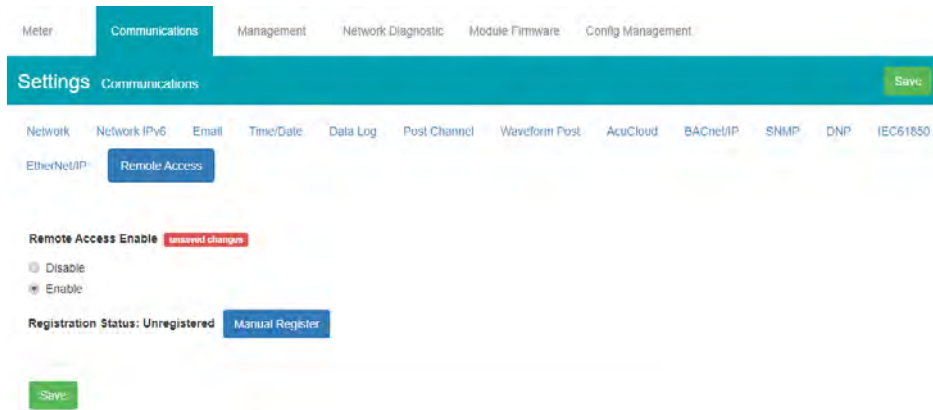

Users can click on the 'Manual Register' button to register the remote access. The following page will be displayed.

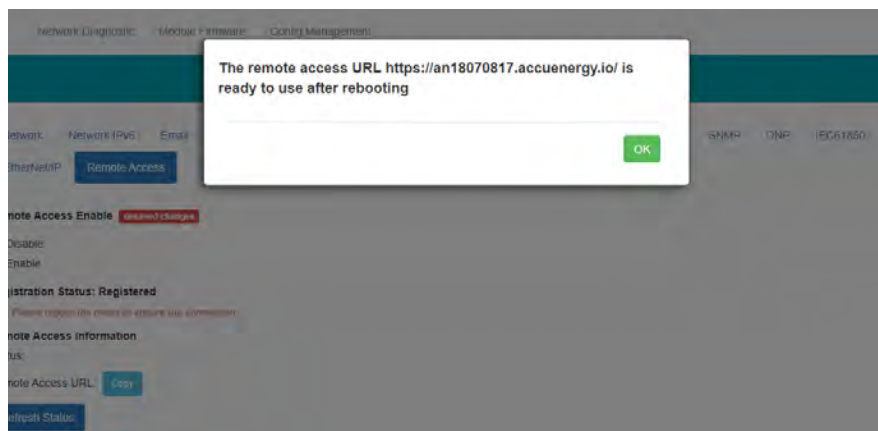

Chapter 10: Web Interface Readings and Parameter Settings

NOTE: The module must be rebooted in order for the remote access connection to work properly.

Registration Status: Displays the status as 'Registered' or 'Unregistered'

Remote Access Information: Lets users know if the remote access status is online or offline.

Remote Access URL: The URL used to access the meters web server remotely. This URL can be copied and shared with all users that require the remote access.

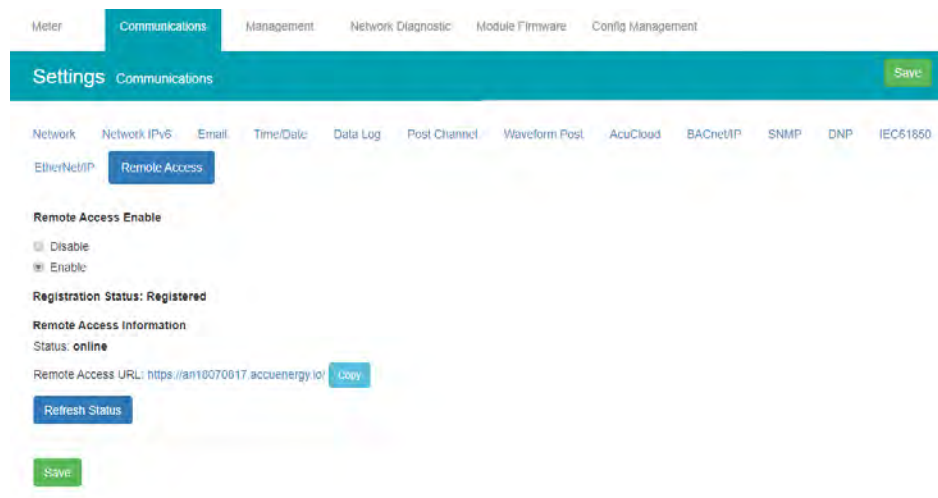

The screenshot shows a web interface for a meter's settings. The top navigation bar includes 'Meter', 'Communications', 'Management', 'Network Diagnostic', 'Module Firmware', and 'Config Management'. The 'Communications' tab is active. Below the navigation bar, there is a 'Settings' section with a 'Save' button. The 'Remote Access' sub-tab is selected. Under 'Remote Access', there are two radio buttons: 'Disable' and 'Enable', with 'Enable' selected. Below this, the 'Registration Status' is 'Registered'. The 'Remote Access Information' section shows the status as 'online' and the 'Remote Access URL' as 'https://an10070017.accuenergy.io', with a 'Copy' button next to it. A 'Refresh Status' button is also present. At the bottom of the settings area, there is another 'Save' button.

10.6.3 Management

Parameter Reset

The Management web page allows the user to clear and reset certain parameters in the meter. The following parameters can be reset from the Management page:

- Demand
- Energy
- Max and Min
- Alarm Record
- Device Run Time

AXM-WEB2 for Acuvim II Series Power Meter

Setting	Action
Reset Demand	<input type="button" value="Reset"/>
Reset Energy	<input type="button" value="Reset"/>
Reset Max and Min	<input type="button" value="Reset"/>
Reset Alarm Record	<input type="button" value="Reset"/>
Reboot Communications Module	<input type="button" value="Reboot"/>
Device Clock	12:43 PM -0400 3 Jun, 2019
Reset Device Run Time	<input type="button" value="Reset"/>

Reboot Meter & Communications Module

Users can also reboot the web module and meter which is required after any communication or meter setting is changed, if a module reboot is not performed the settings will not be saved to the meter and will go back to its default settings. This not only resets the communication module, it also performs a soft reboot on the Acuvim II meter.

Reboot Meter & Communications Module	<input type="button" value="Reboot"/>
--------------------------------------	---------------------------------------

Change Password

The access level passwords can be changed from the Management page as well, all new passwords must be 6 characters or more.

Reset Admin Password	<input type="text" value="Enter old password"/>
	<input type="text" value="Enter new password"/>
	<input type="checkbox"/> Show password
	<input type="button" value="Save"/>
Reset View Password	<input type="text" value="Enter old password"/>
	<input type="text" value="Enter new password"/>
	<input type="checkbox"/> Show password
	<input type="button" value="Save"/>

Reset to Factory

The AXM-WEB2 supports a reset to factory function where if reset the module settings would be configured back to its default factory settings. This impacts all configurations and logs stored on the module.

NOTE: This setting is permanent and cannot be undone!



SSH

The WEB2 module supports the SSH which can be enabled to allow users to remotely log into the meter using the SSH protocol. When enabled the status will show 'On', when disabled the status will show 'Off'.



Debug Diagnostic

The debug diagnostic allows the user to enable or disable the debug logs. The current status will say 'All off' if disabled, 'All On' if enabled.

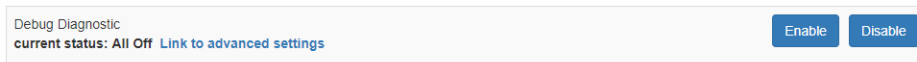

Users can click on the advanced link, to turn on or off specific debug logs. If certain debug logs are enabled the current status will show 'Partial On'.

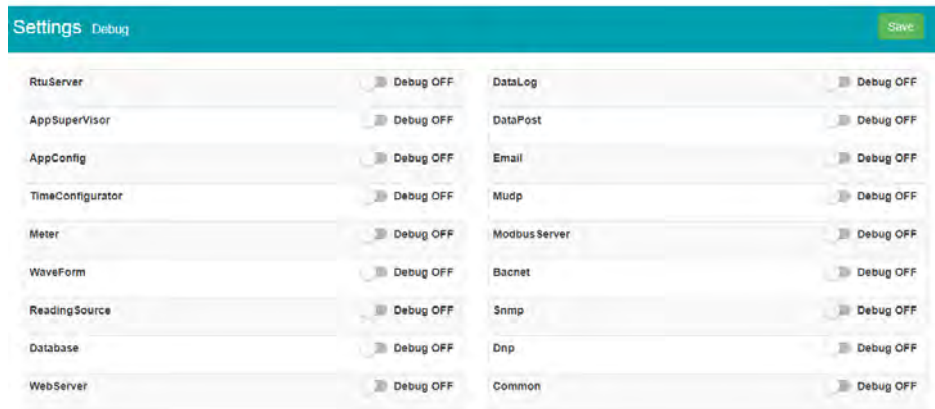

NOTE: The system performance may be affected by enabling the debug logs.

AXM-WEB2 for Acuvim II Series Power Meter

Diagnostic File

There is a diagnostic file on the WEB2 module that users can download which can be used to analyze the modules diagnostics.

NOTE: Please send the diagnostic file to Accuenergy Technical Support

The screenshot displays the 'Settings Management' page in the AXM-WEB2 interface. The page has a teal header with 'Settings Management' and a navigation menu with 'Management' selected. The main content area is a table with columns for 'Setting' and 'Action'. The settings listed are:

Setting	Action
Reset Demand	Reset
Reset Energy	Reset
Reset Max and Min	Reset
Reset Alarm Record	Reset
Reboot Communications Module	Reboot
Device Clock	12:32 PM -0400 3 Jun, 2019
Reset Device Run Time	Reset
Live API Token	85547050-ed25-414f-9f56-55a602b6a109
Reset API Token	Reset
Reset Admin Password	Enter old password Enter new password Show password Save
Reset View Password	Enter old password Enter new password Show password Save
Reset to Factory Defaults	Reset
SSH current status: Off	Enable
Debug Diagnostic current status: All Off Link to advanced settings	Enable Disable

At the bottom of the page, there is a 'Download diagnostic file' button.

10.6.4 Network Diagnostic

The Network Diagnostic page can be used to monitor the network status of the module.

The screenshot displays the 'Network Diagnostic' page with the following sections:

- Ethernet Network:** Shows details for interfaces eth0, eth1, lo, and tun0, including link status, IP address, MAC address, and various error and packet statistics.
- Routing Table:** A table showing kernel IP routing information.

Destination	Gateway	Genmask	Flags	Metric	Ref	Use	State
0.0.0.0	192.168.1.1	0.0.0.0	UH	300	0	0	0 eth0
0.0.0.0	192.168.1.1	0.0.0.0	UG	256	0	0	0 eth1
169.254.0.0	0.0.0.0	255.255.0.0	U	0	0	0	0 tun0
192.168.1.0	0.0.0.0	255.255.255.0	U	0	0	0	0 eth0
192.168.1.0	0.0.0.0	255.255.255.0	U	256	0	0	0 eth1
192.168.0.0	0.0.0.0	255.255.255.0	U	0	0	0	0 viana
- DNS Server:** Lists nameserver addresses such as 8.8.8.8 and 8.8.4.4.
- Network Stat:** A detailed table showing active Internet connections, including protocol, state, local address, foreign address, and state.

AXM-WEB2 for Acuvim II Series Power Meter

In the 'Host Lookup' tab users can utilize the 'ping' function to test the reach-ability to other networks. Users can also use the 'ping6' function to ping an IPv6 address.

The screenshot shows the 'Host Lookup' tab in the 'Network Diagnostic' section. The 'Name of system or domain name to lookup' field contains 'www.google.com'. Below this, there are radio buttons for 'nslookup', 'ping' (which is selected), 'ping6', and 'traceroute'. A 'Lookup' button is visible. The output area shows the results of a ping test to www.google.com, including packet sizes, sequence numbers, and round-trip times.

```
Settings Network Diagnostic
Networking Status Host Lookup Connection Test
Name of system or domain name to lookup
www.google.com
valid ipv4/ipv6 or domain name
nslookup
ping
ping6
traceroute
Lookup
Ping
PING www.google.com (172.217.1.164) 56(84) bytes of data:
64 bytes from yyy180b4-in-f4.1e100.net (172.217.1.164): icmp_seq=1 ttl=54 time=4.00 ms
64 bytes from yyy180b4-in-f4.1e100.net (172.217.1.164): icmp_seq=2 ttl=54 time=4.10 ms
64 bytes from yyy180b4-in-f4.1e100.net (172.217.1.164): icmp_seq=3 ttl=54 time=4.43 ms
64 bytes from yyy180b4-in-f4.1e100.net (172.217.1.164): icmp_seq=4 ttl=54 time=4.54 ms
64 bytes from yyy180b4-in-f4.1e100.net (172.217.1.164): icmp_seq=5 ttl=54 time=4.05 ms
--- www.google.com ping statistics ---
5 packets transmitted, 5 received, 0% packet loss, time 4000ms
rtt min/avg/max/mdev = 4.055/4.250/4.540/0.190 ms
```

User can also use the 'Connection Test' function to test the local network that the module connected to. The test result will show SUCCESS and PASS if there is no issues found.

The screenshot shows the 'Connection Test' tab in the 'Network Diagnostic' section. A 'Begin Test' button is visible. The output area shows the results of a connection test, including ping tests to the loopback address, gateway, and two DNS servers, all of which were successful.

```
Settings Network Diagnostic
Networking Status Host Lookup Connection Test
This diagnostic page will attempt a connection to the specified network nodes.
In the process, all network settings will be tested and a report will be given with detailed results of these tests.
Begin Test
# Loop Back Address #
PING 127.0.0.1 SUCCESS
# Gateway #
PING 192.168.1.1 SUCCESS
# DNS 1 #
PING 8.8.8.8 SUCCESS
# DNS 2 #
PING 8.8.4.4 SUCCESS
TEST COMPLETE 4/4 PASS
```

10.6.5 Module Firmware Update

The Module Firmware web page is used for updating the firmware version on the AXM-WEB2 module. The user can check if the module they are using is up to date and update the module if needed using the remoter firmware update. Users can also manually update the firmware by uploading the firmware file. The current version of the firmware will be displayed on the Module firmware update page and can also be viewed on the 'Device Information' page of the web interface.

There is an Auto Firmware Update feature available also, this allows users to update the module automatically without manually going into the web server and performing the update.

NOTE: Users can also contact Accuenergy Technical Support for latest firmware.

The screenshot shows the 'Module Firmware Upgrade' page in the AXM-WEB2 web interface. At the top, there is a navigation bar with 'Module Firmware' selected. Below the navigation bar, the page title is 'Settings Module Firmware'. The main content area is titled 'Module Firmware Upgrade' and shows 'Current module firmware version: v1.09'. Under 'Auto Firmware Update', there are three radio button options: 'Disable' (unchecked), 'Critical Update Only - Recommended' (checked), and 'Automatically Keep Firmware to Latest Version' (unchecked). Below these options is a 'Check Time' dropdown menu set to '3:00 am - 4:00 am'. There are three buttons: 'Save', 'Check', and 'Upload'. The 'Upload' button is disabled, and the text 'No file chosen' is visible next to the 'Choose File' button.

Auto Firmware Update

The auto firmware update allows users to select three different updating options.

- Disable - Disables the auto firmware update function
- Critical Update Only - Updates the module to the latest critical firmware
- Automatically keep firmware to Latest - Updates the module to the latest firmware

If users select critical or latest firmware update options, the time for the update can be configured. By default the update time is set for 3am-4am.

NOTE: The one hour time block means that the update will occur anytime within the hour.

AXM-WEB2 for Acuvim II Series Power Meter

After the automatic firmware update, when users log in to the web interface for the first time after the update they will see a message displayed, which shows the time and date the module was updated at as well as the firmware version updated to.

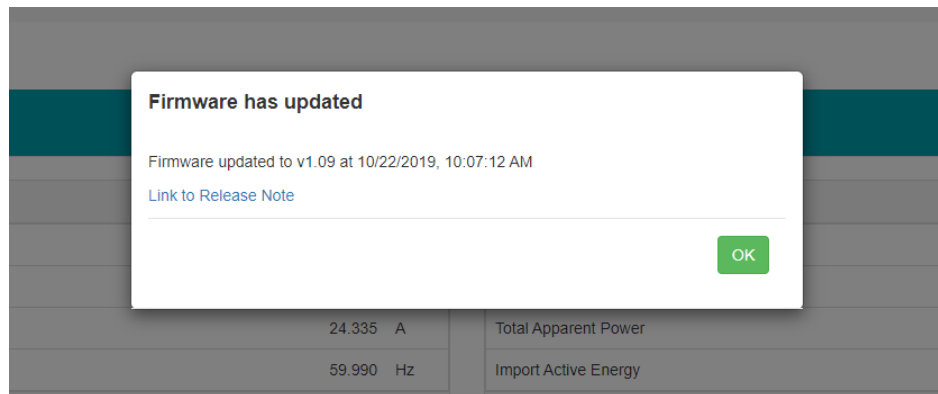

Manual Update

Select and upload the AXM-WEB2 firmware file, it is a .aup file extension.

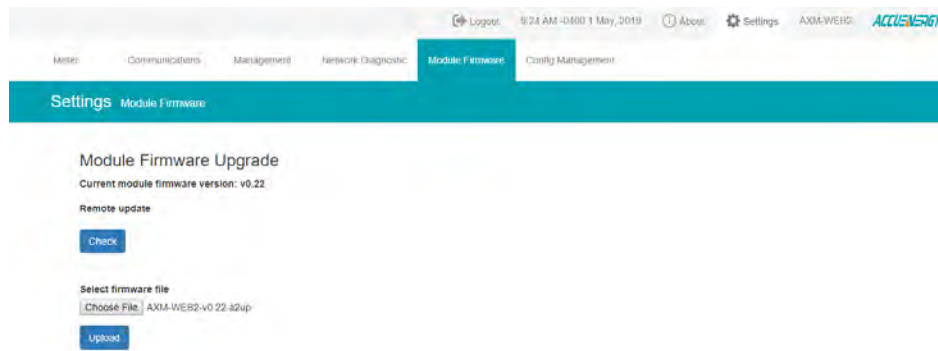

Chapter 10: Web Interface Readings and Parameter Settings

Once the upload was successfully uploaded you will see the following page confirming that the file was uploaded.

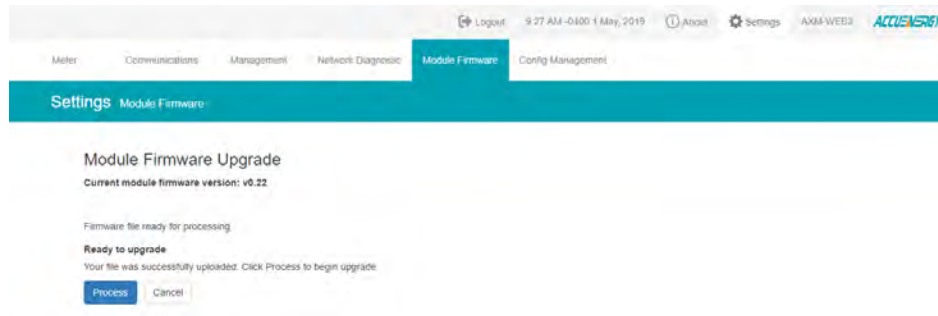

Click 'Process' to begin the update.

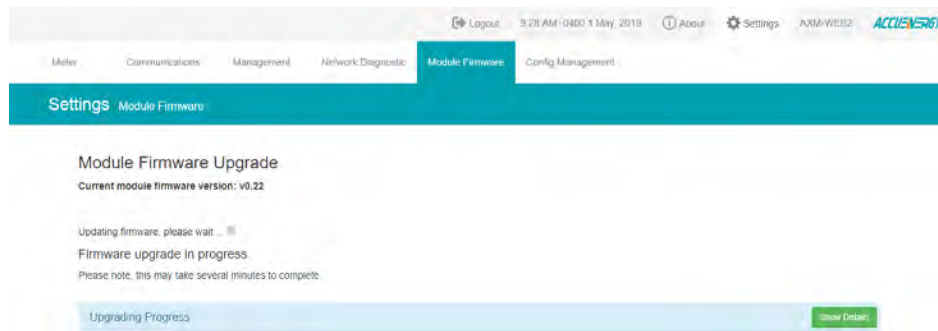

Click 'OK' to log out the web interface and wait for 1-2 minutes to complete the reboot.

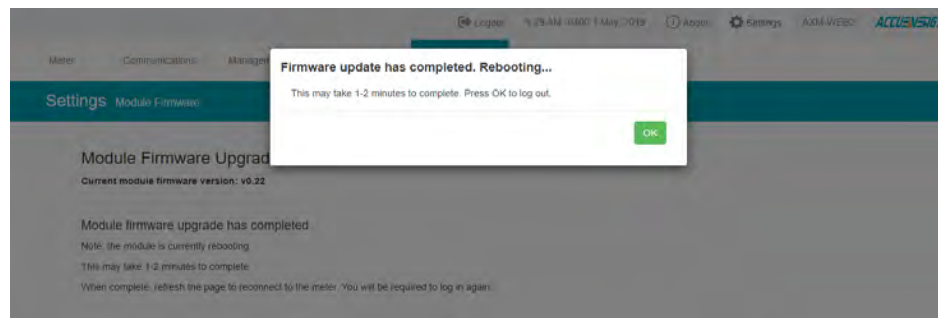

Login to the web interface of AXM-WEB2 after the reboot is complete, and go to the 'About' page to check if the module firmware version is updated.

AXM-WEB2 for Acuvim II Series Power Meter

Remote Update

Users can also use the remote firmware server to update the module firmware. Click on 'Check' to verify if there is a firmware update available.

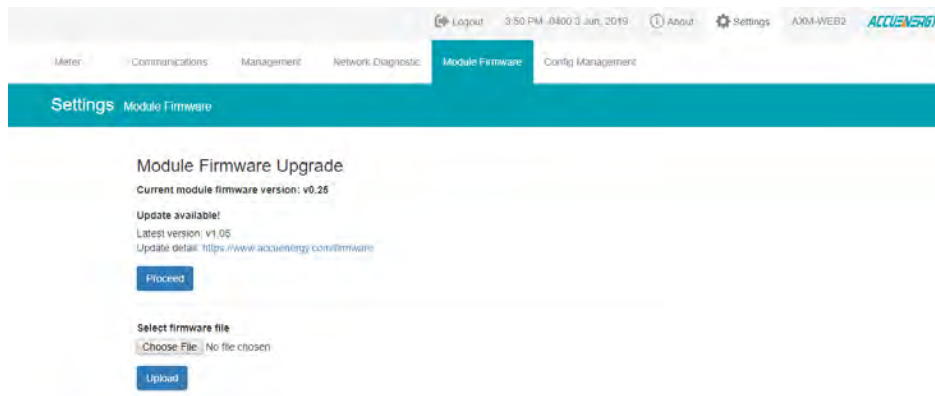

If there is a update available users can proceed to download the firmware.

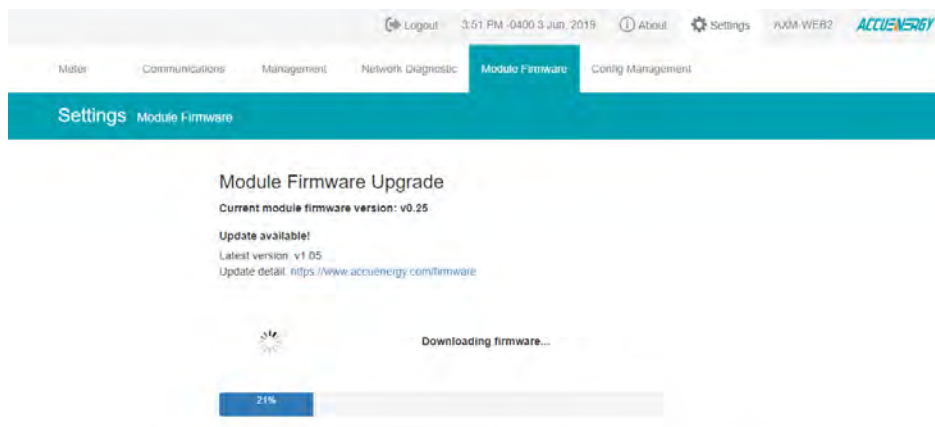

Chapter 10: Web Interface Readings and Parameter Settings

Once the download is complete the updating process will begin.

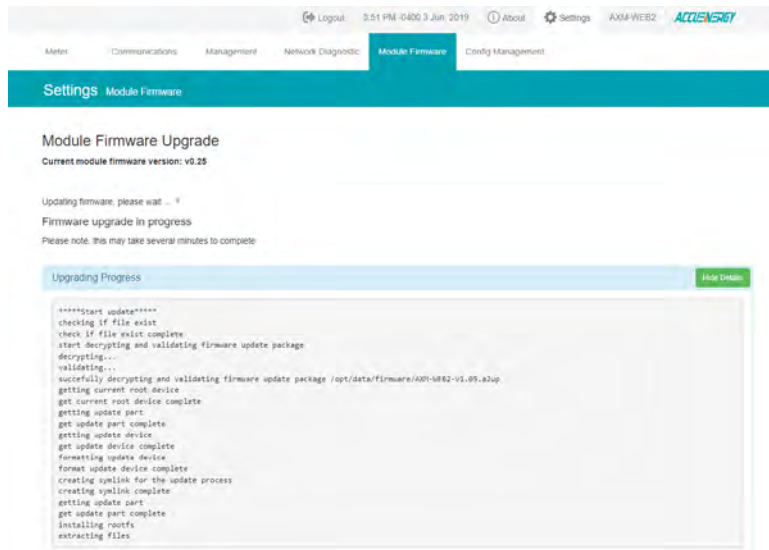

When the firmware update is complete, the module will reboot. The rebooting process will take 1-2 minutes to complete.

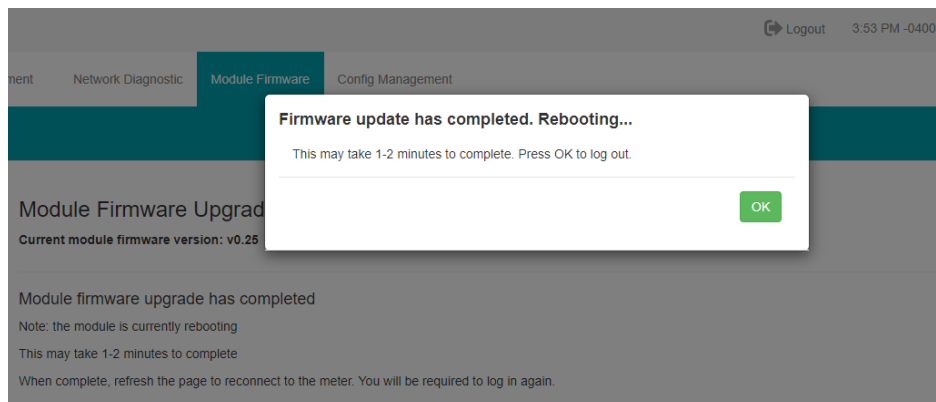

AXM-WEB2 for Acuvim II Series Power Meter

After the module reboots, users will be able to log back into the web interface. When logged in click on the 'About' tab located on the top right corner of the web page to view the 'Device Information' page. From the Device Information page users can ensure that the meter was updated correctly to the right firmware version.

Setting	Value
Meter Model	AcuvimIIW-D-RCT
Meter Serial Number	AH16050101
Meter Firmware Version	v3.69
Device Description	
Module Model	AXM-WEB2
Module Serial Number	AN12345678
Module Hardware Version	v1.00
Module Firmware Version	V1.06
Ethernet 1 MAC Address	EC:C3:8A:12:34:56
Ethernet 2 MAC Address	EC:C3:8A:12:34:57
WiFi MAC Address	00:25:CA:08:36:93
Meter Channel 1 Address	1
Meter Channel 2 Address	1
Seals Status	Open

10.6.6 Meter Firmware Update

The AXM WEB2 allows users to update the meters firmware from its web server. The meters firmware can be updated manually by uploading the required firmware file or by connecting to our remote firmware server.

NOTE: The meter firmware update option is only available on meters that are firmware version 3.69 and above.

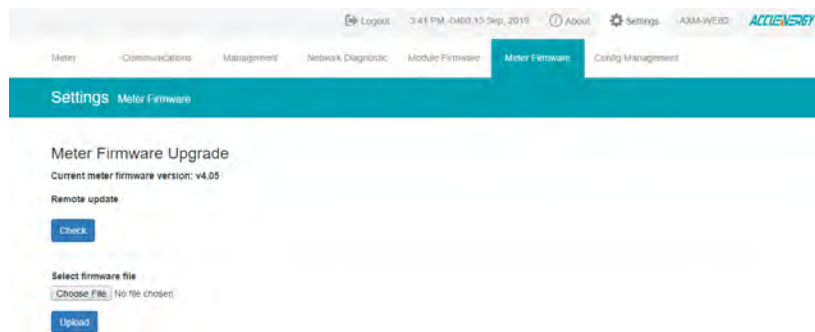

Manual Update

Users can update the meter firmware manually by loading the firmware file to the web server. Click on 'Choose File' and upload the correct file. All firmware files are .abin type files.

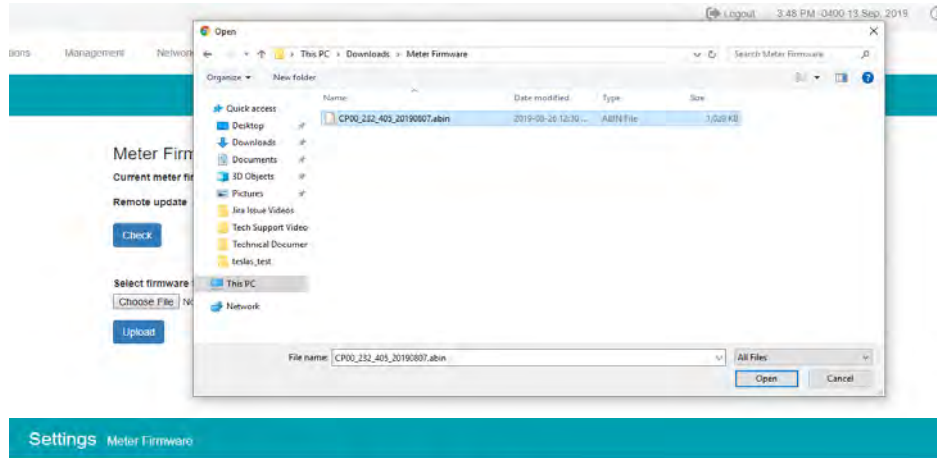

Once the file is selected click on 'Upload'.

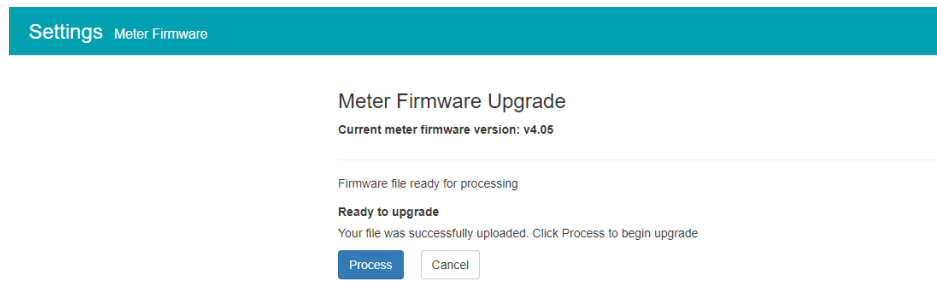

AXM-WEB2 for Acuvim II Series Power Meter

After the firmware has uploaded to the web server, click on 'Process'.

The firmware update will take approximately 5-10 minutes to complete.

Meter Firmware Upgrade

Current meter firmware version: v4.05

Updating firmware, please wait ... ●

Firmware upgrade in progress

Please note, this may take several minutes to complete

Notice: Please do not refresh or leave the page until the upgrade is complete

Notice: Rebooting or disconnecting the meter can cause upgrade failure and activate Emergency Mode, in which repeat the process to recover

Upgrading Progress

Hide Details

```
parseFirmware 0, _mbinLen 0x100000
status 0, numFailure 0
rebootModbusSlave 0
status 1, numFailure 0
configSerial to 9600 bps 0
doCmdRequestToProgram 0
configSerial to 38400 bps 0
doCmdSetupConnection 0
status 2, numFailure 0
write firmware file 16.00%
```

When the firmware update is complete, the module will reboot. The rebooting process will take 1-2 minutes to complete.

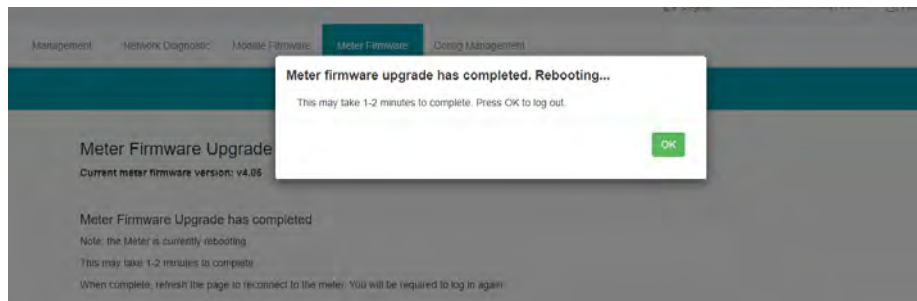

After the meter reboots, users will be able to log back into the web interface. When logged in click on the 'About' tab located on the top right corner of the web page to view the 'Device Information' page. From the Device Information page users can ensure that the meter was updated correctly to the right firmware version.

Chapter 10: Web Interface Readings and Parameter Settings

Device Information

Setting	Value
Meter Model	AcuimilW-D-RCT
Meter Serial Number	AH16050101
Meter Firmware Version	V3.69
Device Description	
Module Model	AXM-WEB2
Module Serial Number	AN12345678
Module Hardware Version	V1.00
Module Firmware Version	V1.06
Ethernet 1 MAC Address	EC:C3:8A:12:34:56
Ethernet 2 MAC Address	EC:C3:8A:12:34:57
WiFi MAC Address	00:25:CA:08:36:93
Meter Channel 1 Address	1
Meter Channel 2 Address	1
Seals Status	Open

Remote Update

Users also have the option to use the remote firmware server to update the meters firmware. Click on 'Check' to verify if there is a firmware update available.

The screenshot shows the 'Meter Firmware Upgrade' section of the web interface. At the top, there is a navigation bar with 'Logout', '9:23 AM - 0400 17 Sep, 2019', 'About', 'Settings', 'AXM-WEB2', and the 'ACUENERGY' logo. Below the navigation bar, there are tabs for 'Meter', 'Communications', 'Management', 'Network Diagnostic', 'Module Firmware', 'Meter Firmware', and 'Config Management'. The 'Meter Firmware' tab is selected. The main content area has a teal header with 'Settings' and 'Meter Firmware'. The 'Meter Firmware Upgrade' section displays the current meter firmware version as v4.05. It indicates that an update is available (v4.07) and provides a link to the update details: <https://www.acuenergy.com>. There is a 'Proceed' button. Below this, there is a 'Select firmware file' section with a 'Choose File' button and the text 'No file chosen'. An 'Upload' button is also present.

If there is a update available users can proceed to download the firmware. Once the download is complete the updating process will begin.

AXM-WEB2 for Acuvim II Series Power Meter

Meter Communications Management Network Diagnostic Module Firmware **Meter Firmware** Config Management

Settings Meter Firmware

Meter Firmware Upgrade

Current meter firmware version: v4.05

Updating firmware, please wait ...

Firmware upgrade in progress

Please note, this may take several minutes to complete

Notice: Please do not refresh or leave the page until the upgrade is complete

Notice: Rebooting or disconnecting the meter can cause upgrade failure and activate Emergency Mode, in which repeat the process to recover

Users can click on 'Show Details' to view the update percentage of the firmware.

Meter Firmware Upgrade

Current meter firmware version: v4.05

Updating firmware, please wait ...

Firmware upgrade in progress

Please note, this may take several minutes to complete

Notice: Please do not refresh or leave the page until the upgrade is complete

Notice: Rebooting or disconnecting the meter can cause upgrade failure and activate Emergency Mode, in which repeat the process to recover

Upgrading Progress

Hide Details

```
parseFirmware 0, _winLen 0x100000
status 0, numFailure 0
rebootToBusSlave 0
status 1, numFailure 0
configSerial to 9600 bps 0
doCmdRequestToProgress 0
configSerial to 38400 bps 0
doCmdSetupConnection 0
status 2, numFailure 0
write firmware file 4.33%
```

When the firmware update is complete, the module will reboot. The rebooting process will take 5-10 minutes to complete.

Chapter 10: Web Interface Readings and Parameter Settings

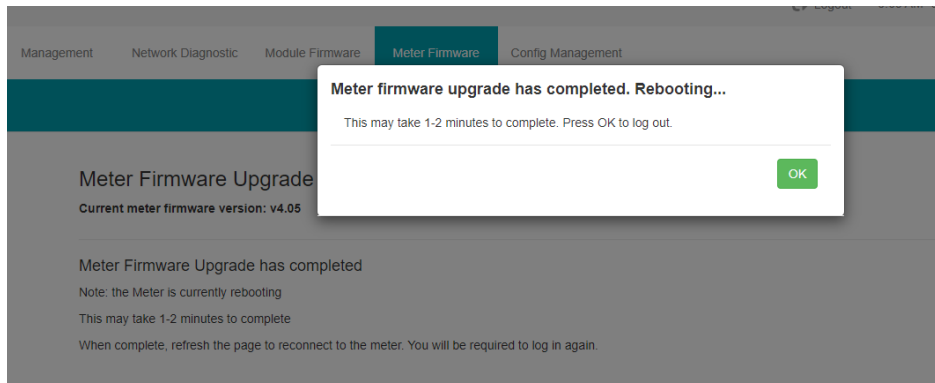

After the meter reboots, users will be able to log back into the web interface. When logged in click on the 'About' tab located on the top right corner of the web page to view the 'Device Information' page. From the Device Information page users can ensure that the meter was updated correctly to the right firmware version.

Device Information

Setting	Value
Meter Model	AcuMiniW-D-RCT
Meter Serial Number	AH16050101
Meter Firmware Version	v3.69
Device Description	
Module Model	AXM-WEB2
Module Serial Number	AH12345678
Module Hardware Version	v1.00
Module Firmware Version	v1.05
Ethernet 1 MAC Address	EC:C3:8A:12:34:56
Ethernet 2 MAC Address	EC:C3:8A:12:34:57
WiFi MAC Address	00:25:CA:08:36:93
Meter Channel 1 Address	1
Meter Channel 2 Address	1
Seals Status	Open

10.6.7 Emergency Mode

During the meter firmware update process if the meter loses power or connectivity to the web interface the meter will run in emergency mode. In this mode the next time the user logs into the web interface instead of seeing the dashboard the following screen will be displayed.

It lets users know that the meter firmware update process has failed and to try updating the meter firmware again. The meter will stay in this mode until the meters firmware has been updated successfully.

Users can update the meters firmware manually or through the remote server while the meter is in Emergency mode. After the update is complete the meter will come out of emergency mode and users will be able to see the web server in its normal mode.

NOTE: The meter will only go into emergency mode if the Meter firmware update fails, emergency mode is not applicable if the Module firmware update fails.

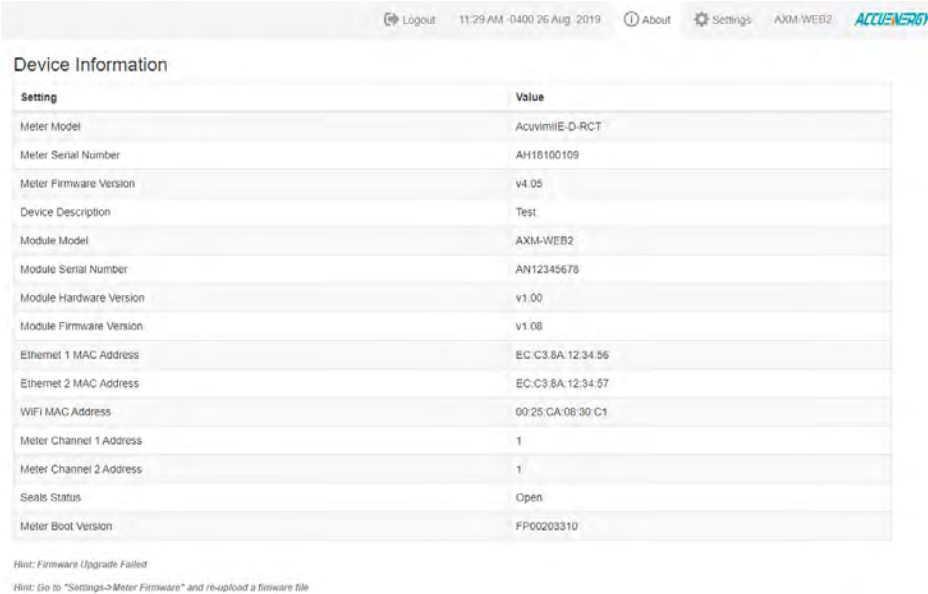

Setting	Value
Meter Model	AcuvimII-E-D-RCT
Meter Serial Number	AH18100109
Meter Firmware Version	v4.05
Device Description	Test
Module Model	AXM-WEB2
Module Serial Number	AN12345678
Module Hardware Version	v1.00
Module Firmware Version	v1.08
Ethernet 1 MAC Address	EC:C3:8A:12:34:56
Ethernet 2 MAC Address	EC:C3:8A:12:34:57
WiFi MAC Address	00:25:CA:08:30:C1
Meter Channel 1 Address	1
Meter Channel 2 Address	1
Seals Status	Open
Meter Boot Version	FP00203310

Hint: Firmware Upgrade Failed
Hint: Go to "Settings->Meter Firmware" and re-upload a firmware file

10.6.8 Config Management

The AXM-WEB2 module has a configuration management page that allows users to save all web settings with the exception of a certain settings into a configuration file. This is useful if users have more than one meter that needs to be programmed with the same settings, and eliminates any error when trying to configure another WEB2 module.

The following settings are saved in the configuration file:

- All Meter settings (General, IO, Alarm, Custom Read, Waveform)
- Network settings (Only DNS1, DNS2, Modbus TCP Port, HTTP Proxy)
- All Email settings
- All Time/Date settings
- All Data Log settings
- All Post Channel settings
- All BACnet settings
- All SNMP settings
- All DNP settings (Point configuration will also be applied)
- All IEC61850 settings (CID file will also be applied)
- Management settings (the View and Admin Access Level passwords, SSH, and Debug Configuration)

The settings that are not included or effected by the Config Management file is:

- Most Network settings (RSTP, DHCP, IP, Submask, Gateway, HTTP Port for both Ethernet 1 and 2. All WiFi settings, Fast Read Mode, HTTP enable, and HTTPS port are not changed)
- IPv6
- AcuCloud
- Remote Access

AXM-WEB2 for Acuvim II Series Power Meter

The Config Management page can be accessed by clicking on the 'Settings' tab and selecting 'Config Management'.

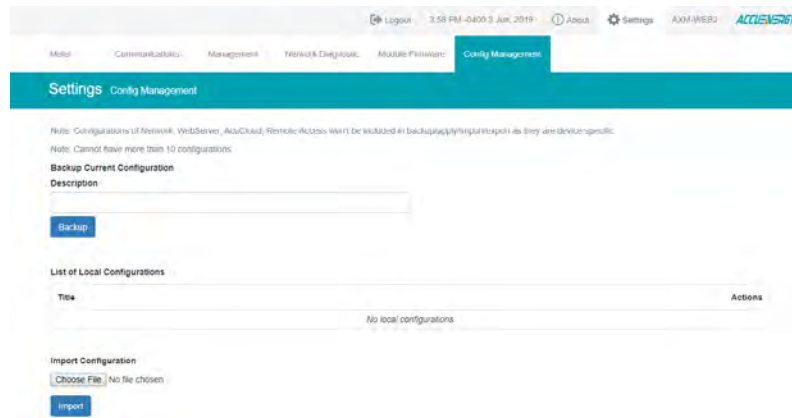

Users can create a backup of the current configurations on the WEB2 interface.

Backup Current Configuration Description: Enter in a description for the backup configuration file.

Once the description is entered in click on the 'Backup' button.

The backup is displayed in the List of Local Configurations. The file has a file format that includes the module serial number, module firmware version, and time stamp that the file was created.

NOTE: Users cannot have more than 10 configurations in the List of Local Configurations.

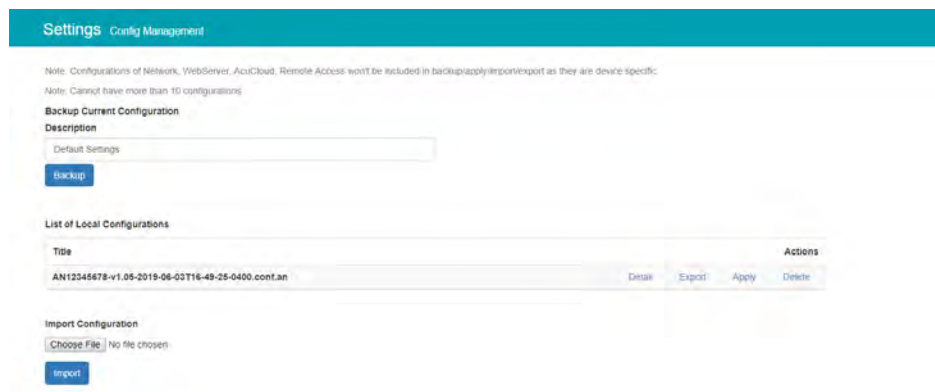

Chapter 10: Web Interface Readings and Parameter Settings

Users can click on 'Detail' to view the description of the configuration file. The details include the Model name, serial number, time created, firmware version and the description entered when the backup was created.

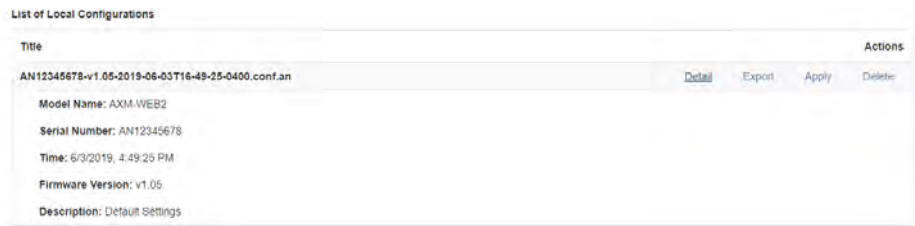

Title	Actions
AN12345678-v1.05-2019-06-03T16-49-25-0400.conf.an	Detail Export Apply Delete
Model Name: AXM-WEB2	
Serial Number: AN12345678	
Time: 6/3/2019, 4:49:25 PM	
Firmware Version: v1.05	
Description: Default Settings	

Users can export the configuration file and use it on other WEB2 modules. The file is downloaded as a .an file.

To implement the configuration file click on 'Apply'. A prompt warning the user that the existing .conf.an file will be overwritten is shown. Click 'Yes' to continue.

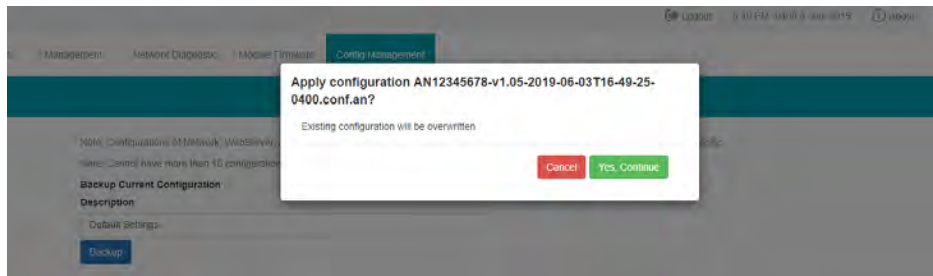

A module reboot is required for the configuration to take effect. If users decided to reboot later the reboot must be performed from the Management page in order for the settings to take effect on the device.

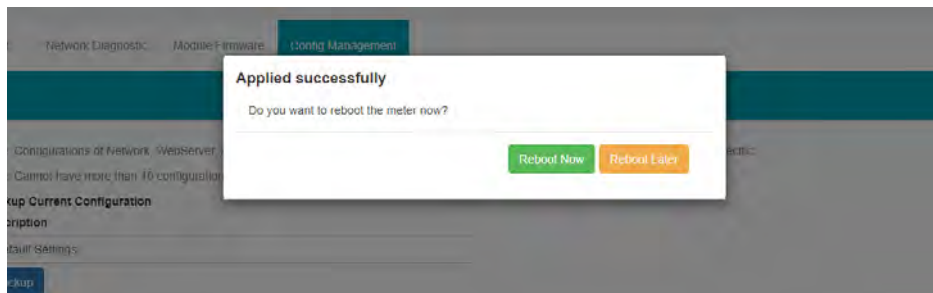

AXM-WEB2 for Acuvim II Series Power Meter

Users can remove any of the configuration files from the list at any time by selecting 'Delete'.

Import Configuration: Users can import a configuration file (.conf.an file format) to the WEB2 module.

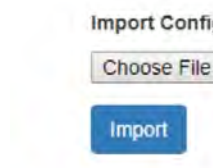

Click on 'Import' to upload the configuration file to the WEB2 module.

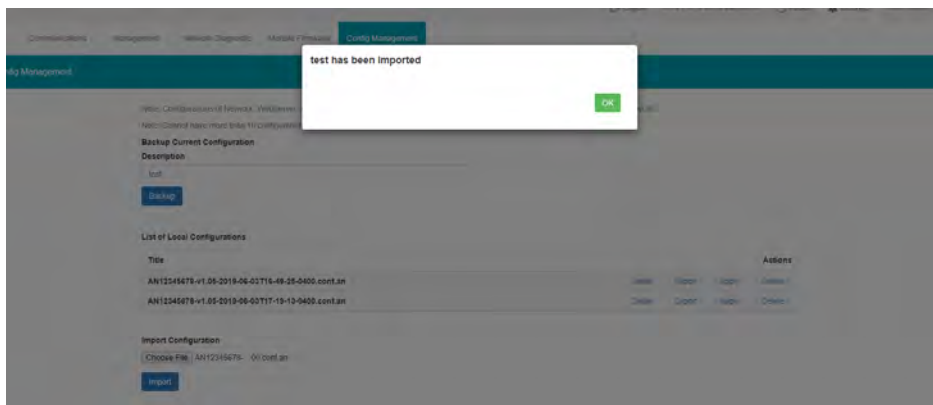

The newly imported file will now appear in the List of Local Configurations.

List of Local Configurations	
Title	Actions
AN12345678-v1.05-2019-06-03T16-49-25-0400.conf.an	Detail Export Apply Delete
AN12345678-v1.05-2019-06-03T17-19-13-0400.conf.an	Detail Export Apply Delete

NOTE: Users cannot import a file that already exists on the local configurations, when the list already contains 10 config files, and cannot import a config file that has been exported from a WEB2 module with a higher firmware version.

