

FLUKE® 715 Volt/mA Calibrator

Instruction Sheet

Introduction

The Fluke 715 Volt/mA Calibrator is a source and measurement tool for 0 to 24 mA current loop testing and dc voltage from 0 to 20/25 V. The calibrator does not source and measure simultaneously.

Your calibrator is supplied with a holster, a set of test leads, an installed 9 V alkaline battery, and this instruction sheet.







Summary of Calibrator Capabilities

Function	Range	Resolution
dc mV input	0 to 200 mV	0.01 mV
dc mV output		
dc V input	0 to 25 V	0.001 V
dc V output	0 to 20 V	
dc mA input	0 to 24 mA	0.001 mA
dc mA output		
Loop power output	24 V dc output	N/A

PN 650314 July 1997 Rev. 3, 8/05
©1997-2005 Fluke Corporation. All rights reserved. Printed in U.S.A.
All product names are trademarks of their respective companies.

715 English Instruction Sheet
Page 2

International Symbols

Symbol	Meaning
	Earth ground
	Fuse
	Battery
	Refer to this instruction sheet for information about this feature.
	Double insulated
	Conforms to relevant Canadian Standards Association directives.
	Conforms to European Union directives

Safety Information

Use the calibrator only as specified in this sheet, otherwise the protection provided by the calibrator may be impaired.

A **Warning** identifies conditions and actions that pose hazard(s) to the user; a **Caution** identifies conditions and actions that may damage the calibrator or the equipment under test.

⚠ Warning

To avoid possible electric shock or personal injury:

- **Never apply more than 30 V between any two jacks (terminals), or between any jack and earth ground.**
- **Make sure the battery door is closed and latched before you operate the calibrator.**
- **Remove test leads from the calibrator before you open the battery door.**
- **Do not operate calibrator if it is damaged.**
- **Do not operate the calibrator around explosive gas, vapor, or dust.**
- **When servicing the calibrator, use only specified replacement parts.**

Caution

Use the proper jacks, function, and range for your measurement or output application.

Turning the Calibrator On





Press the green © pushbutton to turn the calibrator on and off.

For longest battery life:



- For mA output, use current simulate mode instead of source mode when an external 24 to 30 V loop power supply is available. (See Simulating a Transmitter.)
- Turn off the calibrator when not in use.

Auto Shut-Off (Power Saver) Feature

The Calibrator automatically turns off after 30 minutes of inactivity. To reduce this time or disable this feature:



1. With the Calibrator OFF, press the  key. **P.S.xx** is displayed, where **xx** is the turn-off time in minutes. **OFF** means the power saver is disabled.
2. Press  and/or  to increase or decrease the turn-off time in minutes.
3. To disable, press  until the display shows **OFF**.









HART™ Resistor Mode

The calibrator has a user selectable 250 ohm HART™ resistor to facilitate use with HART™ communication devices. The resistor can be switched in/out at any time by simultaneously pressing the  and  keys. Use a HART™ communicator when measuring dc mA with loop power or sourcing mA.

Span Check Feature

The calibrator allows the users to store 0% and 100% setpoints for each output function. Once setpoints are stored, the span check feature allows the user to quickly toggle back and forth from 0% to 100% or to step in 25% increments.

Automatic step and ramp modes can be enabled while in the span check mode by simultaneously pressing the   keys. First select the desired output mode (V,mV or mA) then proceed to store the setpoints:

1. Storing 0% and 100% Setpoints
2. Using the   controls set the output to the desired output value for 0%.
3. Press the   scroll keys simultaneously to store the 0% value.
4. Now using the   controls set the output to the desired output value for 100%
5. Again, press the   scroll keys simultaneously to store the 100% value.

Measuring dc Volts

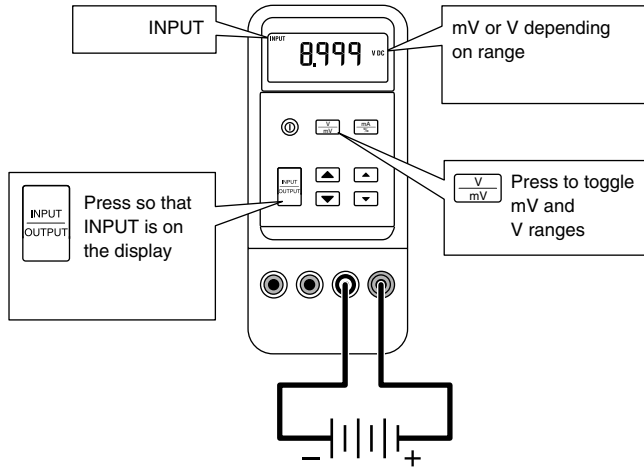

it01i.eps

Sourcing dc Volts

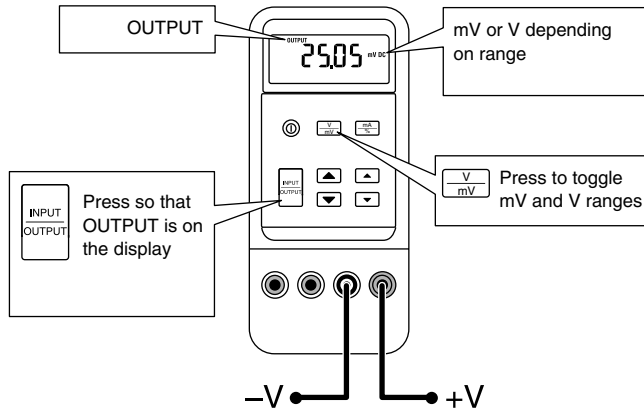

it02i.eps

Measuring dc mA

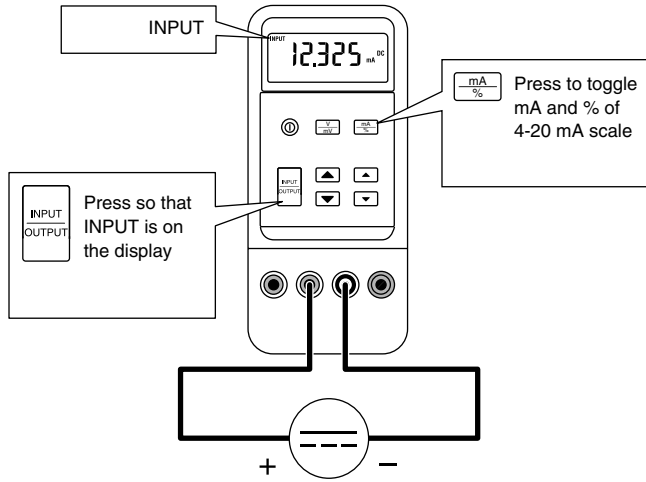

it03i.eps

Measuring dc mA with Loop Power

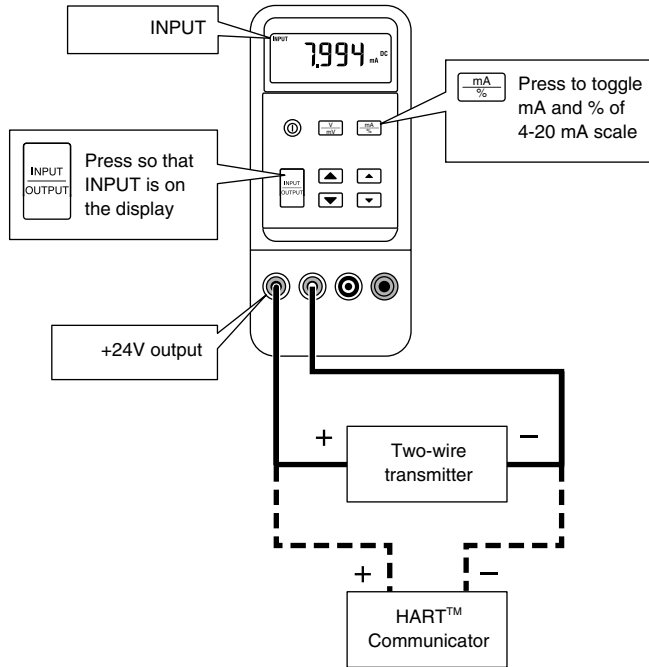

it06i.eps

Using the Current Output Modes

The calibrator provides current output in mA or percent display. Percent is -25.00 to 125.00%, where 0% is 4 mA, and 100% is 20 mA.

In source mode, the calibrator supplies the current. In simulate mode, the calibrator simulates a two-wire transmitter in an externally-powered current loop.

Sourcing mA

Use source mode whenever you need to supply current into a passive circuit such as a current loop with no loop supply. Insert the test leads into the OUTPUT + and - mA jacks as shown below.

Note

A path must exist for current to flow between the OUTPUT + and -mA jacks, otherwise the display will indicate an overload (OL) when you set an output value.

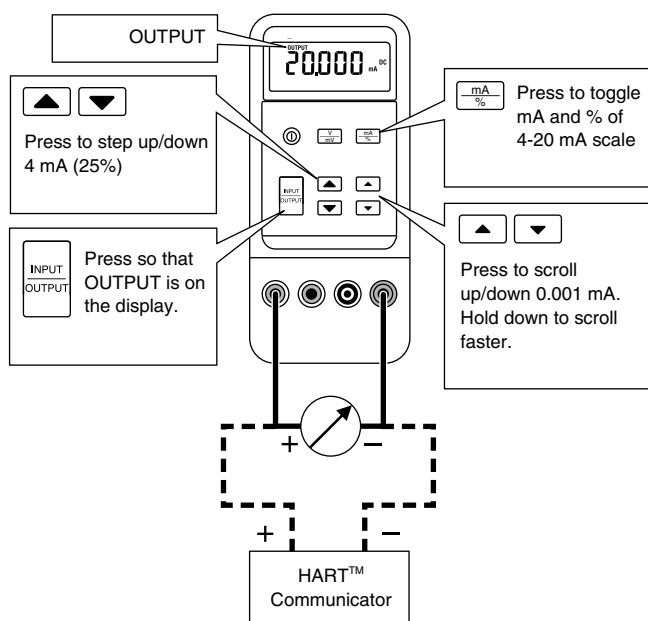

it04i.eps

715 English Instruction Sheet

Page 9

Simulating a Transmitter

Use simulate mode when an external 24 to 30 V loop power supply is available.

Insert the test leads into the mA SIMULATE – and + jacks as shown below.

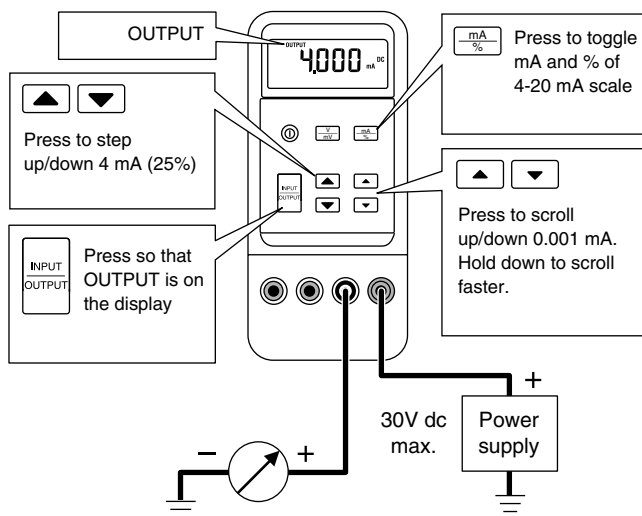

it05i.eps

Maintenance

For maintenance procedures not described in this sheet, contact a Fluke Service Center.

In Case of Difficulty

- Check the battery and test leads. Replace as necessary.
- Review this sheet to make sure you are using the correct jacks and pushbuttons.

If the calibrator needs repair, contact a Fluke Service Center. If the calibrator is under warranty, see the warranty statement below for terms. If the warranty has lapsed, the calibrator will be repaired and returned for a fixed fee. Contact a Fluke Service Center for information and price.

Cleaning

Periodically wipe the case with a damp cloth and detergent; do not use abrasives or solvents.

Calibration

Calibrate your calibrator once a year to ensure that it performs according to its specifications. A calibration manual is available (PN 686540). Call 1-800-526-4731 from the USA and Canada. In other countries, contact a Fluke Service Center.

Replacing the Battery

⚠ Warning

To avoid false readings, which could lead to possible electric shock or personal injury, replace the battery as soon as the battery indicator (🔋) appears.

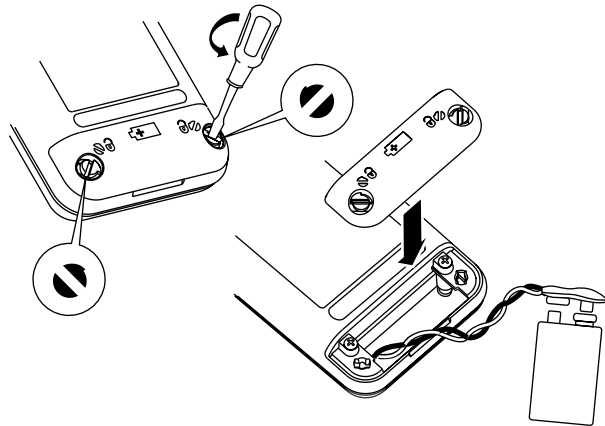

it07i.eps

Replacement Parts and Accessories

Replacement Parts

Item	Description	PN or Model no.	Qty.
BT1	9V battery, ANSI/NEDA 1604A or IEC 6LR61	614487	1
H80M	Holster, Yellow, hanging	H80M	1
MP85	Case top	620200	1
MP86	Case bottom	2397526	1
H2, 3, 4	Case screw	832246	3
MP89, 90	Non-skid foot	824466	2
MP8	O-ring for input/output receptacle	831933	1
MP92	Battery door	619947	1
H5, 6	Battery door fasteners	948609	2
S1	Keypad	687100	1
TL75	Test lead set	TL75	1
-	Instruction sheet	650314	1
AC72	Alligator clips	AC72	1
TL20	Industrial test lead set	TL20	Option
-	71X Calibration Manual	686540	Option

715 English Instruction Sheet
Page 13

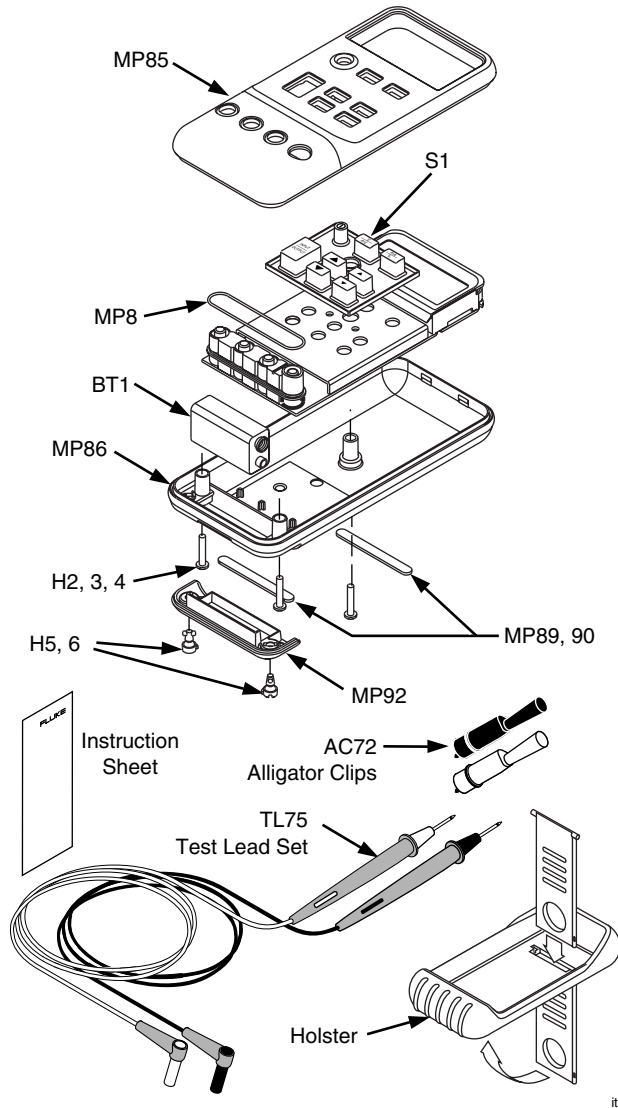

it10c.eps

Specifications

Specifications are based on a one year calibration cycle and apply from +18°C to +28°C unless stated otherwise. "Counts" means number of increments or decrements of the least significant digit.

DC V Input and Output

Range	Resolution	Accuracy, ±(% of Reading + Counts)
200 mV	0.01 mV	0.015% + 2
20 V output	0.001 V	0.01% + 2
25 V input		
<i>Input impedance: 1 MΩ (nominal), < 100 pF</i> <i>Overvoltage protection: Fuseless</i> <i>Voltage drive capability: 1 mA</i>		

DC mA Input

Range	Resolution	Accuracy, ±(% of Reading + Counts)
24 mA	0.001 mA	0.01% + 2
<i>Overload protection: Fuseless</i>		

DC mA Output

Range: 0 mA to 24 mA

Percent display: 0% = 4 mA, 100% = 20 mA

Accuracy: ±(0.01% of reading + 2 counts)

Source mode:

Compliance: 1000 Ω at 20 mA for battery voltage ≥6.8 V (700 Ω at 20 mA for battery voltage 5.8 to 6.8 V)

Simulate mode:

External loop voltage requirement: 24 V nominal, 30 V maximum, 12 V minimum

Loop Power

24 V ±10%

General Specifications

Maximum voltage applied between any jack and earth ground or between any two jacks: 30 V

Storage temperature: -40°C to 60°C

Operating temperature: -10°C to 55°C

Operating altitude: 3000 meters maximum

Temperature coefficient: $\pm 0.005\%$ of range per °C for the temperature ranges -10 to 18°C and 28 to 55°C

Relative humidity: 95% up to 30°C, 75% up to 40°C, 45% up to 50°C, and 35% up to 55°C

Vibration: Random 2 g, 5 to 500 Hz

Shock: 1 meter drop test

Safety: Certified as compliant to CAN/CSA C22.2 No. 1010.1:1992. Complies with ANSI/ISA S82.01-1994.

Power requirements: Single 9 V battery (ANSI/NEDA 1604A or IEC 6LR61)

Size: 32 mm H x 87 mm W x 187 mm L (1.25 in H x 3.41 in W x 7.35 in L);

With holster: 52 mm H x 98 mm W x 201 mm L (2.06 in H x 3.86 in W x 7.93 in L)

Weight: 349 g (12.3 oz);

With holster: 601 g (21.2 oz)

LIMITED WARRANTY & LIMITATION OF LIABILITY

This Fluke product will be free from defects in material and workmanship for three years from the date of purchase. This warranty does not cover fuses, disposable batteries or damage from accident, neglect, misuse or abnormal conditions of operation or handling. Resellers are not authorized to extend any other warranty on Fluke's behalf. To obtain service during the warranty period, send your defective calibrator to the nearest Fluke Authorized Service Center with a description of the problem.

THIS WARRANTY IS YOUR ONLY REMEDY. NO OTHER WARRANTIES, SUCH AS FITNESS FOR A PARTICULAR PURPOSE, ARE EXPRESSED OR IMPLIED. FLUKE IS NOT LIABLE FOR ANY SPECIAL, INDIRECT, INCIDENTAL OR CONSEQUENTIAL DAMAGES OR LOSSES, ARISING FROM ANY CAUSE OR THEORY. Since some states or countries do not allow the exclusion or limitation of an implied warranty or of incidental or consequential damages, this limitation of liability may not apply to you.