



PPC4E Pressure Controller/Calibrator

Operation and Maintenance Manual

Warning

- **High pressure liquids and gases are potentially hazardous. Energy stored in these liquids and gases can be released unexpectedly and with extreme force. High pressure systems should be assembled and operated only by personnel who have been instructed in proper safety practices.**
- **The PPC4E must be properly earthed. Only use a supply outlet that has a protective earth contact. If there is any doubt as to the effectiveness of the supply outlet earth, do not connect the PPC4E.**
- **This instrument is not to be operated in any other manner than that specified by the manufacturer.**

© 2010 **Fluke Calibration** All rights reserved.

Information in this document is subject to change without notice. No part of this document may be reproduced or transmitted in any form or by any means, electronic or mechanical, for any purpose, without the express written permission of **Fluke Calibration, 4765 East Beautiful Lane, Phoenix, Arizona 85044-5318 USA.**

Fluke Calibration makes sincere efforts to ensure the accuracy and quality of its published materials; however, no warranty, expressed or implied, is provided. **Fluke Calibration** disclaims any responsibility or liability for any direct or indirect damages resulting from the use of the information in this manual or products described in it. Mention of any product or brand does not constitute an endorsement by **Fluke Calibration** of that product or brand. This manual was originally composed in English and was subsequently translated into other languages. The fidelity of the translation cannot be guaranteed. In case of conflict between the English version and other language versions, the English version predominates.

Products described in this manual are manufactured under international patents and one or more of the following U.S. patents: 5,142,483; 5,257,640; 5,331,838; 5,445,035. Other U.S. and international patents pending.

AutoRange, AutoZ, **Fluke Calibration**, **FCAL**, **DH**, **DHI**, COMPASS, PPC, PPC4E, RPT, RPM, RPM4, SDS and SPLT are trademarks, registered and otherwise, of **Fluke Corporation**.

Document No. 3890723
100901
Printed in the USA

Table Of Contents

Table Of Contents.....	III
Tables	VII
Figures	VIII
About This Manual	IX
1. Introduction	1
1.1 Product Overview.....	1
1.2 Specifications.....	1
1.2.1 General Specifications.....	1
1.2.2 Pressure Measurement Specifications	2
1.2.2.1 PPC4E Models and Ranges.....	2
1.2.2.2 On-Board Barometer.....	3
1.2.3 Pressure Control Specifications	4
2. Installation.....	5
2.1 Unpacking and Inspection.....	5
2.1.1 Removing from Packaging.....	5
2.1.2 Inspecting Contents.....	5
2.2 Site Requirements.....	6
2.3 Setup	6
2.3.1 Preparing for Operation.....	6
2.3.2 Front and Rear Panels	7
2.3.2.1 Front Panel.....	7
2.3.2.2 Rear Panel.....	7
2.3.3 Power Connection.....	8
2.3.4 Connecting to a Pressure Supply (Supply Port)	8
2.3.5 Connecting a Vacuum Pump (Exhaust Port).....	8
2.3.6 Connecting to the Device Under Test (Test(+) and Test(-) Ports)	8
2.3.6.1 Installing a Self Purging Liquid Trap (SPLT).....	10
2.3.6.2 Installing a Dual Volume Unit (DVU), PPC4E 15 K and PPC4EX 100K	10
2.3.7 The ATM Port.....	10
2.3.8 Check/Set Security Level.....	10
2.3.9 Turn Off Absolute and Negative Gauge Mode.....	10
2.4 Power-Up And Verification	11
2.4.1 Switch Power On.....	11
2.4.2 Check Pressure Measurement Operation.....	11
2.4.2.1 Checking Absolute Mode Pressure Measurement	11
2.4.2.2 Checking Gauge Mode Pressure Measurement	11
2.4.3 Leak Test	11
2.4.4 Purge.....	12
2.4.5 Check Pressure Control Operation.....	12
2.5 Short Term Storage.....	12
3. Operating Principles	13
3.1 User Interface	13
3.2 General Operating Principles.....	13
3.2.1 Direct Pressure Control	13
3.2.2 Automated Pressure Control.....	13
3.2.2.1 Dynamic Control.....	14
3.2.2.2 Static Control	14
3.2.3 Pressure Ready/Not Ready.....	15
3.2.4 Gauge and Negative Gauge Modes with an Absolute Reference Pressure Transducer, Dynamic Compensation for Atmospheric Pressure	16

TABLE OF CONTENTS

3.2.5	Multiple RPTs	17
3.2.6	Multiple Ranges (RPTs, AutoRange and Infinite Ranging).....	18
3.2.7	AutoRange.....	18
3.2.8	Range.....	20
3.2.9	Unit.....	20
3.2.10	Measurement Mode.....	21
3.2.11	Set Pressure Automatically	21
3.2.12	Control	22
3.2.13	Vent.....	23
3.2.14	AutoTest	23
3.2.15	Head	24
3.2.16	Purge.....	25
3.2.17	Leak Test	26
3.2.18	Resolution	26
3.2.19	Jog	27
3.2.20	Pressure Limits	27
3.2.20.1	Over Pressure Function	28
3.2.21	Drivers	28
3.2.22	Remote.....	29
3.2.23	Reset.....	29
3.2.23.1	Settings	29
3.2.23.2	Units.....	30
3.2.23.3	AutoTest	30
3.2.23.4	Calibration.....	30
3.2.23.5	All.....	31
3.2.24	Preferences	32
3.2.24.1	Screen Saver	32
3.2.24.2	Sounds.....	32
3.2.24.3	Time.....	32
3.2.24.4	Language.....	33
3.2.24.5	Security.....	33
3.2.25	Internal Functions	34
3.2.25.1	Identification.....	34
3.2.25.2	Control Reference.....	35
3.2.25.3	Barometer	35
3.2.25.4	Purge	36
3.2.25.5	Log.....	36
3.2.25.6	TEST (-) Vent.....	36
3.2.26	Calibration	37
3.2.27	Measurement Uncertainty.....	37
3.2.27.1	Product Uncertainty.....	37
3.2.27.2	Span	38
3.2.27.3	Head	38
3.2.27.4	Zero Stability (Constant).....	38
3.2.27.5	Control Uncertainty	38
3.2.27.6	Combining uncertainties	39
3.2.27.7	Delivered Pressure Uncertainty	39
3.2.27.8	Using Values Other Than Default	40
4.	Operation	41
4.1	Main Run Screen	41
4.2	Other Screens.....	42
4.3	Keypad Layout and Protocol.....	44
4.4	Conventions for the Graphical Interface	44
4.4.1	Navigation Controls and Keypad	44
4.4.2	Navigating Menus	44
4.5	Pressure Control	47
4.5.1	Set Pressure Automatically	47
4.5.1.1	Interrupting Automated Pressure Control.....	47
4.5.1.2	Automated Pressure Commands for Zero Pressure	47
4.5.2	Manual Pressure Control	48
4.5.3	Vent.....	48
4.6	Graphical User Interface Menus.....	48
4.6.1	Shortcuts	48
4.6.2	Menu Structure.....	48
4.7	Menu operation.....	50
4.7.1	AutoRange.....	50
4.7.2	AutoTest	51
4.7.2.1	Exercise	52
4.7.2.2	Quick Test.....	53

4.7.2.3	Advanced Test	54
4.7.3	Pressure	58
4.7.3.1	Purge	58
4.7.3.2	Leak Test	59
4.7.4	Drivers	60
4.7.5	System	60
4.7.5.1	Control Configuration	60
4.7.5.2	Reset	60
4.7.6	Pressure	62
4.7.6.1	Pressure Unit	62
4.7.6.2	Measurement Mode	63
4.7.6.3	Head	64
4.7.6.4	Resolution	65
4.7.7	Preferences	65
4.7.7.1	Screen Saver	65
4.7.7.2	Sounds	66
4.7.7.3	Time	66
4.7.7.4	Language	66
4.7.7.5	Security	67
4.7.7.6	Edit Security Password	67
4.7.8	Control	68
4.7.8.1	Pressure Limits	68
4.7.8.2	Pressure Control	69
4.7.8.3	Jog Step	69
4.7.9	Remote	70
4.7.9.1	Command Format	70
4.7.9.2	IEEE-488	71
4.7.10	Calibration	71
4.7.11	Uncertainty	71
4.7.12	Internal	71
4.7.12.1	ID	71
4.7.12.2	Control Reference	71
4.7.12.3	Purge	72
4.7.12.4	Event log	72
4.7.12.5	TEST (-) Vent	73

5. Remote Operation 75

5.1	Overview	75
5.2	Remote Interfacing	75
5.2.1	RS232 Interface	75
5.2.1.1	COM1	75
5.2.1.2	COM2	76
5.2.1.3	RS232 Command Testing	76
5.2.2	IEEE-488	79
5.2.2.1	IEEE-488 Remote Command testing	79
5.3	Programming Formats	80
5.3.1	Classic Program Message Format	80
5.3.2	Enhanced Program Message Format	81
5.3.2.1	Using Command Type Commands	81
5.3.2.2	Using Query Type Commands	82
5.4	Commands	83
5.4.1	Programming Messages	83
5.4.2	Error Messages	85
5.4.3	Program Message Description Overview	86
5.4.4	Program Message Descriptions	87
5.5	Status Reporting System	116
5.5.1	Error Queue	116
5.5.2	Status Byte Register	116
5.5.3	Standard Event Register	117
5.5.4	Ready Status Register	118
5.6	IEEE STD. 488.2 Common and Status Program Messages	118
5.6.1	Program Message Descriptions	119

6.	Maintenance, Adjustments and Calibration.....	123
6.1	Overview	123
6.2	Calibration of Reference Pressure Transducers	123
6.2.1	Principle.....	123
6.2.1.1	PA and PM Coefficients	124
6.2.1.2	As Received and As Left Data.....	124
6.2.2	Equipment Required	125
6.2.3	Set-up and Preparation.....	125
6.2.4	Recommended Calibration Point Sequence.....	126
6.2.4.1	Recommended Calibration Point Sequences for PPC4E RPTs	126
6.2.5	Turning Off Absolute and Negative Gauge Measurement Modes	128
6.2.6	RPT Calibration using CalTool for RPTs Software.....	128
6.2.7	Editing and Viewing RPT Calibration Information.....	129
6.2.7.1	RPT Uncertainty	129
6.2.8	RPT Calibration/Adjustment without CalTool for RPTs Software	130
6.3	Adjustment of an On-board Barometer	131
6.4	Pneumatic Control Module Configuration.....	131
6.5	Reloading Embedded Software into Flash Memory	132
6.6	Removing the PPC4E Cover.....	133
6.7	Overhaul.....	133
6.8	Subassembly Description and Location	134
6.8.1	Power Supply Module	135
6.8.2	PowerPC Board	135
6.8.3	RPT MODULE	135
6.8.3.1	Hi RPT	135
6.8.3.2	Lo RPT.....	135
6.8.4	On-board Barometer	135
6.8.5	Vacuum Sensor	135
6.8.6	Pressure Control Module.....	136
6.8.7	Display	136
6.8.8	Driver Board	136
6.9	Pneumatic Schematics	136
6.9.1	PPC4E Pressure Control Module	136
6.9.2	PPC4E Reference Pressure Transducer Module Configurations.....	137
7.	Troubleshooting.....	139
8.	Appendix.....	143
8.1	Drivers	143
8.2	Unit Conversion.....	144
8.2.1	Pressure	144
9.	Limited Warranty and Limitation of Liability.....	145
10.	Glossary	147

Tables

Table 1. PPC4E Model Designations and Ranges	2
Table 2. PPC4E Measurement Uncertainty (Includes Precision)	3
Table 3. PPC4E Packing List.....	5
Table 4. Position Designators of RPTs in a PPC4E System	17
Table 5. Settings and What They Are Specific To (Range, Measurement Mode, RPT, System)	18
Table 6. Settings Made by AutoRange	19
Table 7. Default Pressure Control Parameters!!!	23
Table 8. Reset Settings	30
Table 9. Reset Calibration.....	31
Table 10. Reset All.....	31
Table 11. Security Levels, Advanced Interface.....	34
Table 12. Main Run Screen Fields and Buttons	42
Table 13. Lower Level Screen Displays and Selectable Fields	43
Table 14. Menu Structure.....	49
Table 15. COM1 Pin Designations and Connections	75
Table 16. COM2 DB-9F Pin Designations	76
Table 17. Program Message List	83
Table 18. Error #s and Descriptions	85
Table 19. 8 Bit Status Byte Register	116
Table 20. 8 Bit Standard Event Register.....	117
Table 21. 8 Bit Ready Status Register.....	118
Table 22. Program Message List	118
Table 23. Calibration Point Sequence, A200K RPTs	127
Table 24. Calibration Point Sequence, A1.4M and A700K RPTs	127
Table 25. Calibration Point Sequence, A7M and A14M RPTs	127
Table 26. Calibration Point Sequence, BG15K RPTs.....	127
Table 27. PPC4E Troubleshooting Guide.....	139
Table 28. External Drivers Current Output.....	143
Table 29. External Drivers Pin Outs.....	143
Table 30. Pressure Unit of Measure Conversion Coefficients	144
Table 31. Fluke Calibration Authorized Service Providers	146

Figures

Figure 1. PPC4E front panel	7
Figure 2. PPC4E rear panel	7
Figure 3. Dynamic Pressure Control Operation	14
Figure 4. Static Pressure Control Operation	15
Figure 5. <i>Ready/Not Ready</i> in Dynamic Pressure Control Mode	16
Figure 6. <i>Ready/Not Ready</i> in Static Control Mode	16
Figure 7. Main Run Screen Display and Selectable Fields (see Table 12)	41
Figure 8. Lower Level Screen Example (see Table 13).....	43
Figure 9. Keypad layout	44
Figure 10. AutoRange Bar	51
Figure 11. Windows selection of Hyperterminal.....	76
Figure 12. Hyperterminal Initial Display	76
Figure 13. Hyperterminal ASCII Setup.....	78
Figure 14. Status Register Schematic	116
Figure 15. Removing Back Cover	133
Figure 16. PPC4E Internal View	134
Figure 17. Pressure Control Module Schematic	136
Figure 18. PPC4E Reference Pressure Transducer Module Schematics	138
Figure 19. Drivers Connector Schematic	143

About This Manual

This manual is intended to provide the user with the basic information necessary to operate a PPC4E pressure controller/calibrator. It also includes a great deal of additional information provided to allow you to optimize PPC4E use and take full advantage of its many features and functions.

Before using the manual, take a moment to familiarize yourself with the Table of Contents structure: Sections 1, 2 and 3 should be read by all first time PPC4E users. Section 4 is important for those using the Advanced user interface. Section 5 is for remote operation from an external computer. Section 6 provides maintenance and calibration information. Section 7 is a quick troubleshooting guide. Use it to troubleshoot unexpected PPC4E behavior based on the symptom of that behavior. Certain words and expressions have specific meaning as they pertain to PPC4E. The Glossary, Section 10 is useful as a quick reference for exact definition of specific words and expressions as they are used in the manual.

Note

For those who “don’t read manuals”, go directly to Section 2.3 to set up your PPC4E and then go to Section 2.4 for power-up and verification. This will get you up and running quickly with a minimal risk of causing damage to yourself or your new PPC4E. THEN...when you have questions or start to wonder about all the great features you might be missing, get into the manual!

Manual Conventions

Note

- This manual is written for both PPC4E and PPC4EX. PPC4EX is a configuration of PPC4E with extended AutoRange turndown.
- When the term “PPC4E” is used alone, it typically refers to both PPC4E and PPC4EX collectively.
- Detailed description of menu structure, key press sequences and conventions are found in Section 4.
- For dedicated front panel keys, such as **ESC**, **VENT**, **SET P**, and **ENTER**, any time a key is shown in the manual, it should be interpreted to mean “press this key”. For example: **ESC** to return to the Main Run Screen means “Press the **ESC** button to return to the Main Run Screen”.
- The electronic version of this manual makes extensive use of hot links for the table of contents, figure references, table references and all section references found throughout. Simply click on a reference to follow the live link.

⚠ Caution

“Caution” is used throughout the manual to identify conditions or actions that could cause harm to the PPC4E or to the devices that are connected to the PPC4E.

⚠ Warning

“Warning” is used in throughout the manual to identify actions that could pose a hazard to the user of the PPC4E.

Note

“Note” is used throughout the manual to identify operating and applications advice and additional explanations.

1. Introduction

1.1 Product Overview

PPC4E is a stand-alone pressure controller intended for precision setting and control of gas pressure into a closed volume as is commonly needed for the calibration and testing of pressure measuring instruments. It has been designed to provide very high performance combined with versatility and ease of use.

Model “PPC4E” is equipped one Reference Pressure Transducers (RPT) and model PPC4EX is equipped with two RPTs to allow it to set and measure pressure with low measurement uncertainty.

Pressure control is achieved by a patented pneumatic module based on digitally controlled solenoid valves and differential pressure regulators.

PPC4E is controlled locally by the operator using a front panel display, keypad and function keys or remotely by a computer using ASCII character command strings over RS232 or IEEE-488.2.

PPC4E models are available to support measure and control pressure in ranges from as low as - 1 to 1 kPa (-0.15 to 0.15 psi) to as high as 14 MPa (2 000 psi), and feature absolute, gauge and compound gauge pressure measurement modes.

1.2 Specifications

1.2.1 General Specifications

Power Requirements	100 to 240 VAC (-15%, +10%), 50-60 Hz, 70 VA max consumption
Operating Temperature Range	10 to 40 °C
Storage Temperature Range	-20 to 70 °C
Vibration	Meets MIL-PRF-28800F Class 3
Weight	16.6 kg (36.5 lb)
Dimensions	19 cm H x 35 cm W x 45 cm D (7.5 in. x 13.8 in. x 17.7 in.)
Ventilation	To prevent product overheating, provide proper ventilation. Allow 10 cm (4 in.) clearance from rear panel cooling fan.
Microprocessors	Motorola 68302, 16 MHz
Remote communication interfaces	RS232 (COM1, COM2), IEEE-488.2, USB (front panel, firmware load only)
Fuses	1 A, 250 VAC fuse, 5 x 20 mm, time lag type fuse. Internal power supply fuse not replaceable by operator: 2A, 250 V (UV 440-2 power supply), 3.15A, 250 V (NFS40-7612 power supply)
Pressure Ranges	Vacuum to 14 MPa (2 000 psi) see Table 1.
Operating Medium	Any clean, dry, non-corrosive gas

⚠ Warning

User is responsible for any and all safety precautions associated with hazardous, flammable or toxic gas ventilation and containment.

Pressure Connections	TEST (+), TEST (-): 1/8 in. NPT F SUPPLY: 1/8 in. NPT F EXHAUST: 3/8 in. NPT F ATM: 10-32 UNF
Pressure Limits	Maximum working pressure: PPC4E range maximum Maximum test pressure w/out damage: 115 % of PPC4E range Recommended supply pressure: Maximum control pressure + 10 %

1.2.2 Pressure Measurement Specifications

1.2.2.1 PPC4E Models and Ranges

PPC4E family of pressure controller/calibrator measurement and control ranges are achieved by using one internal reference pressure transducer (RPT) in PPC4E models and two RPTs in PPC4EX models. PPC4E and PPC4EX models with similar numeric model designations cover similar maximum pressure ranges, however the uncertainty of pressure measurements at the low end of the pressure range is a function of the AutoRanged Span (see Section 3.2.7). Uncertainties scale with AutoRanged spans as low as 10% of the controller span for PPC4E models and as low as 1% of the controller span for PPC4EX models.

All PPC4E and PPC4EX models have only one TEST(+) and TEST(-) port. PPC4E internal valves and logic handle switching between the two RPTs as needed.

Table 1. PPC4E Model Designations and Ranges

MODEL DESIGNATION	Hi RPT	Lo RPT	PRESSURE RANGE ¹			
			Gauge [kPa] ²	Gauge [psi] ²	Absolute [kPa]	Absolute [psi]
PPC4EX 14M	A14M	A1.4M	-ATM to 14 000	-ATM to 2 000	0 to 14 000	0 to 2 000
PPC4E 14M	A14M	-				
PPC4EX 7M	A7M	A700K	-ATM to 7 000	-ATM to 1 000	0 to 7 000	0 to 1 000
PPC4E 7M	A7M	-				
PPC4EX 1.4M	A1.4M	A200K	-ATM to 1 400	-ATM to 200	0 to 1 400	0 to 200
PPC4E 1.4M	A1.4M	-				
PPC4EX 100K	A200K	BG15K	-ATM to 100	-ATM to 15	0 to 200	0 to 30
PPC4E 100K	A200K	-				
PPC4E 15K	BG15K	-	±15	±2.2	-	-

¹ Pressure range is nominal measurement range. See pressure control specifications (Section 1.2.3) for lowest controllable pressure.

² ATM represents the current atmospheric pressure. -ATM is the lowest pressure achievable in negative gauge mode (vacuum).

Warm Up Time	None required, 30 minute temperature stabilization recommended for best performance from cold power up
Resolution	To 1 ppm, user adjustable
Acceleration Effect	± 0.008 % /g maximum, worst axis Allows operation at ± 20° from reference plane without significant effect
Predicted One Year Stability	± 0.005% of reading for gauge or negative mode or ± (0.005% + Constant uncertainty from Table 2) for absolute mode, k=2
Precision	0.019% of AutoRanged span or better for AutoRanged span equal to or greater than the Minimum AutoRanged span (see Table 2).

Table 2. PPC4E Measurement Uncertainty (Includes Precision)

Model	Gauge Uncertainty ¹ Equal to % of AutoRanged span ³		Absolute Uncertainty ¹ Equal to % of AutoRanged span + Constant ⁴		
	% of AutoRanged span	Minimum AutoRanged span [kPa] ²	% of AutoRanged span	Constant [kPa]	Minimum AutoRanged span [kPa] ²
PPC4EX 14M	0.02	140	0.02	0.1	140
PPC4E 14M	0.02	1 400	0.02	1	1 400
PPC4EX 7M	0.02	70	0.02	0.05	70
PPC4E 7M	0.02	700	0.02	0.5	700
PPC4EX 1.4M	0.02	14	0.02	0.014	70
PPC4E 1.4M	0.02	140	0.02	0.1	140
PPC4EX 100K	0.02	± 1	0.02	0.014	70
PPC4E 100K	0.02	± 10	0.02	0.014	70
PPC4E 15K	0.02	± 1.5	-	-	-

1. Maximum deviation of the RPT indication from the true value of applied pressure including precision, predicted one year stability limit, temperature effect and calibration uncertainty, combined and expanded (k=2) following the ISO "Guide to the Expression of Uncertainty in Measurement."

2. For AutoRange spans below the Minimum AutoRanged span uncertainty is equal to the value at the Minimum AutoRanged span.

3. Gauge uncertainty is a % of AutoRanged span. For example, an AutoRanged span of 3 500 kPa on model PPC4E 7M would have uncertainty of (0.02% * 3 500 kPa) = 0.70 kPa.

4. Absolute uncertainty is the sum of a % of AutoRanged span and a Constant that accounts for zero drift. For example, an AutoRanged span of 80 kPa on model PPC4EX 100K would have uncertainty of (0.02% * 80 kPa + 0.014 kPa) = 0.03 kPa.

1.2.2.2 On-Board Barometer

The on-board barometer is used only to measure changes in atmospheric pressure to provide dynamic compensation of an absolute RPT's atmospheric pressure offset in gauge measurement mode with PPC4E models other than PPC4E 15k.

Warm Up Time	None required
Range	70 to 110 kPa (10 to 16 psi)
Resolution	0.001 % of span
Precision	0.14 kPa

1.2.3 Pressure Control Specifications

Control Precision	<p>PPC4E: ±0.0006% of controller span</p> <p>PPC4EX: ±0.0006% of controller span (AutoRanged span >10% of controller span) ±0.00006% of controller span (AutoRanged span ≤10% of controller span)</p>
Lowest controllable Pressure (gauge mode)	Zero set by automated venting. Lowest point above or below zero limited only by RPT resolution and control precision.
Lowest controllable Pressure (absolute, negative gauge modes)	<p>1 kPa for all models except PPC4E 7M and PPC4E 14M</p> <p>3.5 kPa for PPC4E 7M</p> <p>7 kPa for PPC4E 14M</p>
Ultimate Pressure (absolute, negative gauge) Depending on vacuum pump and connections	200 to 700 Pa (2 to 7 mbar, 0.03 to 0.1 psia)
Typical Pressure Setting Ready Time (0.005% hold limit, 50 cc test volume)	15 to 30 s
Slew Time (ATM to FS with 50 cc test volume)	30 s
Typical Test Volume	0 to 1000 cc for Controller Range of 1.4 MPa [300 psi] or less 0 to 500 cc for Controller Range greater than 1.4 MPa [300 psi]
Default Dynamic Control Hold Limit	± 0.01 % of current range

2. Installation

2.1 Unpacking and Inspection

2.1.1 Removing from Packaging

PPC4E is delivered in a corrugated container with suspension packaging; or in an optional molded shipping case with custom foam inserts.

Remove the PPC4E and its accessories from the shipping container and remove each element from its protective plastic bag.

2.1.2 Inspecting Contents

Check that all items are present and have no visible damage.

A PPC4E includes all items indicated in Table 3.

Table 3. PPC4E Packing List

DESCRIPTION		PART #
	PPC4E Pressure Controller/Calibrator (one of listed models):	
	PPC4E 14M	3842637
	PPC4EX 14M	3842628
	PPC4E 7M	3842619
	PPC4EX 7M	3842604
	PPC4E 1.4M	3842598
	PPC4EX 1.4M	3842580
	PPC4E 100K	3842571
	PPC4EX 100K	3842567
	PPC4E 15K	3842559
1 ea.	Calibration Certificate	3152121
1 ea.	Test Report	3126112
ACCESSORIES:		3846495
1 ea.	User Manual	3890723
1 ea.	Drivers Connector	3069838
1 ea.	USB Cable, 2 Meter, Shielded	1626219
1 ea.	Power Cord (7.5 ft.)	3133781
1ea.	Power Cord, CE (7.5 ft.)	3153005
1 ea.	General Accessories CD	3139043
2 ea.	Bulkhead Retainer, ½ in. hex	3138166
2 ea.	M4 Split Lock Washer	3153914
2 ea.	M4 x 8 Screw, BHSC	3361394
2 ea.	M3 x 20 Screw, SHC	3133921

2.2 Site Requirements

The PPC4E can be installed on any **flat, stable surface** at a convenient height. The front feet can be extended so that the unit can be inclined for easier viewing. The PPC4E can also be mounted in a standard 19 in. rack using the optional rack mount kit.

Minimizing the distance between the PPC4E and the device or system under test will enhance control performance and reduce pressure setting times.

Ready access to the PPC4E rear panel should be considered to facilitate making and breaking pressure connections.

The Self Purging Liquid Trap (SPLT), if used, should be mounted vertically at the low point of the connection between the PPC4E **TEST(+)** port and the test (see Section 2.3.6.1).

PPC4E 15K and PPC4EX 100K must be set up with a Dual Volume Unit (DVU). Its location and connections should be considered (see Section 2.3.6.2).

Support facilities required include:

- **An electrical power source** of 100 to 240 VAC, 50 - 60 Hz.
- **A continuous, regulated pressure supply** of clean, dry, non-corrosive gas at PPC4E maximum control pressure + 10 % (70 kPa (10 psi) in the case of a PPC4E 15K) to be connected to the PPC4E **SUPPLY** port. Lower gas pressure supply can be used but should exceed the maximum desired test output pressure by 10 to 20 %.
- **A vacuum source** of less than 1 psi absolute (7 kPa) and with displacement of at least 90 lpm (3 cfm) if control of pressures under 3 psi (20 kPa) gauge is desired.

2.3 Setup

2.3.1 Preparing for Operation

To prepare PPC4E for check out and operation:

- ❶ Remove the plastic caps from the PPC4E rear panel pressure connections.
- ❷ Remove the protective plastic sheet from the front panel display.
- ❸ Familiarize yourself with the front and rear panel (see Section 2.3.2).

Then proceed with Sections 2.3.3 to 2.3.9.

2.3.2 Front and Rear Panels

2.3.2.1 Front Panel

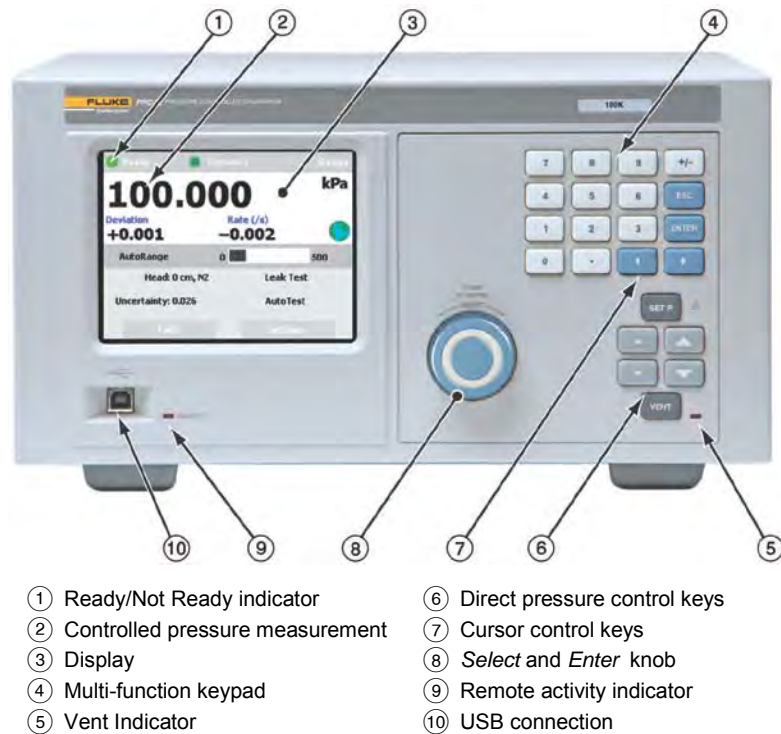

Figure 1. PPC4E front panel

2.3.2.2 Rear Panel

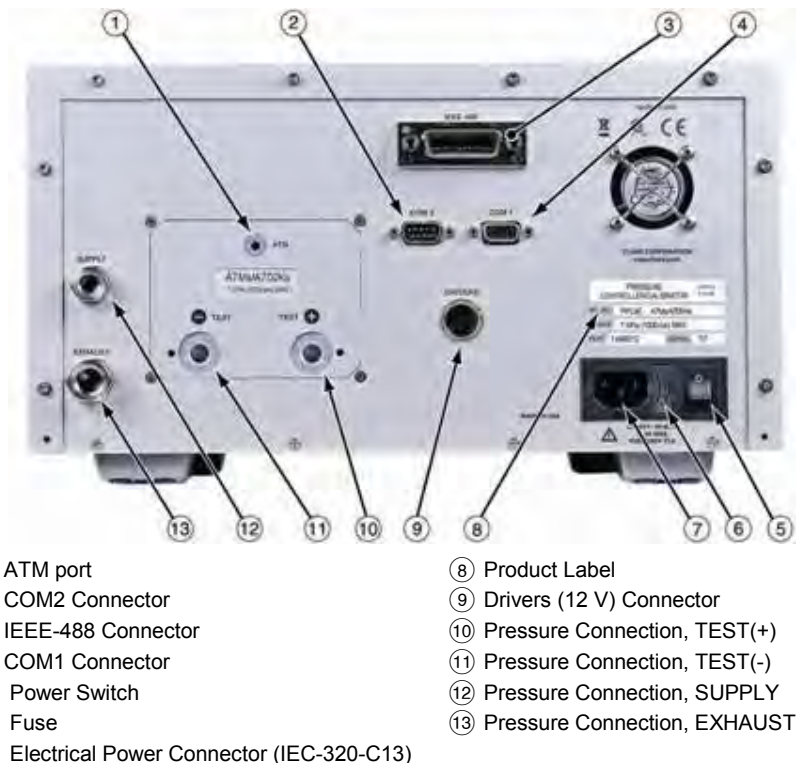

Figure 2. PPC4E rear panel

2.3.3 Power Connection

- ❶ Check that the PPC4E power switch is OFF.
- ❷ Connect the supplied power cable to the rear panel power module.
- ❸ Connect the other end of the power cable to an electrical supply of 100 to 240 VAC, 50-60 Hz.

2.3.4 Connecting to a Pressure Supply (Supply Port)

Using a pressure connecting hose or tube of appropriate pressure rating, connect the pressure supply to the **SUPPLY** port on the rear panel of PPC4E. The PPC4E **SUPPLY** port connection is **1/8 in. NPT female**.

The supply pressure should be equal to the maximum PPC4E control pressure + 10 % (or 70 kPa (10 psi) for a PPC4E 15K). Lower gas pressure sources can be used but should exceed the maximum desired test output pressure by 10 to 20 %.

Caution

Never connect a pressure supply greater than 20 % over the maximum pressure of the PPC4E maximum pressure range (except with PPC4E 15K as specified). Be sure to connect the pressure supply to the SUPPLY port. Connecting to another port can damage the PPC4E.

2.3.5 Connecting a Vacuum Pump (Exhaust Port)

For PPC4E to set pressures under atmosphere and/or to reliably set pressure under 20 kPa (3 psi) gauge (other than zero gauge), a vacuum supply must be connected to the **EXHAUST** port.

Caution

- **Never connect a pressure supply to or plug the PPC4E EXHAUST port.**
- **To avoid building up pressure on the EXHAUST port or on a vacuum pump connected to the EXHAUST port, the vacuum source should either be continuously ON or the EXHAUST port should be bypassed to atmosphere when the vacuum source is OFF. This is because when a supply pressure is applied to the PPC4E SUPPLY port and the PPC4E is NOT in the vent ON condition, there is typically a constant gas exhaust through the PPC4E EXHAUST port.**

Note

To ensure optimum pressure control when changing the pressure applied to the EXHAUST port from vacuum to atmosphere or vice-versa, be sure to change the control reference setting if the setting is NOT in AUTO mode (see Section 3.2.25.1).

2.3.6 Connecting to the Device Under Test (Test(+) and Test(-) Ports)

If you are using a self purging liquid trap (SPLT), see Section 2.3.6.1 before proceeding to connect the device under test.

If the PPC4E is model PPC4E 15K or PPC4EX 100K, a dual volume unit (DVU) should be installed for very low pressure control. See Section 2.3.2.2 before proceeding to connect to the device under test.

Using a pressure connecting hose or tube of appropriate pressure rating, connect the device or system to be tested to the PPC4E **TEST(+)** port. The PPC4E **TEST(+)** connection is **1/8 in. NPT female**.

PPC4E TEST(+) AND TEST(-) PORTS

All PPC4Es have a **TEST(+)** and a **TEST(-)** port. See Figure 18 for configuration of Reference Pressure Transducers (RPTs) and the internal barometer in the different PPC4E models.

- **When operating in absolute mode:** The **TEST(-)** port is left open to atmosphere.
- **When operating in gauge or negative gauge mode with a range greater than 50 kPa (7.5 psi):** The **TEST(-)** port is normally left open to atmosphere. A possible exception is when the device or system under test is in an ambient pressure that may differ significantly from the ambient pressure around the PPC4E. For example, if the PPC4E is controlling pressure into UUTs in an environmental chamber, the pressure in the environmental chamber may be different from ambient pressure around the PPC4E. In this case, connecting a tube from the **TEST(-)** port to the inside of the chamber may improve measurement results. This tube must be left open to the environment so that the pressure inside cannot deviate too far from ambient.
- **When operating in gauge or negative gauge mode with a range less than 50 kPa (7.5 psi):** As a general rule, it is preferable to connect the PPC4E **TEST(-)** port(s) directly to the low or reference side of the device under test to ensure that these are at the same pressure. In most cases, this tube must be left open to the environment so that the pressure inside cannot deviate too far from ambient. The exception is when using a PPC4E 15K or PPC4EX 100K AutoRanged to 10 kPa or less, for which more stable results may be obtained by closing this connection off from ambient pressure to reduce line pressure fluctuations.

⚠ Caution

- **Do not apply pressure to the TEST(+) port without having a pressure supply equal to or greater than the applied pressure connected to the SUPPLY port. When controlling pressure to the TEST(+) port externally, do not cause the pressure to change at a rapid rate. For example, do not vent suddenly by opening an external valve. Internal damage to the PPC4E may result.**
- **Do not connect a pressure supply to the TEST(-) port. The pressure applied to this port should be maintained at atmospheric pressure, between 70 and 110 kPa (10 and 16 psia). Exceeding these limits may damage the PPC4E.**
- **Operating the PPC4E connected to a system with liquid contaminants without taking proper precautions to purge the system and test line may cause contamination of the PPC4E that will require non-warranty service.**

Note

- **Minimizing the length of the test connection tubing will enhance control performance and reduce pressure setting time. For normal operation, the total volume of the device or system under test including connecting tubing should be less than 1 000 cc (60 in³) up to 2 000 kPa (300 psi) and less than 500 cc (30 in³) above 2 000 kPa (300 psi).**
- **PPC4E pressure control will not operate properly if there are excessive leaks in the test system. In general, the maximum acceptable leak rate for optimal PPC4E automated pressure control operation and to ensure in tolerance measurements with default pressure control parameters is $\pm 0.5\%$ of set pressure/minute. In DYNAMIC CONTROL mode, to handle higher test system leak rates, increase the hold limit using CUSTOM CONTROL (see Section 3.2.12).**
- **PPC4E pressure control may be adversely affected if the test connection tubing is too restrictive. For optimum results, the inner diameter of the connecting hose should be at least 1.75 mm (0.07 in.).**

2.3.6.1 Installing a Self Purging Liquid Trap (SPLT)

The SPLT (optional) is intended to collect and exhaust liquid or other contaminants that may be present in the device or system under test so that they do not return to contaminate the PPC4E.

The SPLT is installed in the **TEST(+)** connection line at a low point between PPC4E and the device or system under test.

See the SPLT Operation and Maintenance manual for more complete instructions on SPLT installation.

2.3.6.2 Installing a Dual Volume Unit (DVU), PPC4E 15 K and PPC4EX 100K

To achieve in tolerance pressure control with the very low range of the PPC4E 15K and PPC4EX 100K, a PK-PPC-BG-DVU dual volume unit should be installed in-line on the **TEST(+)** and **TEST(-)** ports. The DVU includes two thermally isolated volumes installed in the test line to improve control stability.

See the PK-PPC-BG-DVU instruction sheet for additional information on its installation.

2.3.7 The ATM Port

The PPC4E **ATM** port is the system vent to atmosphere point used to set zero gauge pressure as well as to obtain reference pressure measurements of atmospheric pressure. Although a pressure hose can be connected to the **ATM** port to direct the vented gas flow, a completely unobstructed connection to atmosphere must be maintained for PPC4E reference pressure measurements to operate normally.

The PPC4E **ATM** port fitting is **10-32 UNF**.

⚠ Caution

NEVER plug, obstruct or connect a supply pressure to the PPC4E ATM port. This may adversely affect GAUGE mode operation.

2.3.8 Check/Set Security Level

PPC4E has a security system based on user levels. By default, the security system is set to “low”, which includes certain access restrictions, and there is no password required to change the security level. See Section 3.2.24.4 for information on the security level system. As part of the PPC4E startup, determine the security level that is appropriate for the PPC4E and set a password if desired.

⚠ Caution

PPC4E is delivered with the security level set to “low” to avoid inadvertent altering of critical internal settings but with access to changing security levels unrestricted. It is recommended that the low security level be maintained at all times and password protection be implemented if control over setting of security levels is desired.

2.3.9 Turn Off Absolute and Negative Gauge Mode

Most PPC4E onfigurations are able to operate in gauge, negative gauge and absolute measurement modes (see Section 3.2.10). PPC4E 15K operates only in gauge or negative gauge mode. If the PPC4E will be used only in gauge mode, the other measurement modes can be turned off so they are no longer accessible. This can avoid confusion and/or accidental use of the wrong measurement mode. See Section 0 for complete information on turning off absolute and negative gauge measurement modes.

2.4 Power-Up And Verification

2.4.1 Switch Power On

Actuate the power switch on the PPC4E rear panel. Observe the front panel display as PPC4E initializes error checks and goes to the Main Run Screen (see Section 4.1).

PPC4E power-up condition is ranged to the PPC4E maximum pressure, VENT ON unless the pressure measured by the active reference pressure transducer is more than 20 kPa (3 psi) away from standard atmospheric pressure.

If the PPC4E fails to reach the Main Run Screen, service is required. Record the sequence of operations and displays observed.

2.4.2 Check Pressure Measurement Operation

2.4.2.1 Checking Absolute Mode Pressure Measurement

If the PPC4E is not vented (VENT LED OFF), **VENT** to vent the PPC4E (VENT LED ON) (see Section 3.2.13) and wait for a *Ready* indication (see Section 3.2.3).

Use the PPC4E AutoRange function to select or configure an absolute pressure range near the maximum pressure of the PPC4E (see Section 4.7.1). Verify the PPC4E is vented. Observe the current value of atmospheric pressure. Check that the value agrees with the local value of atmospheric pressure within PPC4E measurement tolerance as applicable (see Section 1.2.3). If they do not agree within tolerances, the PPC4E may require repair or calibration.

If the PPC4E is model PPC4EX 1.4M, PPC4EX 7M or PPC4EX 14M, use the PPC4E AutoRange function to select or configure gauge pressure range near 8% of the maximum absolute pressure of the PPC4E (see Section 4.7.1). Verify the PPC4E is vented. Check that the value agrees with the local value of atmospheric pressure within PPC4E measurement tolerance as applicable.

2.4.2.2 Checking Gauge Mode Pressure Measurement

If the PPC4E is not vented, **VENT** to vent it (see Section 3.2.13).

Note

It is normal for PPC4E to indicate a value other than zero when vented when gauge mode is first entered or ranges are changed. After about ten seconds, the vent LED should flash and zero should be indicated.

Use the PPC4E AutoRange function to select or configure gauge pressure range near the maximum pressure of the PPC4E (see Section 4.7.1). Verify the PPC4E is vented. Observe that, within ten seconds, zero pressure is indicated. It is normal for PPC4E to indicate a value other than zero for up to ten seconds when first entering gauge mode.

If a "PPC4EX" model, use the PPC4E AutoRange function to select or configure gauge pressure range near 5% of the maximum gauge pressure of the PPC4E (see Section 4.7.1). Verify the PPC4E is vented. Observe that, within ten seconds, zero pressure is indicated.

2.4.3 Leak Test

If desired, perform a leak check of the test system (see Section 3.2.17).

2.4.4 Purge

If an SPLT is included and installed in the test line (see Section 2.3.6.1) and the Device Under Test (UUT) may be contaminated with liquids, perform a purge of the UUT (see Section 3.2.25.4). The Purge function must first be enabled (see Section 4.7.12.3). This will help to expel contaminating liquids from the UUT.

Caution

Operating the PPC4E connected to a system with liquid contaminants without taking proper precautions to purge the system and test line may cause contamination of the PPC4E that will require non-warranty service.

2.4.5 Check Pressure Control Operation

Select a pressure range using **[AutoRange], Range:** (see Section 4.7.1).

Select dynamic control mode with the control mode shortcut (see 4.6.1 and Section 4.7.8.2). **ENTER** to return to the Main Run Screen.

SET P, key in a target pressure within the active range and **ENTER**. (see Section 4.5.1).

Caution

Verify the maximum pressure rating of the system connected to the PPC4E TEST(+) port before entering a target pressure. Do not enter a target pressure greater than the pressure rating of the system connected to the PPC4E TEST(+) port.

PPC4E should set the target pressure and indicate *Ready* (see Section 3.2.3) continuously in 15 to 60 seconds. If it does not, see Section 7 to troubleshoot.

2.5 Short Term Storage

The following procedure is recommended for short term storage of PPC4E:

- 1 Vent the PPC4E test pressure.
- 2 Turn the power OFF using the rear panel power switch.
- 3 Shut OFF or disconnect the pressure supply.
- 4 Shut OFF or disconnect the vacuum supply. Be sure the pressure supply is disconnected or the vacuum pump is bypassed from the PPC4E **EXHAUST** port before turning OFF the vacuum pump.

3. Operating Principles

3.1 User Interface

PPC4E features a graphical user interface for bench top operation, and remote communications for computer controlled applications such as automated calibration or testing. See Section 4 for operation information when using the graphical user interface.

Remote communication is by RS232 (COM1) or IEEE-488. See Section 5 for specific information on remote communication.

3.2 General Operating Principles

3.2.1 Direct Pressure Control

○ PURPOSE

The direct pressure control keys provide direct manual control to increase, decrease, and jog the PPC4E pressure.

○ OPERATION

▲ or ▼ cause pressure to increase or decrease at the fast slew rate.

▲ or ▼ when dynamic control is not active cause pressure to increase or decrease at the slow slew rate.

▲ or ▼ during dynamic control causes the pressure to jog or step by a fixed amount. During active pressure control, they cause the target pressure to be changed by the fixed amount. One press causes one step. The approximate value of the step is set automatically depending on the current active PPC4E range. The value can be adjusted with the Jog function (see Section 3.2.18).

⚠ Caution

The fast direct pressure control keys, ▲ and ▼, interrupt and override automated pressure control.

3.2.2 Automated Pressure Control

PPC4E automated pressure control provides automated adjustment and control of pressure to a user designated target value. **SET P** from the Main Run Screen allows a pressure control target value to be entered and executed. **ESC** or **SET P** cause active pressure control to be interrupted. Sending a remote command when in local mode also interrupts pressure control.

PPC4E supports two pressure control modes to meet different pressure setting and controlling requirements: dynamic and static. Pressure control parameters for each control mode are automatically set to optimal default values for the operating PPC4E range when the range is selected or AutoRange is used (see Section 3.2.7). Control parameters can be customized using screen selections (see Section 4.7.8.2.1).

Control parameters:

Target Pressure The pressure set point specified by the operator.

Hold Limit A symmetrical positive and negative limit around the target value within which the controlled pressure is maintained.

Stability Limit A rate of change of pressure limit in units of pressure/second used as a criterion for the *Ready/Not Ready* condition in static control or when PPC4E is idle (control not active).

Note

See Sections 3.2.2.1 and 3.2.2.2 (Dynamic Control and Static Control) for a detailed explanation of each control mode and its advantages, the default control parameters and the control customization options.

3.2.2.1 Dynamic Control

Dynamic control mode is designed to set the pressure to the target value and control continuously to keep pressure within the hold limit and as close to the target value as possible (see Figure 3). The advantage of this control mode is that the final pressure achieved is the same as the target value. The maximum value of the control error is equal to the hold limit. The average value of the control error is typically much smaller than the hold limit.

During dynamic pressure control, the hold limit is active. If the pressure goes outside of the hold limit, a *Not Ready* condition occurs. See Table 6 and Table 7 for default hold limit values. To customize the hold limit see Section 4.7.8.2.1.

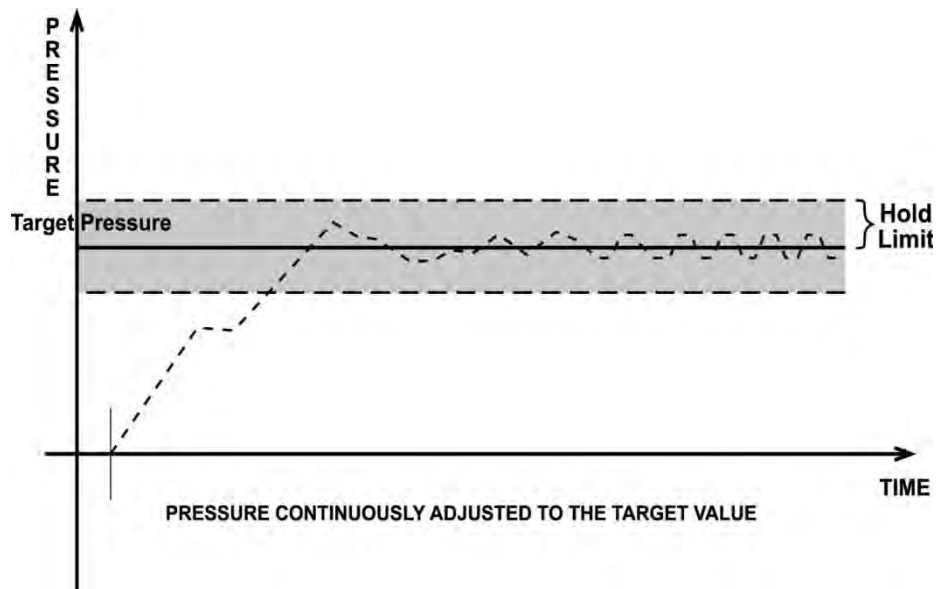

Figure 3. Dynamic Pressure Control Operation

3.2.2.2 Static Control

Static control mode is designed to set the pressure near the target value and then interrupt active control to allow pressure to stabilize naturally within the hold limit. The advantage of this control mode is that pressure can be set and/or measured within a defined limit of a target without interference from the pressure control system. In a system without excessive leaks, the pressure stability achieved may be greater than the stability with which the pressure control system can actively control pressure. Using static control to control pressure near the desired set point and then measuring back the stabilized pressure without interference of the control function can allow control errors to be completely eliminated. However, the final pressure achieved is not equal to the target value. During static pressure control, the hold limit is active. If the pressure goes outside of the hold limit, a *Not Ready* condition occurs (see Section 3.2.3) and pressure is readjusted to the target value (see Figure 4). For default values for hold and stability limits, see Table 6 and Table 7. To customize the hold and stability limits see Section 4.7.8.2.1.

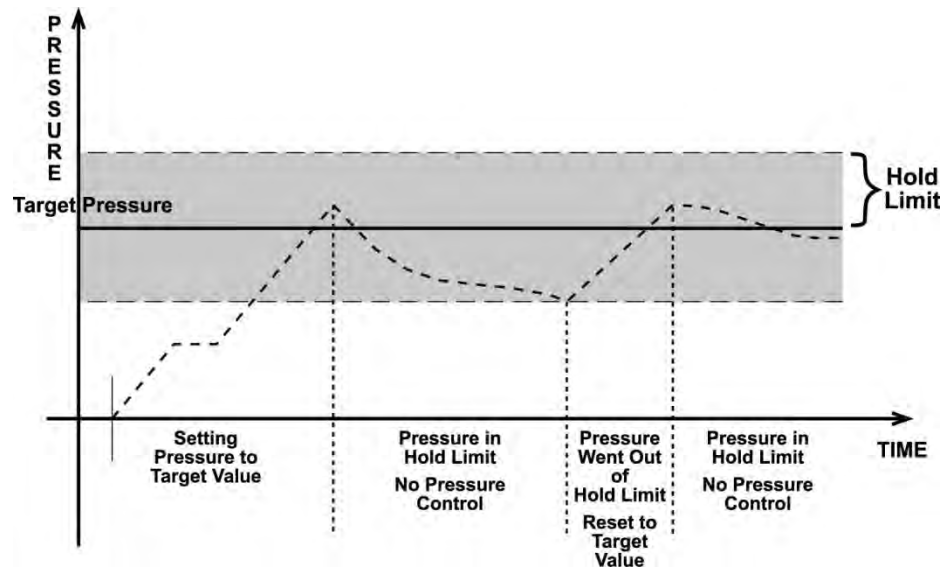

Figure 4. Static Pressure Control Operation

3.2.3 Pressure Ready/Not Ready

A *Ready/Not Ready* indication on the PPC4E display is intended to provide the user with a clear and objective criterion for determining when a valid pressure measurement can be made.

The *Ready/Not Ready* indications are:

- <Green>** Pressure **Ready**. PPC4E is either actively controlling the pressure and the criteria for a *Ready* condition to occur have been met or PPC4E is NOT actively controlling the pressure and the rate of change of pressure is within the stability limit.
- <Yellow>** Pressure **Near Ready**. PPC4E is actively controlling the pressure using fine pressure control and is close to meeting the criteria for a *Ready* condition.
- <Red >** Pressure **Not Ready**. Either PPC4E is idle and pressure does not meet the stability test or PPC4E is actively controlling the pressure and **Ready** conditions have not yet been met.

When pressure control is NOT active: A **Ready** condition occurs any time NO control valve is operating and the pressure rate of change is inside the stability limit. The stability limit is defined in terms of rate of change of pressure in current pressure units per second.

When pressure control is active: The criteria for determining the **Ready/Not Ready** condition depend on whether the current control mode is static or dynamic. Pressure **Ready/Not Ready** parameters are set by default when AutoRange is used, or a control mode is selected. The parameters can be customized if desired (see Section 4.7.8.2.1).

Dynamic Control Ready/Not Ready

With dynamic pressure control active, a **Ready** condition occurs whenever:

- The current measured pressure is inside the hold limit.

Note

In dynamic control mode, it is common to assume that when a **Ready** condition occurs (pressure inside the control hold limit), the measured pressure equals the target pressure. For this reason, when the pressure is **Ready** in dynamic control mode, the measured pressure display is equal to the target pressure.

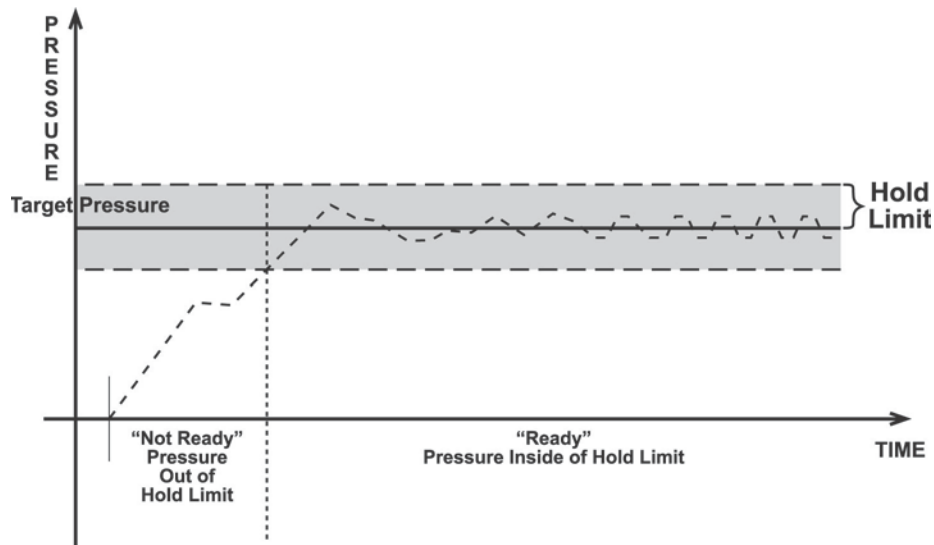

Figure 5. Ready/Not Ready in Dynamic Pressure Control Mode

Static Control Ready/Not Ready

With static pressure control active a *Ready* condition occurs whenever:

- NO control valve is operating.
- The current measured pressure is at the target value within the hold limit.
- The rate of change of pressure is less than the current stability limit.

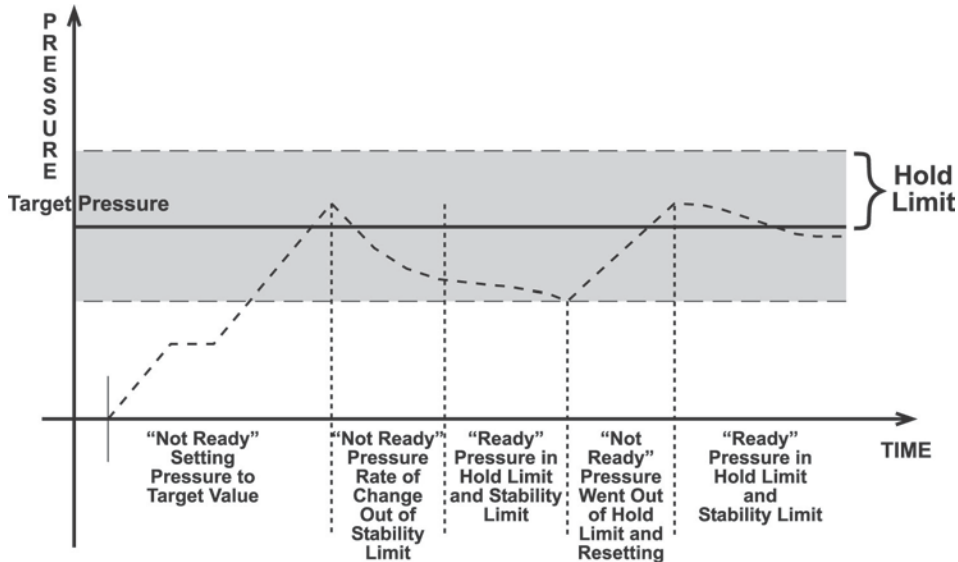

Figure 6. Ready/Not Ready in Static Control Mode

Ready/Not Ready When Not Actively Controlling

When NO automated pressure control is active, *Ready* is indicated whenever the rate of change of pressure is less than the current stability limit (see Section 4.7.8.2.1).

3.2.4 Gauge and Negative Gauge Modes with an Absolute Reference Pressure Transducer, Dynamic Compensation for Atmospheric Pressure

All RPTs used in PPC4E, with the exceptions of the Hi RPT in PPC4E 15K and the Lo RPT in PPC4EX 100K, are intrinsically absolute but they are also used in gauge and negative gauge measurement modes (difference from atmosphere) (see Section 3.2.10). Gauge measurement mode is achieved by subtracting the value of atmospheric pressure, $P_{offset,G}$, from the RPT's

absolute reading. In gauge or negative gauge measurement mode, the routine that measures $P_{\text{offset,G}}$, is run automatically whenever the PPC4E is in the vented condition. This ensures the continuous automated updating of the $P_{\text{offset,G}}$ value corresponding to atmospheric pressure. Gauge pressure is the measured absolute pressure, P_u , minus the atmospheric offset.

$$P_{\text{gauge}} = P_u - P_{\text{offset,G}}$$

However, atmospheric pressure can change between opportunities to update the value of $P_{\text{offset,G}}$, for example when running an extended test without venting. PPC4E uses **dynamic compensation of atmospheric pressure** to correct for these changes in atmospheric pressure. When $P_{\text{offset,G}}$ is determined, the reading of PPC4E's on board barometer, $P_{\text{atm,0}}$, is also recorded. Later, when no longer vented, the change in atmospheric pressure, ΔP_{atm} since $P_{\text{offset,G}}$ was updated is the difference between the current barometer reading, P_{atm} , and the barometer reading at Vent, $P_{\text{atm,0}}$:

$$\Delta P_{\text{atm}} = P_{\text{atm}} - P_{\text{atm,0}}$$

Dynamic compensation for atmospheric pressure uses ΔP_{atm} to correct the value of $P_{\text{offset,G}}$, thus always compensating real time for changes in atmospheric pressure:

$$P_{\text{gauge}} = P_u - P_{\text{offset,G}} - \Delta P_{\text{atm}}$$

Any additional uncertainty in gauge pressure mode due to the dynamic compensation for atmospheric pressure technique is a function of the resolution and short term stability of the on-board barometer rather than its absolute measurement uncertainty. This additional uncertainty is ± 1 Pa (0.00015 psi), and is included in the PPC4E total uncertainty specification.

3.2.5 Multiple RPTs

To obtain low uncertainty, traceable pressure measurement, PPC4E uses Quartz Reference Pressure Transducers (RPT). One or two RPTs can be built into the PPC4E. The use of multiple RPTs (in the case of PPC4EX) is managed by PPC4E transparently to the operator.

The use of multiple RPTs, combined with PPC4E's infinite ranging capability and AutoRange feature (see Section 3.2.7), make it possible for a single PPC4E pressure controller/calibrator system to cover an extremely wide range of test ranges and measurement modes with low uncertainty in each range.

The PPC4E RPT function (see Section 4.7.1, RPT Search) is used to identify RPTs in the PPC4. The PPC4E manages the RPTs transparently to the operator, selecting the appropriate RPT for the range of operation and operating valves to connect and disconnect as needed.

Each RPT has a default range, which is its maximum range. It can also be downranged using PPC4E's AutoRange function.

The PPC4E internal pneumatic layout for handling RPTs depends on the PPC4E model. Figure 18 provides pneumatic schematics of the different PPC4E internal RPT configurations with a chart of valve status for various operating conditions.

Position Identification of RPTs In a PPC4E System

Position identification of the currently active RPT or utility sensor is displayed by selecting [\[AutoRange\]](#) and viewing the **RPT:** field. See **Table 4** for position designation protocol for the RPTs available in a PPC4E system.

Table 4. Position Designators of RPTs in a PPC4E System

RPT POSITION	IDENTIFICATION	DISPLAY SYMBOL*
Internal to PPC4E, RPT of maximum range	Internal Hi	HI
Internal to PPC4E, RPT with lower maximum range in PPC4E with two RPTs or a utility sensor and RPT.	Internal Lo	LO

* The display symbol is included in fields in AutoRange screens.

3.2.6 Multiple Ranges (RPTs, AutoRange and Infinite Ranging)

A PPC4E range is defined as a pressure span and associated settings.

A PPC4E may have multiple ranges. Each RPT available to the PPC4E system has a default range which is its maximum span. Additional ranges, lower than the RPT's maximum span, may be created using AutoRange (see Section 3.2.7). Ranges created using AutoRange may be saved with all their settings for reactivation later (see Section 4.7.1).

Most settings made in a PPC4E range, such as unit of measure, measurement mode, display resolution, control mode and control parameters are specific to the range. Many settings made while a range is active apply to that range and not other ranges. The range specific settings are stored with the range and recalled whenever the range is made active. This makes setting up and saving ranges a convenient way to store and recall frequently used operating configurations. See Table 5 for a listing of PPC4E adjustments and settings and whether they are range, RPT or system specific.

The ranges available on a PPC4E system may be queried (Range) and/or created (AutoRange) with functions available locally (see Section 4.7.1).

Table 5. Settings and What They Are Specific To (Range, Measurement Mode, RPT, System)

SETTING	PURPOSE	SPECIFIC TO	SECTION
Unit	Set pressure unit of measure	Range	3.2.9
Mode	Set pressure measurement mode (absolute, gauge, negative gauge)	Range	3.2.10
Resolution	Set pressure display resolution	Range	3.2.18
Jog	Set jog step size	Range	3.2.19
Control	Set pressure control mode and parameters	Range	3.2.12
Upper Limit	Set upper and lower pressure limit alarm	Range and measurement mode	3.2.20
Screen Saver, Sound, Time, ID, Level	Set system user preferences	System	3.2.24
Head	Set fluid head correction height, fluid, unit of measure	System	3.2.15
Control reference	Set EXHAUST port pressure condition	System	3.2.25.2
Purge	Enable/disable purge function	System	3.2.16
Valve Drivers	Set status of external valve drivers	System	3.2.21
TEST (-) Vent	Set status of TEST(-) vent valve, if present	System	3.2.25.6
Calibration	Various RPT and utility sensor calibration functions	RPT, utility sensor or barometer	6.2, 6.3

3.2.7 AutoRange

○ PURPOSE

To automatically set up PPC4E to optimize its measurement and control characteristics and features to cover a specific pressure range. AutoRange functions create new ranges or select from existing saved ranges.

○ PRINCIPLE

PPC4E is designed to support the calibration and test of a very wide variety of test ranges in various measurement modes with a single pressure controller system.

The AutoRange function determines which internal reference pressure transducer is used (for PPC4EX models) and simplifies the task of setting controller parameters appropriately for a specific test range. These are set automatically based on operator entry of desired measurement mode, pressure unit of measure and range full scale. The selections and default settings made by AutoRange are summarized in Table 6.

Table 6. Settings Made by AutoRange

SETTING/SELECTION	PURPOSE	SET TO	SECTION
Unit	Set pressure unit of measure	Operator specified during AutoRange	3.2.9
Mode	Set pressure measurement mode (absolute, gauge, negative gauge)	Operator specified during AutoRange	3.2.10
Full scale	Establish span maximum	Operator specified during AutoRange	None
AutoRanged span	Basis of span based setting calculations	Absolute mode: Zero absolute to full scale Gauge mode: Zero gauge to full scale Negative gauge mode: Minus atmosphere (-ATM) to full scale (negative equivalent of full scale to full scale for negative gauge ranges lower than ± ATM).	None
Reference Pressure Transducer	Selects the most appropriate reference pressure transducer to cover the requested range and mode.	Determined by PPC4E model and AutoRange span	None
Upper Limit Lower Limit	Set maximum and minimum pressure control target limits	Upper limit: 105 % of operator entered full scale pressure Lower limit: None in absolute mode, zero in gauge mode, negative atmosphere in negative gauge mode, negative equivalent of upper limit in negative gauge mode for negative gauge ranges lower than ± ATM.	3.2.20
Resolution	Set pressure display resolution	10 ppm of AutoRanged span or 1 ppm of active RPT span, whichever is larger.	3.2.18
Control Mode	Select dynamic or static pressure control	Dynamic control	3.2.2
Control Parameters	Set dynamic and static control Ready/Not Ready control limits	Dynamic control hold limit: ± 100 ppm of AutoRanged span or 10 ppm of active RPT, whichever is greater Dynamic and static control stability limit: 100 ppm of AutoRanged span or 10 ppm of active RPT span per second, whichever is greater Static control hold limit: 1 % of AutoRanged span	3.2.2 3.2.3
Jog Step	Set jog step size	100 ppm of AutoRanged span	3.2.19

Note

- AutoRanged ranges cannot have altitude units (ft, m)

○ OPERATION

See Section 4.7.1.

3.2.8 Range

○ PURPOSE

To view and/or change the active pressure measurement range and associated settings.

Note

See **AutoRange** to create ranges (see Section 3.2.7) or to select ranges (see Section 4.7.1).

○ PRINCIPLE

A PPC4E range is defined as a pressure span and associated settings (see Section 3.2.7).

A PPC4E may have multiple ranges. Each RPT available to the PPC4E system has a default range which is its maximum full scale. Additional ranges, lower than the RPT's full scale, may also be created using **AutoRange** (see Section 3.2.7). Ranges created using **AutoRange** may be saved with all their settings for reactivation (see Section 4.7.1).

Range allows the available PPC4E pressure ranges to be viewed and selected.

Note

- Range full scale limits are given in the pressure unit that is currently active for that range. Change the active unit to display the range limits in a different unit.
- Many PPC4E settings and functions are range specific. See Table 5 for identification of range specific settings.
- To protect against overpressure situations and for maximum measurement performance, the active range can only be changed when the system is vented. When prompted by the PPC4E, **VENT** causes PPC4E to vent and then complete the range change.

3.2.9 Unit

○ PURPOSE

To select the unit of pressure in which PPC4E displays pressure values.

Note

For information on selecting the measurement mode (absolute, gauge, negative gauge), see Section 3.2.10.

○ PRINCIPLE

PPC4E allows the unit of measure in which pressure values are displayed to be changed. PPC4E supports 18 predefined pressure units of measure as well as up to five user defined units. See Table 30, Section 8.2.1, for a listing of the available units of measure and the conversion factors used by PPC4E.

User defined unit definitions specify the number of user units per Pascal (Pa). 1 kiloPascal (kPa), for example, is specified by 0.001 units/Pa.

Note

- The pressure measurement unit selected is range specific. When in a given range, all functions and settings are represented in the current measurement unit for that range. However, certain internal and/or metrological functions (e.g., RPT calibration coefficients) are always represented in Pa regardless of the active range unit of measure.
- When the active unit is an altitude unit, the range and upper limit indications are in kPa if the unit is meters (m) and psi if the unit is feet (ft).
- If the pressure unit selected is a water column (inches, millimeters, meters) the reference temperature for water density must be specified.

During local operation with the graphical user interface, the temperature is included as part of the unit name, such as mmH20@4C. For remote selections the temperature is assumed to be 20 °C unless specified in the Unit remote command (see Section 5.4.4).

○ OPERATION

See Section 4.7.6.1.

3.2.10 Measurement Mode

○ PURPOSE

To set the measurement mode (absolute, gauge or negative gauge) for the active range.

○ PRINCIPLE

PPC4E supports simple, one-step switching between up to three different measurement modes:

Absolute	Measures pressure relative to vacuum (zero is hard vacuum). Range is from zero absolute to full scale.
Gauge	Measures pressure relative to atmosphere, ATM (zero is ambient pressure). Range is from zero gauge to full scale, full scale must be greater than zero.
Negative gauge	Measures pressure relative to atmosphere, ATM (zero is ambient pressure). Values are positive and negative, with ranges from negative one atmosphere (-ATM) to positive full scale. If the full scale is less than +ATM, the range is defined from the negative equivalent of positive full scale to positive full scale (for example, -10 kPa to 10 kPa gauge).

When changing measurement modes for a range, if the full scale of the range is 700 kPa (100 psi) or greater, the full scale is the same in both absolute and gauge modes. If the full scale is less than 700 kPa (100 psi), the gauge mode full scale is 100 kPa (14.5 psi) lower than the absolute mode full scale. Gauge and negative gauge mode, when available, have the same full scale.

Note

- Certain PPC4E settings are range AND measurement mode specific. See Table 5 for a listing of settings and what they are specific to.
- Absolute and negative gauge modes can be turned OFF in the calibration function (see Section 0). When absolute and negative gauge mode are turned OFF, only gauge mode can be activated.

○ OPERATION

See Section 4.7.6.2.

3.2.11 Set Pressure Automatically

○ PURPOSE

To use the automated pressure control functions of PPC4E to set and maintain target pressure values. **SET P** opens the target screen to initiate the sequence.

Note

- A target pressure entry that exceeds the current upper limit (see Section 3.2.20) or that is out of range will not be accepted as the target value.
- If PPC4E is unable to control pressure or appears to control pressure poorly, see Section 7 to troubleshoot.
- For PPC4E to set pressures under atmosphere and/or to reliably set pressures under 20 kPa (3 psi) gauge other than zero gauge, a vacuum

pump must be connected to the EXHAUST port (see Section 2.3.5) and PPC4E must be set up for control using a vacuum reference (see Section 3.2.25.2). Setting zero gauge pressure does not require a vacuum.

- The ▲ and ▼ direct pressure control keys can be used while controlling to jog the pressure control target value up or down by the jog step value (see Section 3.2.19). These keys also jog the target value when in the ENTER target value screen.
- Due to the manner in which PPC4E handles an automated pressure command for zero in absolute pressure measurement mode, a *Ready* condition can occur at a pressure well outside of the hold limit. When setting zero in absolute measurement mode, the *Ready* condition should NOT be interpreted as meaning that the pressure is zero within the hold limit. *Ready* is an indication that the rate of change of pressure inside PPC4E has reached the current stability limit. The current pressure measured by PPC4E, not zero, should be used as the value of pressure applied to the device or system under test.
- When PPC4E is given a command to set zero in absolute measurement mode, the rate of change of pressure will decrease as the pressure decreases and the rate will eventually be near zero when the vacuum pump has pulled down the pressure in the PPC4E and the test volume as far as possible. To make best use of the *Ready/Not Ready* indication when setting zero in absolute measurement mode, set the stability limit (see Section 3.2.3) to a value that represents the rate of change of pressure expected when the vacuum pump connected to the EXHAUST port has reduced pressure as far as possible.

○ OPERATION

See Section 4.5.1.

3.2.12 Control

○ PURPOSE

To set the automated pressure control mode for the active range, customize control parameters, activate default control parameters.

○ PRINCIPLE

The Control function allows the active control mode for the current range to be set to either dynamic or static. The control mode set is specific to the active range and is saved with that range when ranges are changed. For a complete description of the operation and purpose of static and dynamic control modes see Section 3.2.2.

When a control mode is selected using the Control function, Control parameters are automatically set to default values for the active range (see Table 7 for definition of PPC4E default control parameters). The default control parameters have been determined to be most suitable for the typical user to operate within PPC4E pressure control and measurement specifications. Each PPC4E default range has default control parameters and AutoRange automatically sets control parameters appropriate for the AutoRange range.

Control mode parameters can be viewed and customized in the Control function (see Section 4.7.8). Customizing the hold and/or stability control parameters changes the conditions required for a *Ready* condition to occur (see Section 3.2.3). This can be used to increase control speed (reduce time to *Ready*), usually by decreasing control precision, or to increase precision which usually decreases control speed. For example, changing the dynamic pressure control hold limit from its default value of ± 100 ppm of the active range to ± 200 ppm of the active range will decrease the time required to set a pressure since the limit within which the pressure must be set has increased. However, it will also increase the maximum possible control error when *Ready* is indicated.

Table 7. Default Pressure Control Parameters!!!

	STATIC MODE	DYNAMIC MODE
HOLD LIMIT	± 1 % of range span or 5 ppm of RPT span whichever is greater	± 100 ppm of AutoRange span or 10 ppm of active RPT span whichever is greater
STABILITY LIMIT	50 ppm of range span or 2 ppm of active RPT span, per second, whichever is greater	50 ppm of range span or 5 ppm of active RPT span, per second, whichever is greater

○ OPERATION

See Section 4.7.8.

3.2.13 Vent

○ PURPOSE

The **VENT** control key activates a sequence to bring the test pressure to atmosphere.

○ PRINCIPLE

The Vent sequence controls the pressure to near atmospheric pressure then opens the system vent valve (see Figure 18). In addition to bringing the PPC4E test pressure to atmospheric pressure, the Vent sequence also opens the RPT bypass valve for the Hi RPT on PPC4E 15K or Lo RPT on PPC4EX 100K, and after a delay, closes the control bypass valve to minimize consumption of supply gas through the control circuit (See. Figure 17) During the Vent sequence the RED Vent indication is blinking. Once the RED Vent indicator is lighted and steady and the *Ready/Not Ready* indicator becomes GREEN then the system is fully vented.

○ OPERATION

See Section 4.5.3.

3.2.14 AutoTest

○ PURPOSE

To execute a programmed sequence of automated pressure control target values.

○ PRINCIPLE

The AutoTest function is intended to facilitate the execution of a series of pressure control target values such as when PPC4E is used to run a calibration sequence on a device or system being tested.

There are three sequence choices for AutoTest:

Exercise

Cycle the Test Pressure between atmosphere or vacuum and a maximum target pressure such as when exercising a UUT prior to calibration.

The information to the right of **Exercise**: in the AutoTest menu is the last executed exercise sequence, pressure range and number of cycles.

Quick Test

Allows quick definition and execution of a sequence **in the current range and using all of the current settings** (pressure unit of measure, measurement mode, control mode, control settings, display resolution).

The information to the right of **Quick Test**: in the AutoTest menu is the step size and direction for the last executed Quick Test.

Advanced Test

AutoRanges PPC4E based on the full scale and tolerance of a device under test, prompts the user through the increments of a calibration sequence and logs calibration data. The Advanced Test function allows for the pressure at each target point to be adjusted so that the device under test reads a cardinal target pressure point. This is particularly useful when calibrating analog gauges.

The information to the right of **Advanced Test**: in the AutoTest menu is the number of saved tests available for selection.

In both the Quick Test and the Advanced Test, the PPC4E records the value of the PPC4E pressure at the time **ENTER** is used to advance to the next test point. Following the completion of the test the PPC4E values for all of the test points are displayed in a list. If the user is calibrating an analogue device, such as a gauge, the user can adjust the PPC4E pressure to set cardinal points on the analogue device before advancing to the next pressure. If this is done, the list of pressures at the conclusion of the test is the list of PPC4E pressures corresponding to the analogue cardinal points.

○ **OPERATION**

See Section 4.7.2.

3.2.15 Head

○ **PURPOSE**

To cause a pressure fluid head correction to be added or subtracted to the pressure measured by the PPC4E reference pressure transducer in order to predict the pressure at a height other than the PPC4E's reference level.

○ **PRINCIPLE**

PPC4E measures gauge or absolute pressure at the height of the rear panel **TEST(+)** port. Frequently, when performing a calibration or test, the device or system under test is at a different height than the PPC4E's **TEST(+)** port. This difference in height, frequently called **head height or head**, can cause a significant difference between the pressure measured by the PPC4E at its **TEST** port height and the pressure actually applied to the device under test which is at a different height. In this case, it is useful to make a head correction to the pressure measured by the PPC4E in order to predict the pressure actually applied at a different height.

PPC4E can calculate **head** pressures for nitrogen, helium and air as the test gas over its working pressure range. The HEAD function allows the height difference to be specified and causes the resulting head pressure to be added to the pressure measured at the **TEST** port.

The reference height of the PPC4E pressure measurement is the middle of the PPC4E TEST port. The head height should be entered as a positive value if the device or system under test is higher than the PPC4E and negative if it is lower.



Note

- **Use of the Head function to ensure in tolerance measurements is most important in low absolute pressure ranges. Specifying the head height within ± 3 in. (± 7.5 cm) is adequate to ensure that, even in the worst case, the uncertainty on the head correction will be insignificant relative to the tolerance on the measurement.**
- **The Head function is NOT range specific. The Head On or Off status remains the same as ranges are changed. Edits made to the head settings are independent of active range or RPT.**
- **The head height and fluid are shown on the graphical user interface display beside **Head**: on the Main Run Screen (see Section 4.1).**

○ OPERATION

See Section 4.7.6.3.

3.2.16 Purge

○ PURPOSE

To execute the PPC4E test system Purge function using the optional Self Purging Liquid Trap (SPLT). Purge is used to collect and exhaust liquid contaminants from the device or system under test before they reach the PPC4E.

○ PRINCIPLE

PPC4E is designed to precisely set, control and measure gas pressure. Liquid contamination of the PPC4E internal pressure control module and/or the RPT module(s) can cause poor pressure control and interfere with pressure measurement. Liquid contaminants that may be present in test devices or systems that are connected to the PPC4E **TEST(+)** port are likely to make their way back to PPC4E's internal pneumatic system as the test device or system is pressurized and depressurized by PPC4E. To every extent possible, only clean hoses and tubing should be used to connect PPC4E to test devices or systems and those devices and systems should be free of liquid contaminants. However, in the event that PPC4E must be used to test devices or systems that may contain small amounts of liquid contaminants, a Self Purging Liquid Trap (SPLT) accessory supported by the Purge function is available.

Execution of the PURGE function is automated and proceeds as follows:

- ❶ If current pressure is greater than 700 kPa (100 psi) gauge, pressure is controlled down to less than 700 kPa (100 psi) gauge.
- ❷ Pressure control stops and a 5 second wait occurs.
- ❸ SPLT exhaust valve is opened.
- ❹ PPC4E waits until pressure is less than 20 kPa (3 psi) gauge or 110 kPa (16 psi) absolute.
- ❺ PPC4E internal vent valve is opened with the SPLT exhaust valve left open.

Note

- The Purge function makes use of the PPC4E valve driver option. Valve driver number 8 is used to actuate the SPLT exhaust valve. When making use of valve drivers, note that if the Purge function is enabled, valve driver number 8 will be actuated independently of valve driver commands. See Section 3.2.21.
- For the Purge function to execute an optional Self Purging Liquid Trap (SPLT) must be installed in the test line (see Section 2.3.6.1) and the function must have been enabled. Enable with: **[Settings], <Internal>, Purge** (see Section 4.7.12.3).
- **ESC** at any time during execution of the purge routine causes the purge function to abort and returns to the Main Run Screen.
- The internal volume of the SPLT is about 20 cc. The SPLT will not operate effectively if the volume of liquid contaminants collected is greater than about 10 cc. The SPLT is designed to protect the PPC4E only against residual liquid contamination. Even if an SPLT is being used, precautions should be taken to reduce potential liquid contamination from the device or system under test as much as possible before making the connection to the PPC4E TEST(+) port.
- Do not plug the SPLT exhaust valve. The purge routine can not be completed with the SPLT exhaust valve plugged and the SPLT's protective function will not be effective.
- If the SPLT is electrically connected to the PPC4E, its exhaust valve will always be open when the PPC4E vent valve is open. If desired, it may be closed manually using the Driver function (see Section 4.7.4).

○ OPERATION

See Section 4.7.3.1.

3.2.17 Leak Test

○ PURPOSE

To run an automated leak check routine that determines the leak rate of the system connected to the PPC4E **TEST(+)** port.

○ PRINCIPLE

Leaks in the system connected to PPC4E's **TEST(+)** port can cause differences between the pressure measured by the PPC4E RPTs and pressure in other parts of the test system. A large leak can cause the PPC4E to be unable to set and control pressures reliably. The LEAK CHECK function is provided as a means of checking and quantifying the leaks that may be present in the system.

The principle of the LEAK CHECK function is the measurement of the natural decrease or increase of pressure in a fixed volume over time. The LEAK CHECK function allows a leak check time to be set. The total pressure change and the average rate of change over the leak check time are calculated and displayed.

Note

- **Changing the pressure in a test system causes adiabatic temperature changes in the gas that need to dissipate before a valid leak measurement can be made. In general, a 30 second to 1 minute wait before running a leak check is adequate to allow the adiabatic temperature change to dissipate and valid leak measurements to be made. However, stabilization time may be much longer with larger volumes, higher pressures or with liquid test media.**
- **As a general rule, the maximum acceptable leak rate for optimal PPC4E automated pressure control operation and to ensure in tolerance measurements with default pressure control parameters is 0.5 % of current range span/minute.**
- **Leak check is range specific in the sense that leak check is run using the active range. However, only one set of leak check results is maintained in memory and each leak test completed overwrites the memory. View leak check always shows the results of the last leak check run regardless of the range that is now active. The results screen includes the range indicator to indicate the range in which the leak check was run.**

○ OPERATION

See Section 4.7.3.2.

3.2.18 Resolution

○ PURPOSE

To set the resolution with which measured pressures and other pressure indications and settings are displayed.

○ PRINCIPLE

The resolution with which PPC4E displays pressure values can be adjusted. This feature can be used to reduce the resolution when lower precision measurements are being made and excess resolution might confuse or distract the operator.

The resolution setting determines the number of digits with which pressure is displayed. The resolution is calculated based on the full scale of the range and then rounded to the furthest digit to the right. For example, resolution of 0.001 % on a range of 150 kPa is $150 \times 0.001 \% = 0.0015$ which is rounded down to 0.001 kPa.

Note

- Default resolution is 10 ppm of active range span. Resolution is set automatically by AutoRange (see Section 3.2.7).
- The resolution setting is range specific. A resolution setting made in one range does NOT affect other ranges.
- The measured pressure resolution is fixed for altitude units at 1 m in meters and 1 ft in feet.
- The maximum resolution setting is limited in AutoRange ranges that are less than 10% of the active RPT default full scale.

○ OPERATION

See Section 4.7.6.4.

3.2.19 Jog

○ PURPOSE

Adjust the nominal change in pressure caused by using the jog direct pressure control keys (▲ and ▼) or the front panel knob when available.

○ PRINCIPLE

The jog direct pressure control keys, ▲ and ▼, increase or decrease pressure by a nominal amount each time they are pressed. If pressure control is NOT active, pressing the jog key causes an up or down slow pressure ramp. If pressure control is active, the jog key causes the pressure control target value to be changed by the amount of the jog step.

“Knob jog” is available by menu selection when dynamic control is active or during Auto Test (see Sections 3.2.2.1 and 3.2.14). **knob jog** opens a screen in which rotating the knob one “click” to the right increases the control target by the jog step and rotating the knob one “click” to the left decreases the control target by the jog step.

Note

- The default jog step is 100 ppm of active range span. The maximum jog step is 5% of active range span. Jog step value is set automatically by AutoRange (See Section 3.2.7).
- The jog step setting is range specific. A jog step setting made in one range does NOT affect other ranges.

○ OPERATION

See Section 4.7.8.2.1.

3.2.20 Pressure Limits

○ PURPOSE

To set the upper and lower limit pressure value for a pressure range and measurement mode.

○ PRINCIPLE

The Upper Limit function allows the setting of a maximum pressure not to be exceeded when using a specific range and measurement mode. Absolute and gauge measurement modes (see Section 3.2.10) have their own, specific limits. Negative gauge mode also has a lower limit.

Automated pressure control targets greater than the upper limit or lower than the lower limit are not accepted. When the pressure measured by PPC4E exceeds the upper limit or lower limit, automated or direct manual pressure control is aborted and an intermittent warning beep sounds.

The Upper Limit most often protects the device or system connected to the PPC4E **TEST(+)** port from accidental overpressure.

Note

The default upper limit is 105 % of AutoRanged span or 102 % of active RPT default (maximum) range, whichever is lower. In negative gauge mode, the default lower limit is -ATM or the negative equivalent of the upper limit, which ever is higher (less negative).

⚠ Caution

Upper limit values are specific to each range and measurement mode. Be careful not to assume that the upper limit set in one measurement mode will apply to the other.

For example, if 150 kPa is selected as the upper limit in gauge mode, the upper limit will typically not be 150 kPa in negative gauge mode of the same range.

○ OPERATION

See Section 4.7.8.1.

3.2.20.1 Over Pressure Function

In addition to the UL function, PPC4E has an over pressure function.

The over pressure function executes when an RPT measures a pressure that is 104 % of its default span. PPCE 15K and PPC4EX 100K also have a negative over pressure limit of -17.5 kPa (- 2.3 psi) when the differential RPT is active. The differential pressure RPT is the Hi RPT on PPCE 15K or the Lo RPT on PPC4EX 100K.

The over pressure function causes all pressure control to be interrupted and disabled, changes the active range to the default range of the Hi RPT and causes the measured pressure display to flash. If the active RPT is differential, the **TEST(+)/TEST(-)** bypass valve is opened. The overpressure function also logs the time and date of the overpressure condition in both user and factory logs to assist in incident diagnosis (see Section 3.2.25.5).

To recover from an overpressure condition, correct the overpressure condition and cycle PPC4E power. Be sure to correct the condition that caused the overpressure before cycling power.

3.2.21 Drivers

○ PURPOSE

To control the output signals of PPC4E's 8 channel, 12 V external drivers.

○ PRINCIPLE

PPC4E external drivers are available to drive peripheral equipment in a PPC4E system, for example, solenoid valves or the optional Self Purging Liquid Trap (SPLT). The driver electrical connections are available from a rear panel connector

⚠ Caution

The PPC4E PURGE function makes use of the valve driver option. Valve driver number 8 is used to actuate the SPLT exhaust valve. The SPLT exhaust valve is actuated when performing the Purge function and in the background every time the PPC4E VENT function is used. When making use of valve drivers, note that when the Purge function is enabled, valve driver number 8 will be actuated independently of user initiated valve driver commands (see Section 3.2.16).

○ OPERATION

See Section 4.7.4.

3.2.22 Remote

○ PURPOSE

To configure the PPC4E COM1, COM2 or IEEE-488 (GPIB) communication ports. To test COM1 and COM2 communications. To select remote programming communications format. COM1, COM2 and IEEE-488 (GPIB) ports are standard on all PPC4E controllers.

○ PRINCIPLE

The PPC4E has two RS232 communications ports referred to as COM1 and COM2 and an IEEE-488 (GPIB) port. COM1 or IEEE-488 are for communicating with a host computer (see Section 5.2). COM2 is reserved for communicating with an external device (i.e. RPM4, multimeter, etc.). Port settings can be viewed and changed using front panel commands. The USB port is only used for updating firmware (see Section 6.5).

The PPC4E has 3 different syntax formats available for remote program commands. **Classic** format is compatible with previous PPC products and is the default format. **Enhanced** format follows the syntax, format, and status reporting features of IEEE Std 488.2.

○ OPERATION

See Section 4.7.9.

3.2.23 Reset

○ PURPOSE

To reset various PPC4E settings to default or factory values.

○ PRINCIPLE

PPC4E stores its user definable settings in non-volatile memory. The reset menu allows the user to selectively or completely reset these settings to factory defaults. This clears out any settings that the user has made, and should be used only to restore the PPC4E to a known state. PPC4E goes through its power up sequence after any type of reset is executed.

Caution

PPC4E reset functions will change current settings to factory defaults. These may include settings vital to PPC4E operation and affecting the calibration of the reference pressure transducers (RPTs). Reset functions should only be used by qualified personnel with knowledge of reset consequences. Reset functions should not be used experimentally.

Reset menu choices include:

Settings	to reset general system operating parameters (see Section 3.2.23.1).
Units	to reset unit of measure functions (see Section 3.2.23.2).
AutoTest	to reset AutoTest parameters and clear the AutoTest data log (see Section 3.2.23.3).
Calibration	to reset internal calibration coefficients and modes (see Section 3.2.23.4).
All	to reset all settings except ID and security password to factory default values (see Section 3.2.23.5).

3.2.23.1 Settings

○ PURPOSE

Sets most general operating parameters back to default values. Does not affect calibration coefficients, remote interfaces or AutoRange ranges. Reset Settings resets are itemized in Table 8.

Table 8. Reset Settings

RESET	RESULT	SEE SECTION
Unit	Returns pressure unit of measure to first of six available.	3.2.9
Mode	Returns measurement mode to the natural RPT mode.	3.2.10
AutoRange	Hi RPT default range.	3.2.7
Head	0 cm height and Nitrogen medium.	3.2.15
Control Mode	Dynamic	3.2.2
Control Limits	Default values of Hi RPT default range.	3.2.12
Upper Limit	Value of Hi RPT default range.	3.2.20
Resolution	0.001% FS of Hi RPT default range.	3.2.18
Purge	Disable purge function.	3.2.16
Control Reference	Auto.	3.2.25.2
Leak Check	15 second run time	3.2.17
Screen Saver	1 hour to activation	3.2.24.1
Key Sounds	Medium	3.2.24.2
TEST (-) Vent	Automatic.	3.2.25.6
Control Configuration	Return to default control coefficients.	6.4

○ OPERATION

See Section 4.7.5.2.1.

3.2.23.2 Units

○ PURPOSE

Resets Unit selections to factory defaults and clears the Favorites list.

Sets the user defined unit(s) to default names and 1.000/Pa (see Section 4.7.6.1.3).

○ OPERATION

See Section 4.7.5.2.2.

3.2.23.3 AutoTest

○ PURPOSE

Resets Exercise, Quick Test and Advanced Test to default characteristics (see Section 3.2.14).

○ OPERATION

See Section 4.7.5.2.3.

3.2.23.4 Calibration

○ PURPOSE

⚠ Caution

The Reset Calibration function will reset RPT and barometer calibration coefficients and settings. This will change the PPC4E calibration and could cause it to make out of tolerance measurements.

Clears all user values affecting the calibration of RPTs, utility sensor and the on-board barometer. Does not clear factory coefficients. Reset Calibration resets are itemized in Table 9.

Table 9. Reset Calibration

RESET	RESULT	SEE SECTION
All RPT user calibration coefficients	PA to zero, PM to 1.	6.2.1.1, 6.2.7
Absolute and negative gauge mode	ON.	6.2.5
On-board barometer calibration coefficients	PA to zero, PM to 1.	6.3
Calibration date	Set all dates to 19800101.	6.2.7, 6.3
P _{offset}	Absolute P _{offset} value to zero.	6.2.7

○ OPERATION

See Section 4.7.5.2.4.

3.2.23.5 All

○ PURPOSE

⚠ Caution

The Reset - All function clears and deletes large amounts of user defined information including critical calibration data.

Combines all resets in one global reset command that clears the entire user section of non-volatile memory returning PPC4E to the “as delivered” condition except the ID function (see Section 3.2.25.1) and the security level password (see Section 3.2.24.4). Reset All resets are itemized in Table 10.

Table 10. Reset All

RESET	RESULT	SEE SECTION
Reset – Sets	All the resets of Reset – Sets	3.2.23.1
Reset – Units	All the resets of Reset – Units	3.2.23.2
Reset – AutoTest	All the resets of Reset - AutoTest	3.2.23.3
Reset – Calibration	All the resets of Reset - Calibration	3.2.23.4
Remote Interfaces	COM1, COM2 and IEEE-488.2 interfaces to default settings.	3.2.22
Remote Communications	Remote command format to Classic.	3.2.22
Security (Level)	Low	3.2.24.4

○ OPERATION

See Section 4.7.5.2.5.

3.2.24 Preferences

○ PURPOSE

To access a menu of PPC4E operational preferences and functions.

3.2.24.1 Screen Saver

○ PURPOSE

To adjust the PPC4E's Screen Saver settings.

○ PRINCIPLE

PPC4E has a Screen Saver function which causes the display to go into a screen saving mode after receiving no front panel input for a certain amount of time. The screen saving default time is 1 hour. The screen saver activation time can be adjusted by the user or screen saving can be completely eliminated.

Note

Setting screen saver time to off eliminates the Screen Saver function so that the display permanently remains on and at full brightness.

○ OPERATION

See Section 4.7.7.1.

3.2.24.2 Sounds

○ PURPOSE

To adjust or suppress the PPC4E key press sounds.

○ PRINCIPLE

PPC4E is equipped to provide audible feedback and alarms. The sounds are used for the following indications:

Valid key press	Brief beep. Choice between three frequencies or NO sound is available (4.7.7.2).
Invalid key press	Descending two tone "blurp".
Leak check completed	Three two second beeps (see Section 3.2.17).
Upper or lower limit exceeded	Intermittent one second beeps (see Section 3.2.20)
Pmax! (overpressure limit) exceeded	Eight second high frequency beep (see Section 3.2.20.1).

○ OPERATION

See Section 4.7.7.2.

3.2.24.3 Time

○ PURPOSE

To view and edit the PPC4E internal time and date settings.

Note

- The PPC4E date and time are set to United States Mountain Standard Time in the final test and inspection process at the factory. If desired, use the TIME and DATE functions to set your local time and date.
- The PPC4E has an internal real time clock that is used for date and time stamping calibrations and internal logs.

○ OPERATION

See Section 4.7.7.3.

3.2.24.4 Language

○ PURPOSE

To specify the language for PPC4E display, headings, menus and screens.

Note

- The language selection affects to headings, field names and on-screen messages. Numeric displays, including pressure units, buttons and Fluke trademarked terms, such as AutoRange, are always in English.
- Remote commands and their responses are always in English, regardless of language setting.

○ OPERATION

See Section 4.7.7.4.

3.2.24.5 Security

○ PURPOSE

To set user protection levels to restrict access to certain functions and to edit the password required for changing user levels.

○ PRINCIPLE

PPC4E's front panel user interface provides the means to access all PPC4E user defined data, settings and functions including calibration data. Inadvertent, uninformed or unauthorized altering or deleting of data, settings and functions could require extensive reconfiguration by the user and might cause invalid readings and behavior. For these reasons, depending upon the application in which PPC4E is being used, it may be desirable to restrict access to certain functions for certain users. The user level function provides a means of restricting access to certain functions. Four different levels of security are available.

Access to changing security levels can be left open, or be protected by a password.

Security Levels

The security levels are structured to support typical operating environments as follows:

- | | |
|-------------|---|
| Off | This level is intended for use only by the system manager and/or calibration facility. It allows access and editing in all areas including critical metrological information. |
| Low | Low security is designed to protect the specific metrological information and SYSTEM DIAGNOSTIC AND MAINTENANCE functions of the system against accidental alteration. It is intended for an advanced operator performing many different tasks. Low security is the default user level setting. |
| High | High security is designed to protect all operating parameters. It is intended to minimize operator choices, for example to perform repeated identical calibrations under consistent conditions. |

⚠ Caution

PPC4E is delivered with the security level set at low to avoid inadvertent altering of critical internal settings but with access to changing security levels unrestricted. It is recommended that the low security level be maintained at all times during normal operation. If there is a risk of unauthorized changing of the security level, changing authority should be password protected.

The security levels are structured to support typical levels of operation as shown in Table 11. Security levels prevent execution of the functions accessed by the key strokes marked by “•” or, in some cases, prevent changes from being saved – thus allowing viewing of settings without allowing changes to be made:

Table 11. Security Levels, Advanced Interface

FUNCTION	LOW	HIGH
[AutoRange], [Delete Range]		•
[AutoRange], [Save Range]		•
[Settings], <Internal>, Event Log, [Clear Log]	•	•
[Settings], <Preferences>, Screen Saver		•
[Settings], <Preferences>, Sounds		•
[Settings], <Preferences>, Time		•
[Settings], <Pressure>, Pressure Unit, [Reset		•
[Settings], <Pressure>, Pressure Unit, <User Units>		•
[Settings], <Remote>		•
[Settings], Calibration, [Barometer]	•	•
[Settings], Calibration, [Hi RPT]	•	•
[Settings], Calibration, [Lo RPT]	•	•
[Tools], <Autotest>, Advanced Test, [Delete]		•
[Tools], <Autotest>, Advanced Test, [Edit]		•
[Tools], <Autotest>, Advanced Test, [New]		•
[Tools], <System>, Control Configuration		•
[Tools], <System>, Resets		•

“•” indicates changes in the function/ menu are NOT allowable.

○ OPERATION

See Section 4.7.7.5.

3.2.25 Internal Functions

○ PURPOSE

To view, set, adjust, and maintain various aspects of PPC4E's internal operation.

3.2.25.1 Identification

○ PURPOSE

To view or edit the PPC4E user ID and to view the PPC4E serial number.

Note

The ID can be set remotely from a computer which is more convenient than entering characters from the keyboard (see Section 5.4.4, ID command). The ID is not cleared or reset by any RESET function (see Section 3.2.23).

○ OPERATION

See Section 4.7.12.1.

3.2.25.2 Control Reference

○ PURPOSE

To specify whether PPC4E should automatically determine whether a vacuum source or atmospheric pressure is connected to its **EXHAUST** port or to manually set the **EXHAUST** port condition.

○ PRINCIPLE

The PPC4E exhaust (down) control valves and the output of the exhaust pressure regulator are connected to the PPC4E **EXHAUST** port (see Figure 17).

The response of the pressure control module, particularly when controlling pressure near and under atmospheric pressure, changes depending on whether the **EXHAUST** port is connected to a vacuum source or left open to atmosphere. To use the proper pressure control algorithms, PPC4E must know the condition of the **EXHAUST** port.

The Control Reference function allows the PPC4E to know whether its **EXHAUST** port is at vacuum or atmospheric pressure. An independent exhaust pressure sensor measures the pressure present at the port. Normally, the exhaust sensor output is used automatically by PPC4E to determine the **EXHAUST** port condition. If desired, this automatic determination can be overridden and the **EXHAUST** port condition set manually.

The Control Reference function allows setting of whether the **EXHAUST** port condition will be determined automatically using the exhaust sensor or set manually. It also allows viewing of the current status of the **EXHAUST** port.

Note

- The normal Control Reference setting is **Auto**. With this setting, the operator need not be concerned with informing the PPC4E of **EXHAUST** port pressure conditions as PPC4E determines the existing condition automatically. The other settings are normally used only for special applications or trouble shooting. Pressure control near and under atmospheric pressure will not operate properly if the Control Reference is not set correctly.
- The Control Reference setting is not range or control mode specific.
- The setting made in Control Reference is common across RPTs and ranges as they are changed.

Caution

Before connecting a vacuum pump or vacuum source to the PPC4E **EXHAUST** port, see Section 2.3.5 for information on vacuum connection requirements and precautions.

○ OPERATION

See Section 4.7.12.2.

3.2.25.3 Barometer

○ PURPOSE

To view the value of atmospheric pressure as measured by the PPC4E on-board barometer.

○ PRINCIPLE

PPC4Es with an on-board barometer to measurement atmospheric pressure for dynamic compensation of atmospheric pressure (see Section 3.2.4 and 3.2.10) and for static pressure compensation when a differential RPT is active.

Note

- See Figure 17 for schematics showing the position of the on-board barometer in PPC4E's measurement system.
- The on-board barometer is a low accuracy sensor used only for measuring small changes in atmospheric pressure over short periods of time (see Section 3.2.4) and for line pressure compensation when using a differential RPT. PPC4E measurement uncertainty does not depend on the measurement uncertainty of the on-board barometer.

3.2.25.4 Purge

○ **PURPOSE**

To enable and disable the PURGE function which automate use of the optional Self Purging Liquid Trap (SPLT) (see Section 3.2.16).

⚠ Caution

When the purge function is enabled, PPC4E makes background use of valve driver channel #8 independently of user actions (see Sections 3.2.16, 3.2.21).

3.2.25.5 Log

○ **PURPOSE**

To view and/or clear the PPC4E event log.

○ **PRINCIPLE**

PPC4E records to a log each time one of the following events occurs:

- Pmax! of an internal PPC4E RPT or utility sensor is exceeded (see Section 3.2.20.1).
- A memory fault occurs.

Note

It is possible for PPC4E to be overpressured without logging the event. The most likely situations for an overpressure event that is not logged is when the unit is powered off, or when the pressure is changed too rapidly for the RPT to log the overpressure before damage occurs.

○ **OPERATION**

See Section 4.7.12.4.

3.2.25.6 TEST (-) Vent

○ **PURPOSE**

For models PPC4EX 100K and PPC4E 15K, causes the PPC4E BG15K RPT TEST (-) vent valve to stay open or closed rather than open and close automatically.

Note

This feature is active only when the active RPT is BG15K (Hi RPT on PPCE 15K or Lo RPT on PPC4EX 100K).

○ PRINCIPLE

A PPC4E equipped with a BG15K RPT has a TEST (-) vent valve in its RPT module (see Figure 13).

The TEST (-) vent valve connects the **TEST (-)** port to the **VENT** port which also connects the RPT and the device or system under test low side to atmosphere. In normal PPC4E operation, the TEST (-) valve is closed automatically whenever the PPC4E is performing fine pressure control to isolate the TEST (-) circuit from fluctuations in ambient pressure. The valve is opened at all other times. This ensures that the pressure in the TEST (-) circuit does not move too far away from atmospheric pressure as it might if it were permanently shut off.

The function allows the TEST (-) vent valve to be set to be permanently open, permanently closed or to operate in its default automated condition. It also allows the current status of the valve to be viewed.

Note

The normal setting for the TEST (-) vent valve is Auto in which PPC4E automatically controls the valve based on current PPC4E operation. Manual settings should only be selected by advanced users.

⚠ Caution

If the PPC4E detects a condition in which it determines there could be a risk of overpressure to the RPT by opening the TEST (-) Vent valve when a Manual Open is requested, a message indicating a DP overpressure risk is displayed. If this message is displayed, return to normal operation, vent the PPC4E and try again.

○ OPERATION

See Section 4.7.12.5.

3.2.26 Calibration

○ PURPOSE

To calibrate the PPC4E Hi and/or Lo RPTs and adjust the on-board barometer. This function is considered part of PPC4E maintenance and is therefore covered in the maintenance section of this manual (see Sections 6.2 and 6.3).

○ OPERATION

See Sections 6.2 and 6.3.

3.2.27 Measurement Uncertainty

○ PURPOSE

PPC4E has the ability to configure, calculate and display the uncertainty in pressure for each controlled pressure target. The uncertainty value is available locally with the Advanced Interface and is also available remotely in the response to the PRR command for all PPC4E models (see Section 5.4.4, PRR Command). Uncertainty can be defined with or without control components (delivered or measured pressure uncertainty). Uncertainty components are explained below and default values are given in Table 2.

○ PRINCIPLE

The following uncertainty components can be configured for pressure uncertainty calculation, displayed when the PPC4E is *Ready*.

3.2.27.1 Product Uncertainty

Product uncertainty is a combination of reference, repeatability, linearity, hysteresis, slope stability, temperature and line pressure uncertainties. All of

these components are considered together in the Span uncertainty (see Section 3.2.27.2). In gauge mode the span uncertainty represents the product uncertainty. In absolute mode there is an additional component associated with zero stability (see Section 3.2.27.4).

3.2.27.2 Span

The span uncertainty represents the uncertainty associated with the active AutoRange span. Span uncertainty decreases with AutoRanged span down to the scaling factor. For PPC4E the default Scaling Factor is 10% of controller span for PPC4E and 1% for PPC4EX pressure controllers. This means that the 0.02% of AutoRanged span applies for all AutoRanges down to 1% of the controller span for PPC4EX models and down to 10% for PPC4E models. The default value for span uncertainty is 0.02% for all models in all operating modes.

3.2.27.3 Head

Head specifies the uncertainty of head height and is specified in the active height unit (cm or in). The value is converted to pressure uncertainty with standard gravity and the calculated density of the fluid at measured pressure. The default value of the head uncertainty is 0.

3.2.27.4 Zero Stability (Constant)

Zero stability is an uncertainty based on the zero stability of the RPT. There is a default constant that is associated with zero stability in absolute mode only (see Table 2). This value is not used in gauge and negative gauge modes.

3.2.27.5 Control Uncertainty

When delivered pressure uncertainty is desired an additional uncertainty can be added to the measured pressure uncertainty. The control uncertainty calculations are based on the active control parameters (see Section 3.2.2) so it is not necessary to enter additional values.

3.2.27.5.1 Dynamic Control

The control uncertainty during dynamic control when the PPC4E is *Ready* is equal to the hold limit (see Section 3.2.2). Dynamic control uncertainty assumes that the measured pressure is equal to the target pressure with an uncertainty equal to the control hold limit.

3.2.27.5.2 Static Control

The control uncertainty during static control is defined by the stability setting and the read rate of the PPC4. Typically, the control uncertainty in static mode is negligible unless the stability limit is set abnormally high.

Note

In dynamic mode, the pressure value returned from the PR and PRR commands (see Section 5.4.4, PR and PRR Commands) is the measured pressure, not the target pressure. The control uncertainty is based on the target pressure and may be considered conservative when applied to the measured pressure. The value of control uncertainty may be considered pertinent, however, since the measured pressure can vary within the hold limit while *Ready*.

3.2.27.6 Combining uncertainties

3.2.27.6.1 Measured Pressure Uncertainty

Measured pressure uncertainty is the combination of the product uncertainty and the uncertainties in pressure head and zero stability.

$$U_{meas} = 2 \times \sqrt{\left(\frac{U_{span}}{2}\right)^2 + \left(\frac{U_{head} \times \rho_{gas} \times g_{std}}{2}\right)^2 + \left(\frac{U_{const}}{\sqrt{3}}\right)^2}$$

where:

U_{meas} : Measured pressure uncertainty.

U_{span} : Product uncertainty in % of AutoRanged span.

U_{head} : Uncertainty of head height measurement in cm or inches.

ρ_{gas} : Density of the test gas. In gauge mode replaced with $(\rho_{gas} - \rho_{air})$, where ρ_{air} is standard air density, 1.2 kg/m³.

g_{std} : Standard gravity 9.80665 m/s².

U_{const} : Uncertainty associated with zero drift of the RPT in absolute mode.

Note

$\sqrt{3}$ is the denominator of Constant uncertainty for the proper reduction to k=1 for a rectangular distribution assigned to stability uncertainties.

3.2.27.7 Delivered Pressure Uncertainty

Delivered pressure uncertainty is measured uncertainty defined in Section 3.2.1.2.1 combined with control settings. If in dynamic control mode the additional uncertainty that is combined is equal to the hold limit. When in static control mode the uncertainty is the current pressure stability in pressure units per second multiplied by the update rate of the PPC4.

$$U_{del} = 2 \times \sqrt{\left(\frac{U_{meas}}{2}\right)^2 + \left[\left(\frac{HL}{\sqrt{3}}\right)^2 \text{ or } \left(\frac{P_{Stab} \times UpdateRate}{\sqrt{12}}\right)^2\right]}$$

where:

U_{del} : Delivered pressure uncertainty.

HL : Dynamic mode hold limit.

P_{Stab} : Current pressure stability.

$UpdateRate$: Fixed value in seconds.

Note

The denominator of the dynamic mode uncertainty component is divided by the $\sqrt{3}$ because it is considered to be a rectangular distribution. The denominator for the static control uncertainty component is divided by the $\sqrt{12}$ because it also is a rectangular distribution but represents a full width interval.

3.2.27.8 Using Values Other Than Default

The default values of the uncertainty components represent typical pressure measurement uncertainty specifications (see Section 1.2.2.1). These values are based on all RPT based product lines with a confidence of 95%. This means that, taken individually, there is a good chance that the uncertainty of a given Q-PRT is lower than default. All values represented in Table 2. PPC4E Measurement Uncertainty (Includes Precision) can be modified in the product.

○ OPERATION

See Section 6.2.7.1.

4. Operation

4.1 Main Run Screen

The PPC4E Main Run Screen is the home display for the graphical user interface. It is displayed on power-up and is the screen from which all other functions and menus are accessed. It is the top level of the menu structure.

The Main Run Screen is where the operator works with PPC4E to set and read pressures. It provides complete information on the system's current configuration and operating status.

Figure 7 shows the PPC4E Main Run Screen display fields and selectable fields. Table 12 lists the contents and purpose of these fields as well as references to manual sections for more detailed information and explanation.

Note

PPC4E has a screen saver function that is enabled after a period of inactivity. Pressing any key or rotating the knob restores the display. The screen saver display can be selected, the time delay can be changed or screen saving can be suppressed (see Section 4.7.7.1).

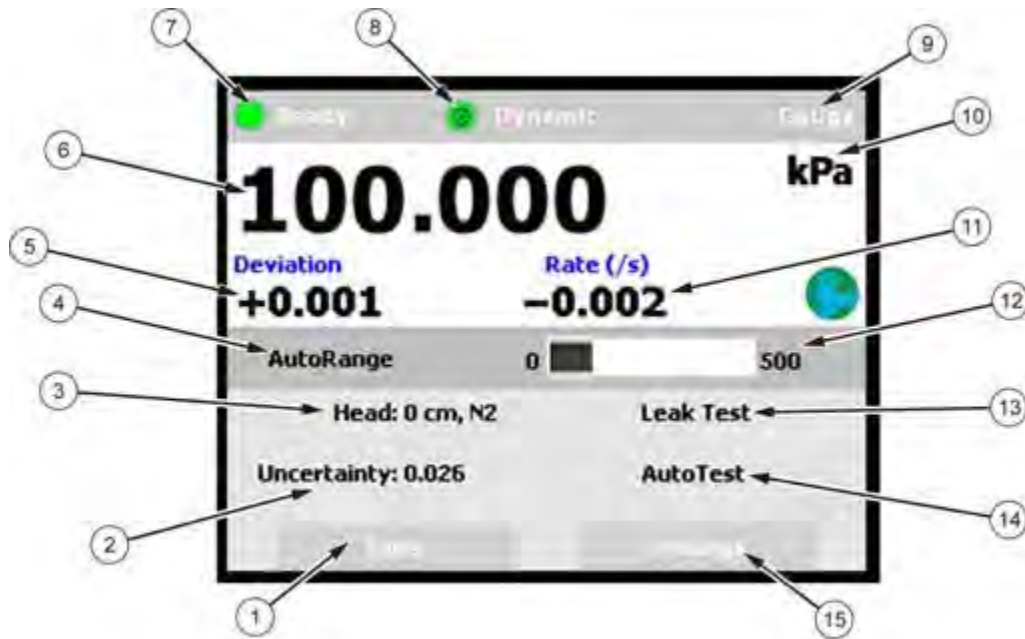

Figure 7. Main Run Screen Display and Selectable Fields (see Table 12)

Table 12. Main Run Screen Fields and Buttons

FIELD	DESCRIPTION	PURPOSE	CONTENTS	SECTION
①	[Tools] button	Access PPC4E Tools functions		none
②	Uncertainty	Shortcut to the Uncertainty settings screen	Measured pressure uncertainty value	6.2.7.1
③	Head	Shortcut to the Head settings screen	Current pressure head value, fluid	4.7.6.3
④	[AutoRange] button	Enter the AutoRange screen		4.7.1
⑤	Target Pressure Pressure Information	Enter to set target pressure. Display pressure information depending on PPC4E function. Label above defines contents.	Numeric value and sign Label: Target (control target pressure) or Deviation (deviation from target value)	4.5.1
⑥	Measured Pressure	Display pressure measured by active RPT Shortcut to Resolution Screen	Numerical pressure value and sign	4.7.6.4
⑦	Ready/Not Ready indicator	Indicate pressure <i>Ready/Not Ready</i>	<Green>: <i>Ready</i> <Yellow>: <i>Near Ready</i> <Red>: <i>Not Ready</i>	3.2.3
⑧	Control Mode Control Status Indicator	Indicate current control mode and control status Shortcut to control settings screen	Control mode: Static or Dynamic Indicator solid : not controlling Indicator animated : controlling	4.7.8.2
⑨	Measurement Mode	Identifies measurement mode of displayed pressure Shortcut to measurement mode screen	Absolute Gauge Negative Gauge	4.7.6.2
⑩	Unit of Measure	Identifies pressure unit of measure in which measured pressure and pressure information values are displayed Shortcut to unit of measure screen	Pressure unit of measure abbreviation	4.7.6.1
⑪	Pressure Rate of Change	Display rate of change of pressure in current units per second	Numerical value and sign in current pressure units/s	none
⑫	AutoRange Range Indicator	Display AutoRange limits	Lower and upper limits of AutoRanged range with bar graph of measured pressure	3.2.6 4.7.1
⑬	Leak Test	Shortcut to leak test screen		4.7.3.2
⑭	AutoTest	Shortcut to Advanced AutoTest		4.7.2
⑮	[Settings] button	Enter the PPC4E Settings menu		none

* Noted fields have pressure values expressed in current pressure units.

4.2 Other Screens

All lower level screens (screens other than the Main Run Screen) have similar formats. The screen in Figure 8 shows one possible lower level screen shown by selecting [Settings], <Pressure>. Numbered displays and selectable fields are described in Table 13.

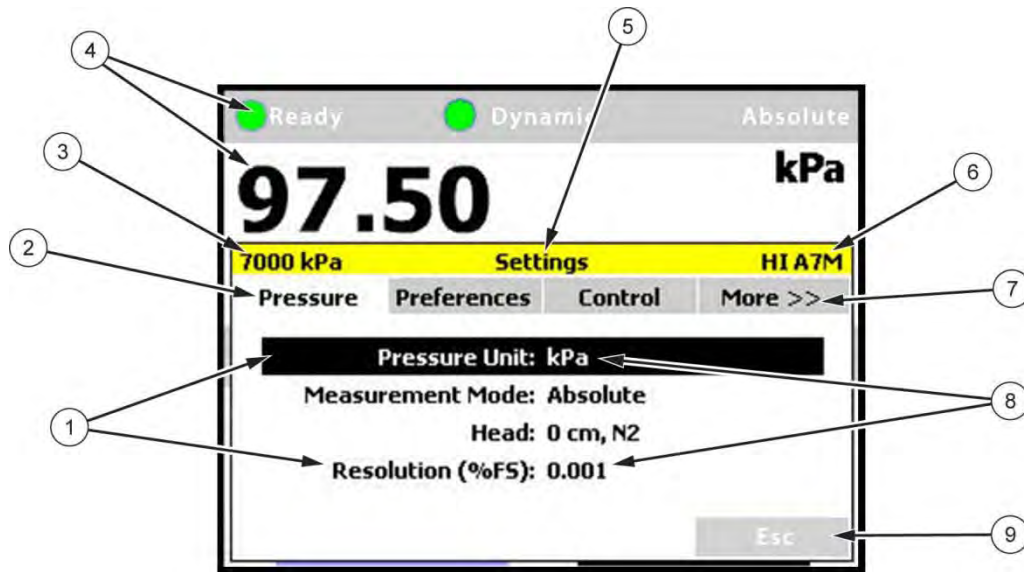

Figure 8. Lower Level Screen Example (see Table 13)

Table 13. Lower Level Screen Displays and Selectable Fields

FIELD	DESCRIPTION	CONTENTS
①	Selectable fields	Display list of fields available for selection and editing in currently active tab <Pressure>
②	Tabs <Pressure>, <Preferences>, <Control> and <More >>>	Available tabs for selection. Each tab contains selectable or editable fields.
③	Current AutoRange Range	Value of range in currently active unit of measure
④	Current Pressure, Ready Status and Control Indicator	Ready Indicator, Control Indicator, Measurement Mode, Pressure and Unit of Measure
⑤	Screen Heading	Heading of currently active screen
⑥	Active RPT and Location	HI Hi RPT LO Lo RPT
⑦	<More >>> tab	Show more tabs available for selection
⑧	Current values	Some editable fields display current values on the selection screen for convenience so the user can see them without having to select the field and change screens to do so.
⑨	[Esc] button	Returns to Main Run Screen

4.3 Keypad Layout and Protocol

The PPC4E has a keypad and navigation knob for local operator access to on screen menus and for data entry in addition to direct pressure control keys.

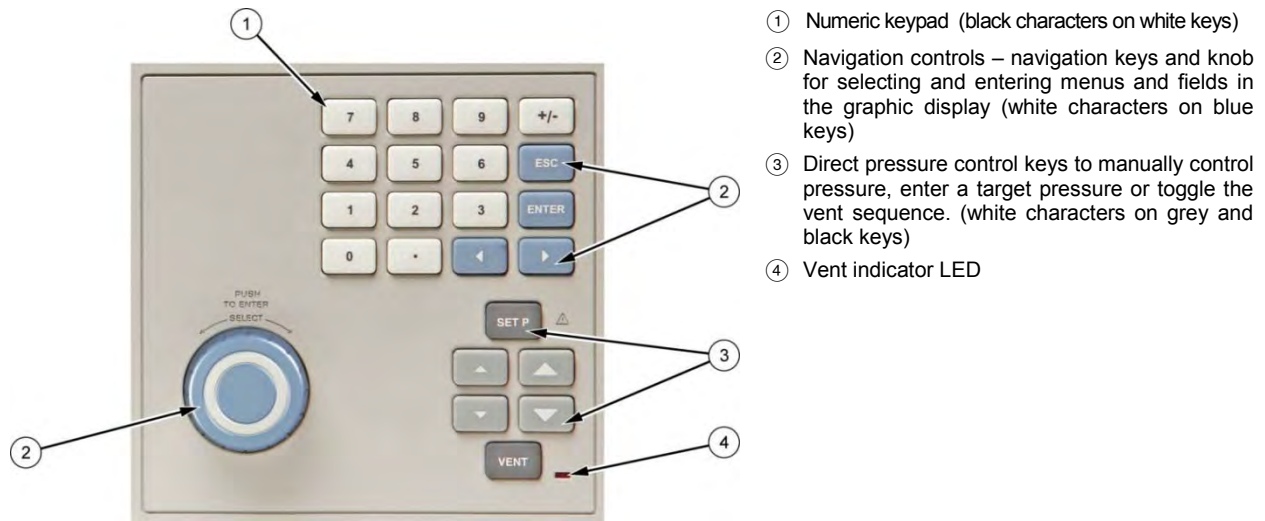

Figure 9. Keypad layout

4.4 Conventions for the Graphical Interface

4.4.1 Navigation Controls and Keypad

Menu navigation and selection with the graphical display is described in the text as follows:

- **[xxx]** indicates buttons, (i.e. **[Tools]**)
- **<xxx>** indicates tabs (i.e. **<Control>**)
- **xxx** indicates other fields (i.e. **Unit**)

Buttons, tabs and fields used in sequence are shown on one line, separated by commas, for example:

[Settings], <Pressure>, Unit

Front panel keys are shown as individual keys, (i.e. **ENTER**)

Note

For dedicated front panel keys, such as **ESC**, **VENT**, **SET P**, and **ENTER**, any time a key is shown in the manual, it should be interpreted to mean “press this key”. For example: **ESC** to return to the Main Run Screen means “Press the **ESC** button to return to the Main Run Screen”.

The numeric keypad is used for data entry and editing. Pressing **+/-** changes the numerical sign when editing.

4.4.2 Navigating Menus

Note

Throughout the Operation section of the manual the following terms are used, when presented with initial capitals and in italics, these words have the following meanings:

- Select* Move the cursor or screen focus between fields by rotating the knob. Can also use the cursor control keys (**◀** and **▶**) to move the cursor.
- Enter* Push the knob on a Selected field. Can also use **ENTER**.

The graphical user interface is a “point and click” style interface, much like navigating on a computer screen. Simply *Select* a button, tab or field on the screen and then *Enter* to move forward in the menu selection. To edit a field either *Select* the field and *Enter* or start editing the value with the keypad. *Enter* to accept an entry.

ESC typically returns to the Main Run Screen from other screens or causes execution to cease or suspend if an automated process or sequence is in operation. **ESC** from the Main Run Screen allows momentary viewing of the PPC4E model information screen.

Examples of typical screens and descriptions of how to navigate in them are shown in the following examples.



Example 1: Selecting an Individual Field from a Tabbed Form.

[Settings], **<Pressure>**, **Pressure Unit**

Enter **[Settings]** to open the Settings tab screen. From here scroll between tabs **<Pressure>**, **<Preferences>**, **<Control>** and **<More >>>**.

Entering the **<Pressure>** tab from the Settings screen enters the Pressure settings screen, shown. From here select and *Enter* a field in the **<Pressure>** tab.

[Esc] or **ESC** to return to the Main Run Screen.

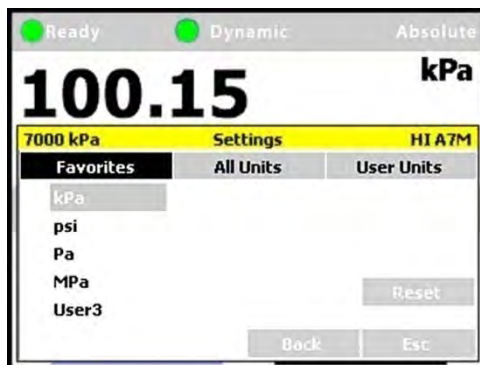

Example 2: Continuing from Example 1 to select a unit of “psi” from a List.

[Settings], **<Pressure>**, **Pressure Unit**, **<Favorites>** **psi**

Enter the **Pressure Unit** field from the **<Pressure>** tab to display the Pressure Unit screen. Scroll between tabs **<Favorites>**, **<All units>** or **<User units>**.

Enter **<Favorites>** to allow selecting one of the five most recently used units and entering a new unit, for example “psi”. The currently active selection is shown in gray.

[Back] to go back one menu level to the Settings screen.

[Esc] or **ESC** to return to the Main Run Screen without making a new selection.

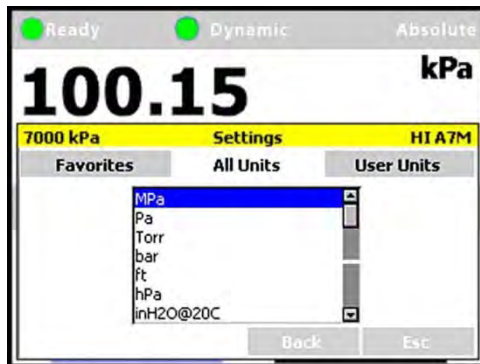

Example 3: Selecting from a Scrolling List.

[Settings], **<Pressure>**, **Pressure Unit**, **<All units>**, **MPa**

Continuing from Example 1, Enter **Pressure Unit** and then **<All Units>** presents a list of units with a scroll bar at the right. Rotating the knob clockwise or pressing **▶** scrolls down in the list. Rotating the knob counterclockwise or pressing **◀** scrolls up. Click the knob or **ENTER** to select.

From inside a scrolling list press **ESC** to exit back to the tab screen. From the tab screen, either select another tab, enter the scrolling list again or use **[Back]** or **[Esc]**.

[Back] to go back one menu level to the Settings screen.

[Esc] or **ESC** to exit the menu and make no change.

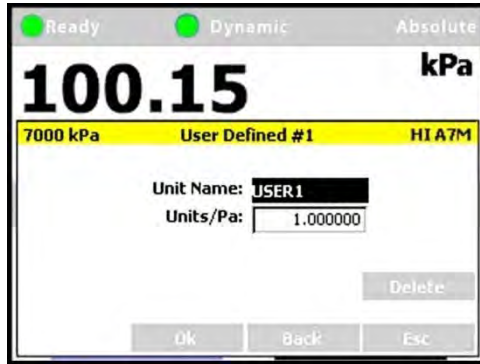

Example 4: Editing a Numeric Value.

[Settings], <Pressure>, Pressure Unit, <User units>, User Defined #1

To create or edit a User defined unit, Enter <User units> in the Unit screen. Enter Units/Pa and input a value using the numeric key pad.

[OK] to accept.

[Back] to go back one menu level to the Settings screen.

[Esc] or **ESC** to return to the Main Run Screen and make no change.

Note

- Whenever the [OK] button is present it is necessary to press [OK] to accept any changes or they will be discarded.
- When highlighted, numeric fields have white text on black backgrounds. When editing, numeric fields change to black text on white background.

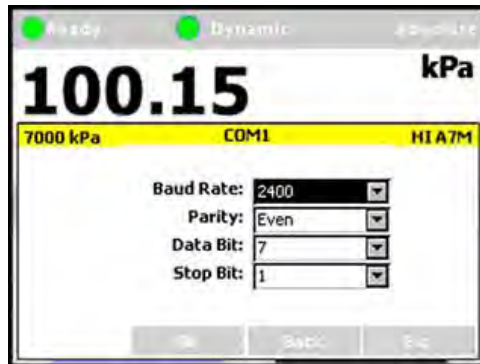

Example 5: Selecting from a Drop Down List.

[Settings], <Remote>, COM1

A field, such as Baud Rate, Parity, Data Bit or Stop Bit in the COM1 screen is in drop down menu format. Enter one of these fields to display a list of the selections available.

Note

When the [OK] button is present it is necessary to press [OK] to accept any changes or they will be discarded.

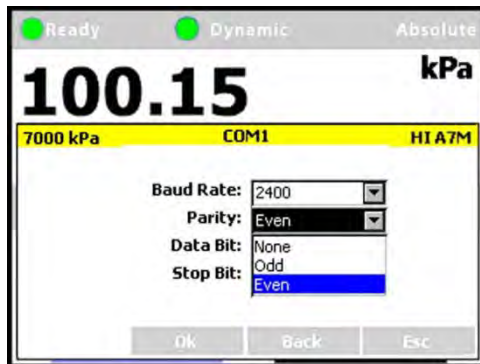

Continuing Example 5, entering Parity displays a list. Select and Enter to accept the new parity value.

[Settings], <Remote>, COM1, Parity

[OK] to accept the changes.

[Esc] or **ESC** to make no change.

Note

When the [OK] button is present it is necessary to press [OK] to accept any changes or they will be discarded.

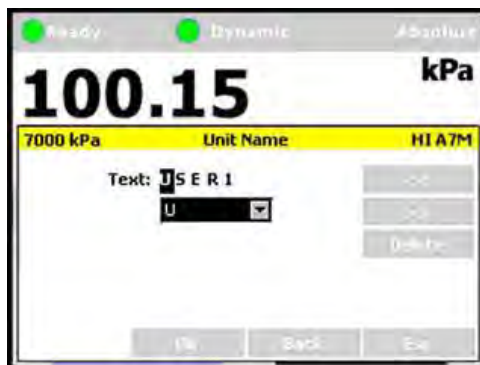

Example 6, editing a text field.

[Settings], <Pressure>, Pressure Unit, <User Units>, User Defined #1, Unit Name

[<<] and [>>] position the cursor over a character. Enter or **ENTER** to open the drop down selection of letters, numbers and symbols. Scroll through the list to select. Enter or **ENTER** the desired character and advance to the next letter.

[Delete] to remove the character.

When the [OK] button is present it is necessary to press [OK] to accept any changes or they will be discarded.

4.5 Pressure Control

4.5.1 Set Pressure Automatically

○ PURPOSE

To use the automated pressure control functions of PPC4E to set and maintain target pressure values (see Section 3.2.11).

○ OPERATION

To set a pressure, **SET P** from the Main Run Screen or click on the **Target Pressure** field of the Main Run Screen. The Set Pressure screen will display with the Target Pressure field highlighted. Using the numeric keypad, enter the target pressure value as desired (see Section 4.5.1.2 for information on zero pressure commands).

Press **ENTER** or click the knob to accept the target value and start the pressure control sequence, returning to the Main Run Screen. The Main Run Screen during active pressure control depends on whether or not the pressure control is *Ready* or *Not Ready* (see Section 3.2.3).

When the pressure is approaching the target (*Not Ready*) the window displays the Measured Pressure and, below, the Target Pressure (labeled Target). The Ready indicator is either Red while pressure is slewing to the target (*Not Ready*) or Yellow (*Near Ready*) when the fine pressure control is approaching the target.

In dynamic control mode (see Section 3.2.2.1), when the pressure has reached the target pressure within the defined Ready criteria, the Target pressure is shown in place of the measured pressure and, below, the difference in actual pressure from target is shown (labeled Deviation). In static control mode (see Section 3.2.2.2), the measured pressure is shown continuously along with Target and Rate.

Observe the *Ready/Not Ready* indicator (see Section 3.2.3) for indication of when the controlled pressure has reached the target and stabilized. PPC4E continues controlling following static or dynamic control operation protocol (see Section 3.2.2) until automated pressure control is interrupted.

4.5.1.1 Interrupting Automated Pressure Control

Automated pressure control is interrupted by:

- **ESC**: Suspends control and remains in Main Run Screen. Does not vent pressure. PPC4E passively measures the pressure applied to its **TEST(+)** port.
- **Selecting any field or shortcut key with the knob or the cursor control keys** **◀**, **▶** and **ENTER**: Suspends control and goes to the selected function. Does not vent pressure. PPC4E passively measures the pressure.
- **Selecting and entering the target pressure screen with the knob or pressing** **SET P**: Suspends control and goes to Set Pressure screen. Does not vent pressure. PPC4E passively measures the pressure applied to its **TEST(+)** port.

To resume automated pressure control, press select and enter the target pressure screen or press **SET P** then **ENTER** a target pressure value.

4.5.1.2 Automated Pressure Commands for Zero Pressure

Zero in gauge mode:

A command for automated pressure control to a target value of zero when in **gauge or negative gauge** measurement mode is interpreted in the same manner as if **VENT** had been pressed (see Section 3.2.13). A *Ready* condition occurs when the vent sequence has completed.

Zero in absolute mode:

In response to a command for automatic pressure control to a target value of zero when in **absolute** measurement mode, PPC4E opens its down control valves fully to the **EXHAUST** port allowing the vacuum source connected to the

EXHAUST port to pull down the pressure as far as possible (see Figure 17). The down valves stay open until another pressure command is given or control is aborted. How low the pressure in the PPC4E and the system connected to the PPC4E **TEST(+)** will go is a function of the quality of the vacuum pump used, the characteristics of the volume and tubing connected to the **TEST(+)** port and PPC4E's internal restrictions.



A *Ready* condition occurs when the pressure control stability limit is reached (see Section 3.2.3). Measured pressure will continue to display even when *Ready*.

4.5.2 Manual Pressure Control



○ PURPOSE



The manual pressure control keys provide direct manual control to increase, decrease, and jog the PPC4E pressure.

○ OPERATION

 or  when automatic control is not active causes pressure to increase or decrease at the fast slew rate.

 or  when automatic control is active produces no response.

 or  when automatic control is not active causes pressure to increase or decrease at the slow slew rate.



 or  during dynamic control causes the pressure to jog or step by a fixed amount. During active dynamic pressure control, they cause the target pressure to be changed by the fixed amount. One press causes one step. The approximate value of the step is set automatically depending on the current active PPC4E range. The value can be adjusted by navigating to [\[Settings\]](#), [<Control>](#), [Jog Step](#) (see Section 4.7.8.3).

4.5.3 Vent

○ PURPOSE



 activates a sequence to bring the test pressure to atmosphere (see Section 3.2.13).

○ OPERATION

 causes PPC4E to control pressure to near atmospheric pressure and then open the system vent valve (see Figure 17 and Figure 18). On-going execution of the vent function is indicated by lighting a RED LED to the left of the  key. Completion of the vent process is indicated by the *Ready/Not Ready* indicator light becoming GREEN with the vent RED LED still lighted. The vent valve remains open until  is pressed again, another direct pressure control key is pressed, or an automated pressure control command is given.

4.6 Graphical User Interface Menus

4.6.1 Shortcuts

All PPC4E functions are available through the Main Run Screen buttons ([\[Tools\]](#), [\[Settings\]](#) and [\[AutoRange\]](#)) and the direct pressure control keys such as  and . Shortcuts give quick access to the most common functions. The shortcut fields are identified in Figure 7 and Table 14. *Enter* a shortcut to navigate directly to the menu associated with that function.

For example, clicking on the [Unit of Measure](#) (see item 11 in Figure 7 and Table 12) is the same as navigating the menu sequence: [\[Settings\]](#), [<Pressure>](#), [Pressure Unit](#). Table 14 lists each shortcut and the associated menu for each.

4.6.2 Menu Structure

Table 14 shows the top level menu structure for the Advanced Interface. Most day to day operations are accessible through the shortcuts (see Section 4.6.1). All functions are available through menus that are grouped by functionality.

Note

[Settings] contains numeric entries that determine how the PPC4E will operate, what calculations will be made and environment and setup commands. Typically Settings functions are entered only to set up the PPC4E prior to performing some action or starting a series of tests.

[Tools] is for action-oriented functions. **[Tools]** functions include AutoTest, Leak Test and other sequences that involve pressure control and measurement. Items in the Tools menu involve some kind of action.

[AutoRange] creates, edits and deletes AutoRanges, optimizing measurement and control of the PPC4E over specified ranges. (See Section 3.2.7)

Table 14. Menu Structure

MENU SELECTION	SHORTCUT (SEE FIGURE)	SEE SECTION
Target Pressure or SET P		4.5.1
[AutoRange]		4.7.1
[Tools], <AutoTest>, Exercise		4.7.2.1
[Tools], <AutoTest>, Quick Test		4.7.2.2
[Tools], <Auto Test>, Advanced Test	AutoTest	4.7.2.3
[Tools], <Pressure>, Purge		4.7.3.1
[Tools], <Pressure>, Leak Test	Leak Test	4.7.3.2
[Tools], <Drivers>		4.7.4
[Tools], <System>, Control Configuration		4.7.5.1
[Tools], <System>, Resets		4.7.5.2
[Settings], <Pressure>, Pressure Unit	Unit of Measure	4.7.6.1
[Settings], <Pressure>, Measurement Mode	Measurement Mode	4.7.6.2
[Settings], <Pressure>, Head	Head	4.7.6.3
[Settings], <Pressure>, Resolution	Measured Pressure	4.7.6.4
[Settings], <Preferences>, Screen saver		4.7.7.1
[Settings], <Preferences>, Sounds		4.7.7.2
[Settings], <Preferences>, Time		4.7.7.3
[Settings], <Preferences>, Language		4.7.7.4
[Settings], <Preferences>, Security		4.7.7.5
[Settings], <Control>	Control Mode	4.7.8
[Settings], <Remote>		4.7.9
[Settings], <Calibration> , Hi RPT, <Calibration>		6.2
[Settings], <Calibration>, Hi RPT, <Uncertainty>	Uncertainty (Hi RPT active)	6.2.7.1
[Settings], <Calibration>, Lo RPT, <Calibration>		6.2
[Settings], <Calibration>, Lo RPT, <Uncertainty>	Uncertainty (Lo RPT active)	6.2.7.1
[Settings], <Calibration>, Barometer		6.3
[Settings], <Internal>		4.7.12

4.7 Menu operation

4.7.1 AutoRange

○ PURPOSE

To automatically set up PPC4E to optimize its measurement and control characteristics and features to cover a specific pressure range (see Section 3.2.7).

○ OPERATION

To use the AutoRange function, use [\[AutoRange\]](#) from the Main Run Screen. The AutoRange screen shows the current settings on the left hand side and a series of buttons on the right for AutoRange actions. [\[OK\]](#) to accept and activate the AutoRange, [\[Back\]](#) or [\[Esc\]](#) to return to the Main Run Screen.

To choose an existing saved AutoRange, select from the contents of the [Range](#): drop down menu and enter an existing range.

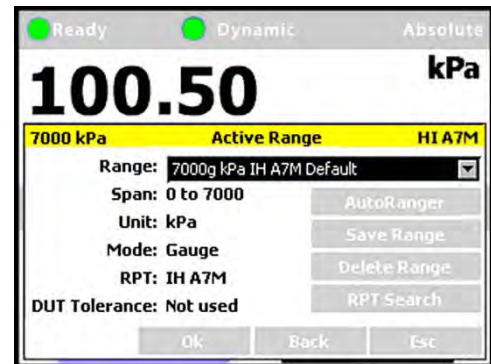

Note

The Default ranges of each of the available RPTs are included in this list, representing the full scale ranges of the RPTs. Default ranges cannot be deleted (see Section 3.2.6).

[\[AutoRanger\]](#): creates a new AutoRange. The AutoRanger screen has the following fields to select:

Unit: The unit of measure associated with the AutoRange (see Section 3.2.9).

Note

Altitude units of measure (m, ft) are not supported for AutoRange.

Mode: The measurement mode associated with the AutoRange (see Section Section 3.2.10). The choice of measurement modes offered reflects the PPC4E model (PPC4E 15K offers gauge and negative gauge modes only).

Full Scale: Edit the full scale pressure value in the unit of measure specified in the Unit field. [\[OK\]](#) to accept. If the full scale pressure entered cannot be covered by any of the RPTs available, an error window is displayed (“No suitable RPTs found”). If the full scale pressure can be covered by an available RPT, the entry is accepted.

Use UUT Tolerance: If this field is “Yes” the UUT Tolerance is used to determine the PPC4E resolution and hold limit settings for the resulting AutoRange. If this field is “No” the resolution and hold limit settings for the resulting AutoRange are determined based on the AutoRange full scale and the active selected RPT.

UUT Tolerance: If enabled, the tolerance of the device under test, in % of AutoRanged span, associated with the resulting AutoRange.

[\[OK\]](#) from the AutoRanger screen continues to the AutoRange Confirmation screen, where the specified Full Scale, Unit, Mode and UUT Tolerance are listed in addition to the selected RPT. Selecting the [RPT](#) drop down list shows all available RPTs that

can cover the specified AutoRange. If an RPT other than the one selected is desired, it may be chosen from this list.

[OK] from the AutoRange Confirmation screen creates the range, [Back] returns to the AutoRanger screen and [Esc] or **ESC** exits to the Main Run Screen and does not create the AutoRange.

[Save Range]: Click to save an AutoRange to the **Range** drop down list.

[Delete Range]: Click to delete the currently selected AutoRange from the **Range** drop down list.

[RPT Search]: To search for, initialize and display RPTs in the PPC4E. Selecting an available RPT changes Range to the default range of that RPT.

Note

- [Esc] from the RPT Search screen the PPC4E will return to the Main Run Screen and no AutoRange changes that were made after the last [Save] will be stored.
- [OK] creates the newly defined AutoRange and to uses it in operation. If a range is selected from the list, [OK] changes the active range to the selected Range. [Esc] returns to the Main Run Screen without changing the currently active AutoRange.
- To verify or confirm the range from the Main Run Screen, use [AutoRange] from the Main Run Screen and view the **Range** field to view the active range (see Section 3.2.7) or view the AutoRange and active RPT spans and indicators from the AutoRanger bar on the main run screen (see Figure 10).

The AutoRange Bar in the middle of the PPC4E Main Run Screen displays the range and a graphical indicator of the measured pressure within the active AutoRanged Span (see Figure 10, showing a pressure of 97.5 kPa on a 500 kPa AutoRanged span).

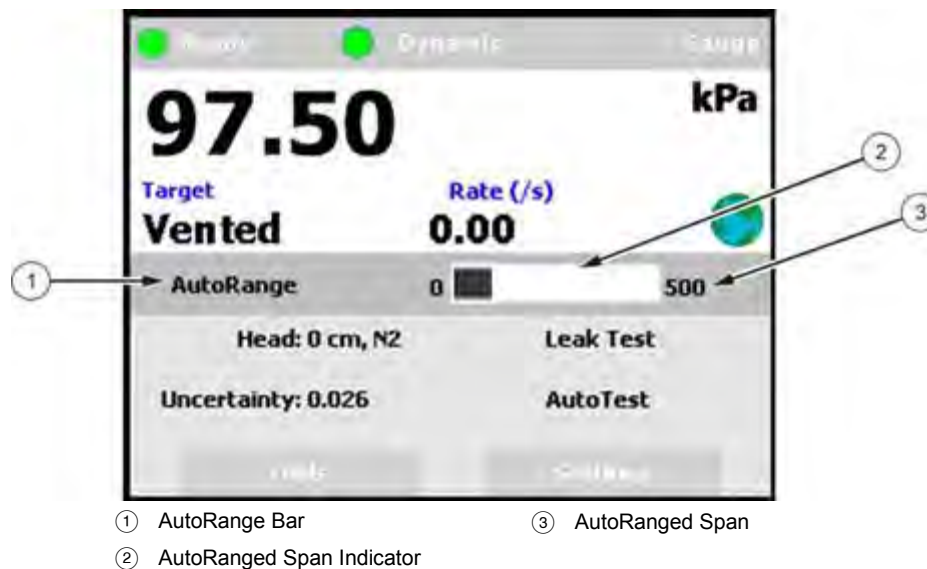

Figure 10. AutoRange Bar

4.7.2 AutoTest

○ PURPOSE

To execute a programmed sequence of automated pressure control target values and/or to AutoRange the PPC4E based on the full scale and tolerance of the device under test (see Section 3.2.14). [Tools], <AutoTest> accesses the main AutoTest menu.

4.7.2.1 Exercise

Exercise cycles pressure with the PPC4E between a minimum value (atmosphere or 0) and a maximum target. The PPC4E can start the descending portion of the cycle immediately or can control at the maximum target for a specified period of time before decreasing pressure.

○ OPERATION

To run an Exercise sequence, **[Tools]**, **<AutoTest>**, **Exercise** from the Main Run Screen.

In the Exercise screen enter the following:

Cycles: The number complete (up and down) cycles for the exercise sequence (0 – 50).

Max Target: The maximum pressure of the target sequence. The PPC4E will control up to this pressure and either release or control at target, based on user selection. Value must be within the Upper and Lower limits of the current AutoRange span (see Section 3.2.7).

Min Target: The minimum pressure of the target sequence, selected from a drop down list. The available selections depend on measurement mode and active RPT type.

Gauge mode: Min=0

Absolute mode: Min=0 or ATM

Negative Gauge mode, Axxx RPT: Min=0

Negative Gauge mode, BGxxx RPT : Min=0 or -Max

Control at Target: From the drop down list, **Yes** to maintain pressure control at Max Target during the Delay time before decreasing pressure. **No** uses a fast ramp and aborts near the target without controlling at the target.

Delay at Target: *Enter* the time at Max Target and Min Target before continuing with the next step in the sequence. If Control at Target is set to **Yes** then pressure control will be maintained during this delay. If Control at Target is set to No then pressure control will abort and the PPC4E will be idle during this delay.

[Back] returns to the AutoTest screen. **[Esc]** or **ESC** exits the Exercise menu and returns to the Main Run Screen. **[OK]** accepts the settings and proceeds to the Exercise Run Screen.

The Exercise Run Screen displays the Cycle count (cycle in progress / total number of cycles) and the Time at Ready which counts down from the Delay at Target value to 0.

In the Exercise Run Screen, **[Start]** to begin the Exercise sequence. At any time, **[Stop]** to abort the sequence and reset the counter. **[Back]** aborts the sequence and returns to the Exercise entry screen. **[Esc]** or **ESC** aborts the sequence and returns to the Main Run Screen.

When the exercise sequence is complete the PPC4E sounds three two second beeps and returns to the main menu.

4.7.2.2 Quick Test

○ OPERATION

To run a Quick Test sequence, [Tools], <AutoTest>, Quick Test from the Main Run Screen.

From the Quick Test screen enter the following:

Max: The maximum test pressure for the sequence. The value must be within the current AutoRange limits (see Section 3.2.7). To change the current AutoRange see Section 4.7.1.

Note

The maximum pressure of the currently available AutoRange is shown in the upper left hand corner of the Quick Test window. See Section 4.7.1.

Min: The minimum test pressure for the sequence.

Step: The step size in % of test sequence span (Max-Min). Test will run with pressure steps of (Max-Min)*Step% with the uneven increment at the Max pressure if applicable.

Direction: Direction of test execution.

Up – starts at Min and ends at Max

Down – starts at Max and ends at Min

Up/Down – sequence runs from Min to Max and back to Min

Down/Up – sequence runs from Max to Min and back to Max

[OK] to accept test settings and continue. [Back] to return to <AutoTest>. [Esc] or **ESC** to exit to the Main Run Screen.

In the next screen enter the following:

Continue Mode: From the drop down list choose User or Timer. If User is chosen the test sequence will proceed to the next target value only after **ENTER** or the knob is pressed. If the Timer is selected then the next test sequence will proceed after the timer value has elapsed.

Timer: The time, in seconds, the pressure will hold at each step if the Timer mode is selected. Timer can be between 1 and 9999 seconds.

[OK] to accept settings and continue to the Quick Test run screen, [Back] to return to the Quick Test setup screen or [Esc] or **ESC** to exit to the Main Run Screen.

In the Quick Test Run Screen, [Start] begins the Quick Test sequence. Once the sequence begins, the Point counter displays current sequence increment / total increments. If the control mode is dynamic (see Section 3.2.2.1), once a *Ready* condition has been achieved (see Section 3.2.3) **▲** and **▼** can be used to adjust the pressure set by the PPC4E until the UUT reaches the cardinal value of the pressure increment using the Jog function (see Section 3.2.19). In User Continue Mode, once the UUT has reached the cardinal value of the pressure increment then use [Next Point]. In Timer Continue Mode, once the pressure is *Ready*, the sequence will proceed automatically after the delay has elapsed.

Note

While the Quick Test is running, the upper half of the display is exactly the same as the Main Run Screen, displaying the Ready indicator, control indicator, measured pressure, target pressure and pressure rate of change. See Section 4.1.

At any time during the sequence, [Previous Point] causes the PPC4E to go back and retake the previous test point. [Next Point] stops the current point and moves to the next test point in the sequence. On the last test point [Stop] is shown instead of [Next Point]. Completing the last point or [Stop] moves to the Quick Test summary screen.

[Back] aborts the sequence and returns to the previous screen. [Esc] or **ESC** aborts the sequence and returns to the Main Run Screen.

Once the test is complete the results are shown on the Quick Test summary screen. The pressure values from the PPC4E are shown with the respective sequence numbers. If there are more than eight points in the test then a scroll bar is shown.

[Back] returns to the Quick Test Run Screen to start the same test sequence again. [Esc] or **ESC** returns to the Main Run Screen.

4.7.2.3 Advanced Test

The Advanced Test provides the opportunity to create, save and run up to 20 test sequences with greater flexibility than with Quick Test.

○ OPERATION

To run, edit or delete an Advanced Test sequence, [Tools], <AutoTest>, Advanced Test from the Main Run Screen.

At the top of the Advanced Test screen is the Test field, with a drop down list of previously saved Advanced Test sequences. To run a test from this list, select the test.

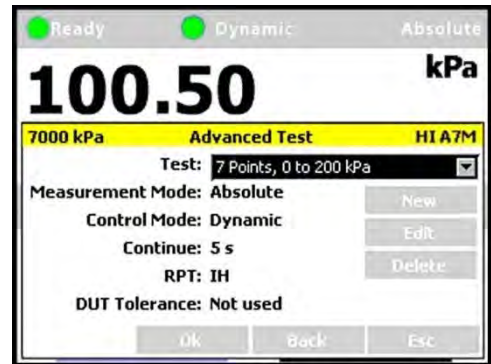

Note

The summary information of the test is then shown in the Test: field as well as in the information fields on the left side of the screen. Checking this information helps to ensure that the correct sequence is being run and that it will not exceed the maximum pressure of the UUT.

From the Advanced Test main screen, selections include:

- [New] Create a new Advanced Test.
- [Edit] Edit an existing Advanced Test.
- [Delete] Deletes the active Advanced Test
- [OK] Runs the active Advanced Test
- [Back] Returns to the [Tools], <AutoTest> tab
- [Esc] or **ESC** exits to the Main Run Screen

4.7.2.3.1 New Test

[Tools], <AutoTest>, Advanced Test, [New] initiates creation of an Advanced Test. The first step in creating an Advanced Test is to create an AutoRange for the test span (See Section 4.7.1).

In the AutoRanger screen there are fields to select or enter values.

Unit: The unit of measure associated with the AutoRange.

Mode: The measurement mode associated with the AutoRange. The choice of measurement modes offered reflects PPC4E model (PPC4E 15K offers gauge and negative gauge modes only).

Full Scale: Enter the full scale pressure value in the unit of measure specified in the Unit field and [OK] to accept. If the full scale pressure entered cannot be covered by any of the RPTs available, an error window is displayed (“No suitable RPTs found”). If the full scale pressure can be covered by an available RPT, the entry is accepted.

Use UUT Tolerance: If this field is “Yes” the UUT Tolerance is used to determine the PPC4E resolution and hold limit settings for the resulting AutoRange. If this field is “No” the resolution and hold limit settings for the resulting AutoRange are determined based on the AutoRange full scale and the active selected RPT.

UUT Tolerance: If enabled, the tolerance of the device under test, in % of AutoRanged span, associated with the resulting AutoRange. Used to determine control limits and to determine pass/fail for test results.

[OK] from the AutoRanger screen enters the AutoRange Confirmation screen, where the specified Full Scale, Unit, Mode and UUT Tolerance are listed in addition to the selected RPT. Selecting the RPT drop down list shows all available RPTs that can cover the specified AutoRange. If an RPT other than the one selected is desired, it may be chosen from this list. Back to return to the AutoRanger screen. [Esc] or Esc exits to the Main Run Screen.

[OK] from the AutoRange Confirmation screen creates the range and continues, [Back] returns to the previous screen. [Esc] or Esc exits to the Main Run Screen.

Continuing enters the Advanced Test editing screen where test values are listed on the left and test sequence editing buttons are given on the right.



Note

The pressure unit for the test points is shown to the right of the test value list and may be different from the current, active unit of measure (see Section 3.2.9).

To edit the numerical value of a test point:

Select the entry in the test value list and *Enter* or **ENTER** to access the list.

Select the test point to edit.

Enter or **ENTER** again to choose the point and exit to the Test Point field.

The counter shows which test point is active (test point number / total number of points).

Edit the value of the test point with the numeric keypad.

Enter or **ENTER** to accept the edited value.

[Auto Fill]: This function creates a test sequence of uniform steps. From the next screen enter the following:

Max: The maximum test pressure for the sequence. The value must be within the newly created AutoRange limits. **[Back], [Back]** to edit this AutoRange.

Min: The minimum test pressure for the sequence.

Step: The step size in % of test sequence span (Max-Min). Test will run with pressure steps of (Max-Min)*Step% with the uneven increment at the Max pressure if applicable.

Direction: Direction of test execution.

Up – starts at Min and ends at Max

Down – starts at Max and ends at Min

Up/Down – sequence runs from Min to Max and back to Min

Down/Up – sequence runs from Max to Min and back to Max

[OK] to accept and activate the Auto Fill settings and return to the Advance Test edit screen. **[Back]** to return to the previous screen without making changes. **[Esc]** or **ESC** to exit and return to the Main Run Screen without saving the test.

[Add]: Adds a Test Point below the currently active (highlighted) point in the test list. The new point is created with the same numerical value as the point above it. The value of the new test point can be edited immediately using the numeric keypad.

To add another point below the first, **[Add]** again.

To add another point at a different location, *Select* the entry in the test value list, *Enter* and *Select* the point that will be above the new point. *Enter* then **[Add]** as before.

[Add ATM]: Adds an atmospheric (vent) point below the currently active point in the test list. The new point value is shown as “ATM”.

[Delete]: Deletes the currently active point in the test list. After deleting the point below the deleted point becomes the active point.

[Delete All]: Deletes all of the points in the test list.

[OK] to continue to the next screen. **[Back]** to return to the AutoRanger. **[Esc]** or **ESC** to exit and return to the Main Run Screen.

Continuing from the Advanced Test setup screen to the next screen. Enter the following:

Continue Mode: From the drop down list choose User or Timer. If User is chosen the test sequence will proceed to the next target value only after **ENTER** or the knob is pressed. If the Timer is selected then the next test sequence will proceed after the timer value has elapsed.

Timer: The time, in seconds, the pressure will hold at each step if the Timer mode is selected. Timer can be between 1 and 9999 seconds.

Control Mode: Choose Static or Dynamic control mode (see Section 3.2.2).

[OK] to accept the new Advanced Test and return to the Advanced Test main screen, [Back] to return to the previous screen or [Esc] or  to exit to the Main Run Screen.

4.7.2.3.2 Edit Test

[Tools], <AutoTest>, Advanced Test, [Edit] opens the currently selected Advanced Test sequence for editing.

Note

- Editing an Advanced Test sequence follows the same steps as creation of a New Test (See Section 4.7.2.3.1), starting with the AutoRange.
- Editing any field in the AutoRanger screen will cause the test points to be regenerated automatically as default values. Any changes to the AutoTest sequence need to be made from the Advanced Test editing screen.

After all changes have been made, from the Advanced Test “Continue mode” screen, [OK] to accept and save the edited Advanced Test. [Back] to return to the previous screen. [Esc] or  to exit and return to the Main Run Screen without making a change to the selected Advanced Test.

4.7.2.3.3 Delete Test

[Tools], <AutoTest>, Advanced Test, [Delete] deletes the currently active Advanced Test.

⚠ Caution



Be sure to select the test that is to be deleted before using [Delete]. Verify that the test sequence listed in **Test:** represents the test that is to be deleted. Once a test is deleted it cannot be retrieved and must be recreated.

4.7.2.3.4 Run Advanced Test

[Tools], <AutoTest>, Advanced Test, [OK] runs the selected AutoTest.

Note

Before running an advanced test, first select from the [Test] drop down menu the Advanced Test that is to be executed. If the desired test is not present then a new test will need to be created (See Section 4.7.2.3.1).

In the Advanced Test Run Screen, [Start] begins the Advanced Test sequence. Once the sequence begins, the Point counter displays current sequence increment / total increments. If the control mode is dynamic (see Section 3.2.2.1), once a *Ready* condition has been achieved (see Section 3.2.3)  and  or the front panel knob can be used to adjust the pressure set by the PPC4E until the UUT reaches the cardinal value of the pressure increment using the Jog function (see Section 3.2.19). In User Continue Mode, once the UUT has reached the cardinal value of the pressure increment then use [Next Point]. In Timer Continue Mode, once the pressure is Ready, the control will sequence will proceed automatically after the delay has elapsed.

Note

While the Advanced Test is running, the upper half of the display is exactly the same as the Main Run Screen, displaying the Ready indicator, control indicator, measured pressure, target pressure and pressure rate of change. See Section 4.1.

At any time during the sequence, [Previous Point] causes the PPC4E to go back and retake the previous test point. [Next Point] stops the current point and moves to the next test point in the sequence. On the last test point [Stop] is shown instead of [Next Point]. Completing the last point or [Stop] moves to the Advanced Test summary screen.

[Back] aborts the sequence and returns to the previous screen. [Esc] or  aborts the sequence and returns to the Main Run Screen.

Once the test is complete the results are shown on the Advanced Test summary screen. The pressure values from the PPC4E are shown with the respective sequence numbers. If there are more than eight points in the test then a scroll bar is shown.

Note

Select and Enter the highlighted number in the list to scroll.

If UUT Tolerance is used (specified in the AutoRanger screen, see Section 4.7.2.3.1) then the summary screen will also include “pass”, “fail” or “ATM” for each point in the sequence. The criteria for pass/fail assumes that the UUT is adjusted to the cardinal values of each test point and calculates an error based on the difference between the test point and the PPC4E reading.

Pass: The difference between the PPC4E pressure and the UUT is less than or equal to the UUT Tolerance, expressed as a percent of AutoRange span.

Fail: The difference between the PPC4E pressure and the UUT is greater than the UUT Tolerance.

N/A: Targets of 0 and Vent do not have pressure adjustment for UUT cardinal point. Pass/Fail determination is not applicable.

[Back] returns to the Advanced Test Run Screen to start the same test sequence again. [Esc] or  returns to the Main Run Screen.

4.7.3 Pressure

The [Tools], <Pressure> tab contains the utility pressure functions Purge and Leak Test. The [Tools], <Pressure> screen displays the Purge enable status and the results of the last successful Leak test. If the Purge function is enabled (see Section 4.7.12.3) then the display shows <Purge: On>. If the Purge function is disabled then the display shows <Purge: Off>. The Leak Test results show the results of the last successful Leak Test in rate (Units/s) and pressure change in the Units active at the time of the test.

4.7.3.1 Purge

○ PURPOSE

To execute the PPC4E test system Purge function using the optional Self Purging Liquid Trap (SPLT). Purge is used to collect and exhaust liquid contaminants from the device or system under test before they reach the PPC4E (see Section 3.2.16).

○ OPERATION

Note

For the Purge function to execute, the function must have been enabled using [Settings], <Internal>, Purge, On (see Section 4.7.12.3) and an optional Self Purging Liquid Trap (SPLT) must be installed in the test line (see Section 2.3.6.1). When the purge function is enabled the Main Run Screen will show **Purge: On** for the Purge shortcut field.

To purge the UUT and/or system under test using the PURGE function, proceed as follows:

- ❶ **Connect the system or device under test (UUT) to the PPC4E TEST(+) port:**
Make sure the optional SPLT is properly installed between the UUT and the PPC4E, TEST(+) port including the electrical connection for the PPC4E DRIVER connector to the SPLT valve.
- ❷ **Set the purge pressure:** Use the PPC4E direct pressure control keys (see Section 3.2.1) or automated pressure control (See Section 4.5.1) to the set purge pressure. The purge pressure should be roughly the UUT full scale or 1 MPa (150 psi), whichever is lower. Avoid activating the purge function at pressure > 1 MPa (150 psi).
- ❸ **Purge, [Start] or [Tools], <Pressure>, Purge, On from the Main Run Screen:**

Note

ESC or [Stop] at any time during execution of the purge routine causes the purge function to abort and returns to the Main Run Screen.

PPC4E controls pressure down to less than 700 kPa (100 psi), stops control and displays <Preparing to purge> for five seconds. After the five second delay, PPC4E opens the SPLT exhaust valve and displays <Purging...>.

Once the pressure reaches less than 20 kPa (3 psi) gauge or 110 kPa (16 psi) absolute, PPC4E opens its internal vent valve and returns to the Main Run Screen in its normal vented condition.

The PPC4E will beep three times to signal the completion of the Purge routine.

- ❹ Repeat steps ❷ and ❸ until no liquids or other contaminants are expelled when the SPLT exhaust valve opens.

4.7.3.2 Leak Test

○ PURPOSE

To run an automated leak check routine that determines the leak rate of the system connected to the PPC4E TEST(+) port (see Section 3.2.17).

○ OPERATION

To run a leak check, first set the pressure to the desired leak check pressure using the direct pressure control keys (see Section 3.2.1) or automated pressure control (See Section 4.5.1)

To access the Leak Test function, use [Tools], <Pressure>, Leak Test from the Main Run Screen. The shortcut for Leak Test is **Leak Test** on the Main Run Screen.

Edit the leak test time, in seconds (minimum 2, maximum 999). **ENTER** or *Enter* to accept the value. [Start] to begin the test.

[Stop] aborts the running leak test. [Start] once more restarts the leak check timer. At any time during leak test [Esc] or **ESC** aborts and returns to the Main Run Screen.

While the leak test is in process the Average Rate and the total change in pressure (dP) are displayed using the currently active unit of measure, with

values updated throughout the test. When the leak check timer countdown has finished, the result is shown in the displayed values for Average Rate and dP.

[Start] to run another leak test. [Back] to return to [Tools], <Pressure>. [Esc] or **ESC** to exit to the Main Run Screen.

[Tools], <Pressure> displays the results of the most recently completed leak check as well as the Purge enable status. The Leak Test results show the results of the last successful Leak Test in rate (Units/s) , pressure change in the Units and the RPT active at the time of the test. If NO leak check data is stored (i.e., if the PPC4E has never run a leak test or a reset has cleared previous leak test results), <Pressure> displays <Leak Test: None>.

4.7.4 Drivers

○ PURPOSE

To control the output signals of PPC4E's 8 channel, 12 V external drivers (see Section 3.2.21).

Note

See Section 8.1 for driver specifications and pin-outs.

○ OPERATION

[Tools], <Drivers> opens the driver control screen. Select the driver to change. Enter or **ENTER** to change state (On/Off).

When a driver is On, voltage is applied. ●

When a driver is Off, voltage is not applied. ○

⚠ Caution

The PPC4E Purge function makes use of the valve driver option. Valve driver number 8 is used to actuate the SPLT exhaust valve. The SPLT exhaust valve is actuated when performing the Purge function and in the background every time the PPC4E Vent function is used. When making use of valve drivers, note that when the Purge function is enabled, valve driver number 8 will be actuated independently of user initiated valve driver commands (see Section 3.2.16).

[Esc] or **ESC** exit to the Main Run Screen.

4.7.5 System

Use [Tools], <System> to access **Control Configuration** and **Resets**.

4.7.5.1 Control Configuration

○ PURPOSE

This function is considered part of PPC4E maintenance and is therefore covered in the maintenance section of this manual. See Section 6.4.

○ OPERATION

This function is considered part of PPC4E maintenance and is therefore covered in the maintenance section of this manual. See Section 6.4.

4.7.5.2 Reset

○ PURPOSE

To reset various PPC4E settings to default or factory values. Use [Tools], <System>, **Resets** to access the Reset functions (see Section 3.2.23).

⚠ Caution

PPC4E reset functions will change current settings to factory defaults. These may include settings vital to PPC4E operation and affecting the calibration of the quartz reference pressure transducers (RPTs). Reset functions should only be used by qualified personnel with knowledge of reset consequences. Reset functions should not be used experimentally.

4.7.5.2.1 Settings**○ PURPOSE**

Sets most general operating parameters back to default values. Does not affect calibration coefficients, remote interfaces or AutoRange ranges (see Section 3.2.23.1).

○ OPERATION

From the Main Run Screen use **[Tools], <System>, Reset, Settings.**

[Yes] to activate changes (perform the reset). The PPC4E will cycle power to complete and return to the Main Run Screen. **[No]** to make no changes and return to the Reset screen.

4.7.5.2.2 Units**○ PURPOSE**

Resets Unit selections to factory defaults (see Section 3.2.23.2).

○ OPERATION

From the Main Run Screen use **[Tools], <System>, Reset, Units.**

[Yes] to activate changes (perform the reset). The PPC4E will cycle power to complete and return to the Main Run Screen. **[No]** to make no changes and return to the Reset screen.

4.7.5.2.3 AutoTest**○ PURPOSE**

Resets Exercise, Quick Test and Advanced Test to default characteristics (see Section 3.2.23.3).

○ OPERATION

From the Main Run Screen use **[Tools], <System>, Reset, AutoTest.**

[Yes] to activate changes (perform the reset). The PPC4E will cycle power to complete and return to the Main Run Screen. **[No]** to make no changes and return to the Reset screen.

4.7.5.2.4 Calibration**⚠ Caution**

The Reset Calibration function will reset RPT, utility sensor and barometer calibration coefficients and settings. This will change the PPC4E calibration and could cause it to make out of tolerance measurements.

Clears all user values affecting the calibration of RPTs, utility sensor and the on-board barometer. Does not clear factory coefficients (see Section 3.2.23.4).

○ OPERATION

From the Main Run Screen use **[Tools], <System>, Reset, Calibration**

[Yes] to activate changes (perform the reset). The PPC4E will cycle power to complete and return to the Main Run Screen. **[No]** to make no changes and return to the Reset screen.

4.7.5.2.5 Reset All

Caution

The Reset All function clears and deletes large amounts of user defined information including critical calibration data.

Combines all resets in one global reset command that clears the entire user section of non-volatile memory returning PPC4E to the “as delivered” condition except the ID function and the security level password. (See Section 3.2.23.5).

○ OPERATION

From the Main Run Screen use **[Tools], <System>, Reset, Reset All [Yes]** to activate changes (perform the reset). The PPC4E will cycle power to complete and return to the Main Run Screen. **[No]** to make no changes and return to the Reset screen.

4.7.6 Pressure

Use **[Settings], <Pressure>** to access **Pressure Unit, Measurement Mode, Head and Resolution**. The **[Settings], <Pressure>** tab displays the current values of each of these four settings. *Select* and *Enter* to edit settings.

4.7.6.1 Pressure Unit

○ PURPOSE

To select the unit of pressure in which PPC4E displays pressure values.

Note

For information on selecting the measurement mode (absolute, gauge, negative gauge), see Section 4.7.6.2.

○ OPERATION

[Settings], <Units>, Pressure Unit opens the Pressure Unit screen. The shortcut for Pressure Unit is the Unit field on the Main Run Screen. The Pressure Unit screen has three tabs.

<Favorites> Lists the most recently selected units.

<All Units> Lists all available units.

<User Units> Lists units defined by the user.

[Back] to return to the Main Run Screen, **[Esc]** or **ESC** to exit to the Main Run Screen.

Note

The pressure measurement unit selected is range specific. When in a given range, all functions and settings are represented in the current measurement unit for that range. However, certain internal and/or metrological functions (e.g., RPT calibration coefficients) are always represented in Pa regardless of the active range unit of measure. In addition, when the active unit is an altitude unit, the range and upper limit indications are in kPa if the unit is meters (m) and psi if the unit is feet (ft).

4.7.6.1.1 Favorites

The Favorites tab in the Pressure Unit menu lists up to ten of the most recently used units for quick and easy selection. *Select* and *Enter* the unit selection. After the unit has been chosen the PPC4E returns to the Main Run Screen with the new unit active.

Note

Every time a new unit is selected from the All Units list (see Section 4.7.6.1.2) the new unit is added to Favorites.

[Reset] to erase the list of Favorites, [Back] to return to <Pressure>, [Esc] or **ESC** exit to the Main Run Screen without making a change.

4.7.6.1.2 All Units

If the desired unit has not been used recently and is not in the Favorites list, then <All Units> can be selected. The All Units tab provides a scrolling list of all selectable units. These include the five user defined units (see Section 4.7.6.1.3).

First *Enter* the scrolling list then scroll through and *Select* the desired unit of measure. **ENTER** or *Enter* to select, **ESC** to exit the menu.

Note

Units representing a water column (inches/meters/millimeters of Water) are all represented with a selection of temperatures from which to calculate density. The temperature is part of the unit definition. Choose from 4 °C, 20 °C or 60 °F. For example, the unit for inches of water at 20 ° is inH₂O@20C.

[Back] to return to the <Pressure> tab, [Esc] or **ESC** exit to the Main Run Screen without making a change.

4.7.6.1.3 User Units

If a unit of measure is needed that is not among the predefined units then up to five user defined units may be created. To create a user defined unit first the conversion from the new unit to Pascal (Pa) must be specified. In order to edit a user defined unit, select [Settings], <Pressure>, Pressure Unit, <User Units>. Then *Select* which of the five User Defined units to edit.

To edit the name using the text editing screen, *Select* and *Enter* the Unit Name field. *Selecting* and *Entering* a letter allows brings up the character drop down list. *Enter* to accept a replacement character, **ESC** to exit the drop down list. Scroll left and right by using [←] and [→]. [Delete] to erase the current character.

[OK] to accept and return to the Unit edit screen, [Back] to reject changes and return to the Unit edit screen, [Esc] or **ESC** to reject changes and exit to the Main Run Screen.

Enter the appropriate value for the number of Units/Pa in the second field of the User Defined unit screen. For example, the unit kiloPascal (kPa) would have Units/Pa equal to 0.001.

[OK] to accept and return to the Main Run Screen, [Back] to reject changes and return to the <User Units> tab, [Esc] or **ESC** exit to the Main Run Screen without making a change.

4.7.6.2 Measurement Mode**○ PURPOSE**

To set the measurement mode (absolute, gauge or negative gauge) for the active range (see Section 3.2.10).

○ OPERATION

[Settings], <Pressure>, Measurement Mode brings up the Measurement Mode screen with the available mode selections. The shortcut to Measurement Mode is the measurement mode field from the Main Run Screen (see Figure 7). *Select* and *Enter* to change the selected mode and return to the Main Run Screen with the new mode active.

If an Axxx RPT or a utility sensor is active, all three measurement modes are supported: absolute, gauge and negative gauge. If absolute and negative gauge modes are OFF then only gauge mode is available. (see Section 6.2.5).

[Back] to return to <Settings>. [Esc] or **ESC** to return to the Main Run Screen without making a change.

Note

Absolute and negative gauge modes on an Axxx RPT can be turned OFF in the calibration function (see Section 6.2.5). When absolute and negative gauge modes are turned OFF for an Axxx RPT, only gauge mode can be activated.

4.7.6.3 Head

○ PURPOSE

To cause a pressure fluid head correction to be added or subtracted to the pressure measured by the PPC4E reference pressure transducer in order to predict the pressure at a height other than the PPC4E's reference level (see Section 3.2.15).

Note

Use of the Head function to ensure in tolerance measurements is most important in low absolute pressure ranges. Specifying the head height within ± 3 in. (7.5 cm) is adequate to ensure that, even in the worst case, the uncertainty on the head correction will be insignificant relative to the tolerance on the measurement.

○ OPERATION

[Settings], <Pressure>, **Head** opens the Head screen. The shortcut to Head is **Head**: on the Main Run Screen (see Figure 7). In this screen edit:

Height: The height of the UUT or measured pressure above the reference level of the PPC4.

The reference height of the PPC4E pressure measurement is the middle of the PPC4E TEST port. The head height should be entered as a positive value if the device or system under test is higher than the PPC4E and negative if it is lower.



Unit: The unit of measure of the height measurement (centimeters or inches)

Medium: The fluid medium in the test connection between the TEST(+) port and the UUT or measured pressure.

After editing values, [OK] to accept changes and return to the Main Run Screen. [Back] to return to <Pressure>. [Esc] or **ESC** exit to the Main Run Screen without making a change.

Note

- The currently active head values can be seen on the [Head](#) shortcut on the Main Run Screen (see Figure 7). The height, unit and medium are shown. For example: [Head: 0 cm, N2](#) represents no head correction because the height is equal to 0.
- The Head function is NOT range specific. The Head ON or OFF status remains the same as ranges are changed. Edits made to the head settings are independent of active range or RPT.

4.7.6.4 Resolution**○ PURPOSE**

To set the resolution with which measured pressures and other pressure indications and settings are displayed.

○ OPERATION

[\[Settings\]](#), [<Pressure>](#), [Resolution](#) opens the Resolution screen. The shortcut to Resolution is the measured pressure field from the Main Run Screen (see Figure 7). In the resolution window choose from the available choices between 1.0% of full scale and 0.0001% of full scale. The currently active resolution value is shown in gray.

[\[Back\]](#) to return to [<Pressure>](#). [\[Esc\]](#) or [ESC](#) to exit to the Main Run Screen without making a change.

Note

- The resolution setting is range specific. A resolution setting made in one range does NOT affect other ranges.
- The measured pressure resolution is fixed for altitude units at 1 m in meters and 1 ft in feet.
- The maximum resolution setting is limited in AutoRange ranges that are less than 10% of the RPT default full scale.
- The maximum resolution setting when using a utility sensor is 0.001% of utility sensor span.

4.7.7 Preferences

Use [\[Settings\]](#), [<Preferences>](#) to access [Screen Saver](#), [Sounds](#), [Time](#), [Language](#) and [Security](#). The [\[Settings\]](#), [<Preferences>](#) tab displays the current values of each of these settings. *Select* and *Enter* to edit settings.

4.7.7.1 Screen Saver**○ PURPOSE**

To adjust the PPC4E's Screen Saver settings (see Section 3.2.24.1).

○ OPERATION

[\[Settings\]](#), [<Preferences>](#), [Screen Saver](#) opens the Screen Saver screen. Edit [Time](#), from 10 minutes to 8 hours. If Time is set to Off then the screen saver function will be disabled and the screen will remain on as long as the PPC4E power is on. Editing [Style](#) chooses the display when the screen saver is activated. The choices include "Moving Pressure" which displays the current measured pressure, moving on the screen, and "DHI" (the DHI logo).

[OK] to accept and return to the Main Run Screen. [Back] to return to <Preferences>. [Esc] or **ESC** to return to the Main Run Screen without making a change.

4.7.7.2 Sounds

○ PURPOSE

To adjust or suppress the PPC4E key press sound (see 3.2.24.2).

○ OPERATION

[Settings], <Preferences>, **Sounds** opens the Sounds screen. From here choose **None**, **Low**, **Medium** or **High** for the valid key press frequency. The currently active frequency is shown in gray.

Choose **None** to suppress the key press tone.

Select and *Enter* to choose the desired sound and return to the Main Run Screen.

[Back] to return to <Preferences>. [Esc] or **ESC** return to the Main Run Screen without making a change.

4.7.7.3 Time

○ PURPOSE

To view and edit the PPC4E internal time and date settings (see Section 3.2.24.3).

○ OPERATION

Note

The PPC4E date and time are set to United States Mountain Standard Time in the final test and inspection process at the factory. If desired, use the Time and Date functions to set your local time and date.

The PPC4E has an internal real time clock that is used for date and time stamping calibrations and internal logs.

[Settings], <Preferences>, **Time** accesses the PPC4E date and time settings. Select and edit these fields to set the time as desired. The year is in year/month/day format (yyymmdd). Time may be displayed in either a 12 hour (AM/PM) or 24 hour format, set by editing **Time Style**. If **Time Style** is 24 hour then **AM/PM** is blank.

4.7.7.4 Language

○ PURPOSE

To specify the language for PPC4E Advanced Interface display, headings, menus and screens (see 3.2.24.4).

○ OPERATION

[Settings], <Preferences>, **Language** opens the Language screen. Select the preferred language for on screen display and *Enter*. The currently active language is shown in gray.

Select a language and *Enter* or **ENTER** to change languages and return to the Main Run Screen. [Back] to make no change and return to <Preferences>. [Esc] or **ESC** to make no change and exit to the Main Run Screen.

Note

- The language selection affects to headings, buttons, tabs, field names and on-screen messages. Numeric displays, including pressure units and DHI trademarked terms, such as AutoRange, are always in English.
- Remote commands and their responses are always in English, regardless of language setting.

4.7.7.5 Security**○ PURPOSE**

To set user protection levels to restrict access to certain functions and to edit the password required for changing user levels (see Section 3.2.24.5).

○ OPERATION

[Settings], <Preferences>, Security accesses the PPC4E Security screen. PPC4E is delivered with no active password and access to the Security screen is open. The security level is set to **Low**. Security levels can be changed freely until a password has been created.

To change the Security level, access the security screen, [Settings], <Preferences>, Security. If there is a password in place, the Password screen will be displayed. Enter the password at the prompt "Enter Password:". If no password has been entered the Security screen will be displayed immediately, bypassing the Password screen.

Note

At the bottom left of the Password entry screen is a code (SN: sss-nnnn). The first part (sss) is the PPC4E serial number. The second part (nnnn) is a number that is changed each time the secondary password is used (see 3.2.24.5).

Select and Enter a Security from the choices, **Off**, **Low** or **High** (see Table 11 for function access affected by the security level).

Entering a choice makes the change and returns to the Main Run Screen. [Back] returns to <Preferences> without making a change. [Esc] or  exit to the Main Run Screen without making a change.

4.7.7.6 Edit Security Password

[Edit Password] from Security opens the password editing screen. Passwords can be up to six numbers in length and cannot start with a zero. If <0> is entered, the password is made inactive and the user will not be required to enter a password to access the user level menu. This condition, with a security level of **Low**, is the factory default.

 Caution

Once a password has been entered, the user level cannot be changed without reentering the password or the secondary password.

Note

The factory secondary password is available in case the user's password has been misplaced or forgotten. It can be obtained by contacting a FLUKE CALIBRATION Authorized Service Center (see Table 31). The factory secondary password is different for all PPC4E's and changes each time it is used.

[OK] to accept the change and return to Security. [Back], [Esc] or  exit to Security without making a change.

4.7.8 Control

4.7.8.1 Pressure Limits

○ PURPOSE

To set the upper and lower limit pressure value for a pressure range and measurement mode (see Section 3.2.20).

○ OPERATION

[Settings], <Control>, Pressure Limits opens the screen to edit or reset the Upper and Lower Limits.

To modify the upper limit, edit the value, noting the pressure units associated with this value. [OK] to accept changes and return to the Main Run Screen. [Back] to return to <Control> and make no changes. [Esc] or  to exit to the Main Run Screen and make no changes.

Note

- If the current measurement mode is absolute or gauge, there is an upper limit only. The maximum upper limit is 105 % of AutoRange range or 102 % of default RPT range, whichever is smaller.

For negative gauge mode ranges, the lower limit is –ATM for ranges where the maximum is greater than or equal to +ATM and negative of the upper limit for ranges where the maximum is less than +ATM. The value may be edited but must be negative. To restore the default value use [Default Limits].

Note

- The lower limit must be a negative value.
- The default lower limit for a negative gauge mode ranges less than or equal to \pm ATM is the negative equivalent of the upper limit

[Default Limits] resets the Upper and Lower Limits to the default values for the active RPT and range.

[OK] to accept the changes and return to the Main Run Screen. [Back] to return to <Control> without making changes. [Esc] or  to exit to the Main Run Screen without making changes.

Caution

Upper limit values are specific to each range and measurement mode. Be careful not to assume that the upper limit set in one measurement mode will apply to the other. For example, if you set 150 kPa as the upper limit in gauge mode, the upper limit will not be 150 kPa in negative gauge mode of the same range.

Note

Upper limits are always specified and displayed in the current pressure unit except for altitude units. When in altitude units, upper limits are expressed in kPa if the altitude unit is meters (m) and psi if the altitude unit is feet (ft).

4.7.8.1.1 Over Pressure Function

In addition to the UL function, PPC4E has an over pressure function (see Section 3.2.20.1).

To recover from an overpressure condition, correct the overpressure condition and cycle PPC4E power. Be sure to correct the condition that caused the overpressure before cycling power.

4.7.8.2 Pressure Control

○ PURPOSE

To set the automated pressure control mode for the active range, customize control parameters, activate default control parameters (see Section 3.2.2).

○ OPERATION

[Settings], <Control>, Pressure Control opens the screen to select the control mode and to set the control limits.

Select **Static** or **Dynamic** to change to that control mode and exit to the Main Run Screen. The shortcut to **Pressure Control** is the **control mode** indicator on the Main Run Screen (see Figure 7).

Select [Limits] from the Pressure Control screen to adjust or view the Control Parameters.

Note

Control mode setting is range specific. A change in control mode made while in one range does NOT affect the control mode setting in other ranges.

4.7.8.2.1 Custom Control Parameters (Limits)

○ PURPOSE

To view active pressure control parameters and/or set custom control parameters (see 3.2.2).

○ OPERATION

To view active control parameters and/or set custom control parameters, use [Settings], <Control>, Control Limits from the Main Run Screen. Alternatively [Limits] from the [Settings], <Control>, Pressure Control screen or from the **control mode** shortcut open this screen as well.

Three fields are available to edit: **Hold Limit**, **Stability Limit** (see Section 3.2.12) and **Jog Step** (see Section 3.2.19).

Edit the values of the desired parameters, noting the units of measure. [OK] to accept and return to the Main Run Screen. [Back] to return to <Control> with no changes. [Esc] or **ESC** to exit to the Main Run Screen with no changes.

To restore the default values of the three parameters use [Default Limits].

Note

Custom control parameters are range specific. Changes made in one range are stored for that range and are recalled when that range is returned to. Changes made in one range do not affect any other range.

4.7.8.3 Jog Step

○ PURPOSE

Adjust the nominal change in pressure caused by using the jog direct pressure control keys (**▲** and **▼**) or the knob (see Section 3.2.19).

○ OPERATION

[Settings], <Control>, Jog Step accesses the Jog Control Limits screen, with the Jog Step field active. Enter a new value in the currently active pressure units.

[OK] to accept the change and return to the Main Run Screen. [Back] to return to <Control> without making changes. [Esc] or **ESC** to exit to the Main Run Screen without making changes.

4.7.9 Remote

○ PURPOSE

To configure the PPC4E COM1, COM2 or IEEE-488 (GPIB) communication ports. To test COM1 and COM2 communications. To select remote programming communications format (see Section 3.2.22).

○ OPERATION

[Settings], <More >>>, <Remote> opens the Remote settings screen.

The following choices are available:

COM1: To view and edit COM1 settings (see Section 0).

COM2: To view and edit COM2 settings (see Section 0).

Command Format: To select remote programming command format (see Section 4.7.9.1)

USB: Indicates front USB port only, not selectable

IEEE-488: To view and edit IEEE-488 settings (see Section 4.7.9.2)

COM1 and COM2

The COMx ports can be set for specific communications settings. The settings are baud rate, parity, data bits and stop bits. The available options are:

Baud Rate: 1 200, 2 400, 4 800, 9 600, 19 200

Parity: None, Odd or Even

Data Bit: 7 or 8

Stop Bit: 1 or 2

The default is <2400, E, 7,1> for both COM1 and COM2.

Note

The PPC4E looks for an ASCII(13) (carriage return) to terminate a received command but responds with both an ASCII(13) (carriage return) and an ASCII(10) (line feed). There are no options.

See also Sections 5.2.1.1, 5.2.1.2 and 5.2.1.3.

4.7.9.1 Command Format

[Settings], <More >>>, <Remote>, Command Format opens the Command Format screen. The highlighted format is the currently active format.

[Settings], <More >>>, <Remote>, Command Format, Classic selects the Classic format for commands (see Section 5.3.1)

[Settings], <More >>>, <Remote>, Command Format, Enhanced selects the Enhanced format (see Section 5.3.2).

Selecting a format resets the IEEE-488 interface and puts it into an idle state.

See also Section 5.3.

4.7.9.2 IEEE-488

The IEEE-488 port's primary address can be set from 1 to 31 in this screen. The factory default value is 10. Secondary addressing is not used or supported. This address must not conflict with the address of any other device on the same IEEE-488 bus.

Note

The receiving terminating character must be a line feed and EOI. Carriage returns are ignored if received. The PPC4E sends a line feed and asserts the EOI line to terminate a reply. These settings are fixed to agree with IEEE Std. 488.2. If the address is changed, the IEEE interface resets (PON) and becomes idle.

4.7.10 Calibration

○ PURPOSE

To calibrate the PPC4E utility sensor, Hi and/or Lo RPTs and adjust the on-board barometer. This function is considered part of PPC4E maintenance and is therefore covered in the maintenance section of this manual (see Sections 6.2, 6.3).

○ OPERATION

See Sections 6.2, 6.3.

4.7.11 Uncertainty

○ PURPOSE

This function is considered part of PPC4E maintenance and is therefore covered in the maintenance section of this manual. See Section 6.2.7.1.

○ OPERATION

This function is considered part of PPC4E maintenance and is therefore covered in the maintenance section of this manual. See Section 6.2.7.1.

4.7.12 Internal

○ PURPOSE

To view, set, adjust, and maintain various aspects of PPC4E's internal operation (see Section 3.2.25).

○ OPERATION

[Settings], <More >>>, <Internal> opens the Internal settings screen.

4.7.12.1 ID

○ PURPOSE

To enter an alphanumeric identification (ID) for the PPC4E (see Section 3.2.25.1).

○ OPERATION

[Settings], <More >>>, <Internal>, ID opens the ID edit screen.

[OK] to accept and return to the Main Run Screen, [Back] to return to the ID screen without making changes, [Esc] or **ESC** to exit to the Main Run Screen without making changes.

4.7.12.2 Control Reference

○ PURPOSE

To specify whether the PPC4E should automatically determine whether a vacuum source or atmospheric pressure is connected to the EXHAUST port and to manually set the EXHAUST port condition (see Section 3.2.25.2).

○ OPERATION

[Settings], <More >>>, <Internal>, Control Reference opens the Control Reference edit screen.

Setting: Auto or Manual.

Control Reference: Vacuum or Atmosphere

Note

Control Reference is only editable if Setting is set to Manual.

[OK] to accept and return to the Main Run Screen, [Back] to return to the ID screen without making changes, [Esc] or **ESC** to exit to the Main Run Screen without making changes.

4.7.12.3 Purge

○ PURPOSE

To enable or disable the PPC4E Purge function (see Section 3.2.25.4).

○ OPERATION

[Settings], <More >>>, <Internal>, Purge opens the Purge screen. The current state of the Purge function is shown in gray. On to enable the Purge function. Select Off to disable.

[Back] to return to <Internal>, [Esc] to return to the Main Run Screen.

4.7.12.4 Event log

○ PURPOSE

To view and/or clear the PPC4E event log (see Section 3.2.25.5).

○ OPERATION

[Settings], <More >>>, <Internal>, Event Log opens the Event log screen if there are any entries in the log. If the word "None" is showing beside Event Log then there are no events (Pmax or Memory faults) in the log. If there are any log entries then the date and time of the last entry are shown.

In the Event Log screen the log entries may be scrolled through. When a given date and time are selected the specific entry is shown above the selection box. If the entry is a Pmax event then the specific RPT is indicated as well as the maximum recorded pressure in units of Pa.

[Clear Log] deletes and resets the entire log. [Back] returns to the <Internal> screen and [Esc] or **ESC** exits to the Main Run Screen.

4.7.12.5 TEST (-) Vent

○ PURPOSE

For models PPC4EX 100K and PPC4E 15K, causes the BGxxx RPT TEST (-) Vent valve to stay open or closed rather than open and close automatically (see Section 3.2.25.6).

Note

This menu selection is available only when the active RPT is a BG15K RPT (PPC4E 15K or PPC4EX 200K Lo RPT).

○ OPERATION

[Settings], <More >>>, <Internal>, TEST (-) Vent accesses the TEST (-) Vent screen. Selections are Operation and Status.

Operation: Auto or Manual

Status: Open or Closed

Automatic Operation is the default. Manual Operation allows the selection of always Open or always Closed. Status entry is only available if Manual operation is selected.

[Settings], <More >>>, <Internal> to view the settings of the TEST (-) Vent Valve

[OK] to accept and return to the Main Run Screen, [Back] to return to <Internal> without making changes, [Esc] or  to exit to the Main Run Screen without making changes.

Caution

If the PPC4E detects a condition in which it determines there could be a risk of overpressure to the RPT by opening the TEST (-) Vent valve when a Manual Open is requested, a message indicating a DP overpressure risk is displayed. If this message is displayed, return to normal operation, vent the PPC4E and try again.

5. Remote Operation

5.1 Overview

Most of the PPC4E front panel functions can also be executed by commands from a remote computer. The host computer can communicate to the PPC4E using the PPC4E RS232 (COM1) or IEEE-488 ports. The front panel USB port is used for firmware upgrades only (see Section 6.5). Remote communications via USB is not supported.

Before writing test code which makes use of PPC4E remote commands, familiarize yourself with its operating principles by reading Section 3 of this manual. Also refer to Sections 5.2.1.3 and Section 5.2.2.1 for testing RS232 and IEEE-488 commands.

5.2 Remote Interfacing

Sending a program message to the PPC4E places it into **Remote** mode. The remote indicator below the the display window lights when the PPC4E is in **Remote** mode. It will also flicker when a program message is received. The menus usually accessed from the front panel are locked out while in remote. **[ESC]** returns the PPC4E to local operation unless the **<REMOTE>** command, which locks out all keypad operation, was sent to the unit.

5.2.1 RS232 Interface

5.2.1.1 COM1

The PPC4E COM1 RS232 interface is located on the back of the unit. It is a 9-pin male DB-9F connector configured as a DCE device. Data is transmitted out of the unit using pin 2, and is received on pin 3. This allows a normal pin-to-pin DB-9M to DB-9F RS232 cable to be used to connect to a DTE host.

⚠ Caution

Handshaking is not required or supported. The COM1 receive buffer is 255 bytes deep. If the buffer overflows from sending too much data, the data will be lost. Because of this, it is essential to send a single program message at a time and it is essential to wait for the PPC4E to reply to a command before sending any other command.

Table 15. COM1 Pin Designations and Connections

PPC4E COM1 DB-9F PIN DESIGNATIONS		
PIN #	FUNCTION	DESCRIPTION
2	TxD	This pin transmits serial data from the PPC4E to the host.
3	RxD	This pin accepts serial data from the host computer.
5	Grn	This pin is the common return for the TxD and RxD signals.

IBM PC/XT DB-9F CONNECTIONS		IBM PC/XT DB-9M TO PPC4E DB9F CONNECTION	
DB-25M	DB-9F	DB-9M	DB-9F
2	3	3	3
3	2	2	2
7	5	5	5

5.2.1.2 COM2

The PPC4E COM2 RS232 interface is located on the back of the unit. COM2 can be used to allow the host computer to communicate with another device through the PPC4. This allows the user to use one host COM port to communicate with the PPC4E and an additional RS232 device. Refer to the “#” and “PASSTHRU” remote program commands for details.

COM2 is a 9-pin female DB-9F connector configured as a DTE device. Data is transmitted out of the unit using pin 3, and is received on pin 2. This allows a normal pin-to-pin DB-9M to DB-9F RS232 cable to be used to connect to a DCE device.

Handshaking is not required or supported.

Table 16. COM2 DB-9F Pin Designations

PIN #	FUNCTION	DESCRIPTION
2	RxD	This pin transmits serial data from the PPC4E to a device.
3	TxD	This pin accepts serial data from the external device.
4	DTR	This pin is Data Terminal Ready (DTR) (held at + 5 V).
5	Grn	This pin is the common return for the Tx and Rx signals.

5.2.1.3 RS232 Command Testing

An easy way to test RS232 communications independent of custom software is to use the Windows Hyperterminal found in the accessories group under All Programs (See Figure 11)

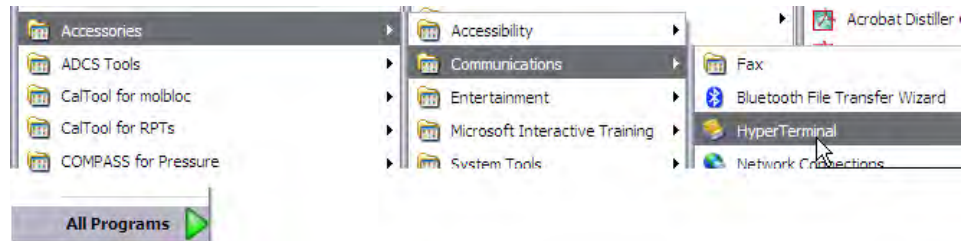

Figure 11. Windows selection of Hyperterminal

Hyperterminal must be configured to communicate with the PPC4E using the RS232 COM1 communication settings accessed through the PPC4E front panel (see Section 0 for the Advanced Interface and Section **Error! Reference source not found.** for the Basic Interface). Refer to the following series of steps to configure Hyperterminal assuming that the PPC4E is connected to COM4 of a host PC using a baud rate of 2400, 7 data bits, event parity and 1 stop bit.

- 1 Figure 12 is displayed when Hyperterminal is run for the first time. Enter an easily identifiable name to reference the communications session. Future Hyperterminal sessions are initiated by selecting the named session.

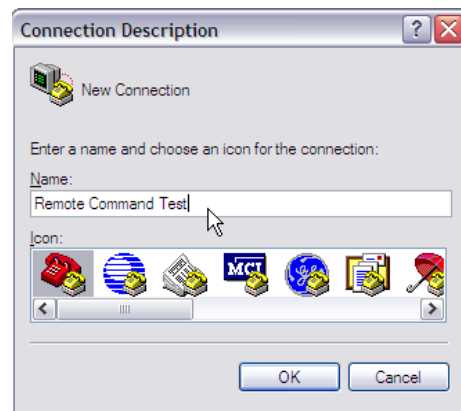
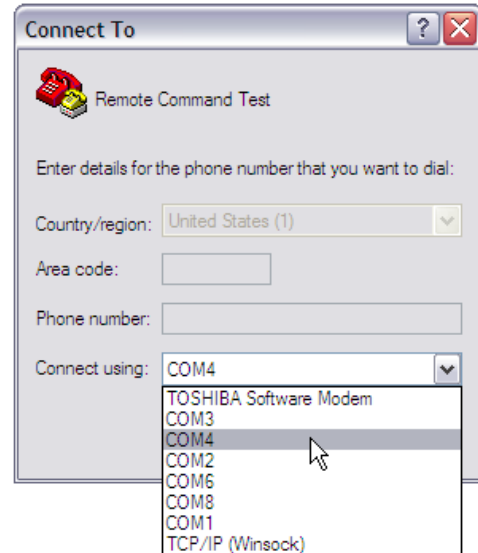
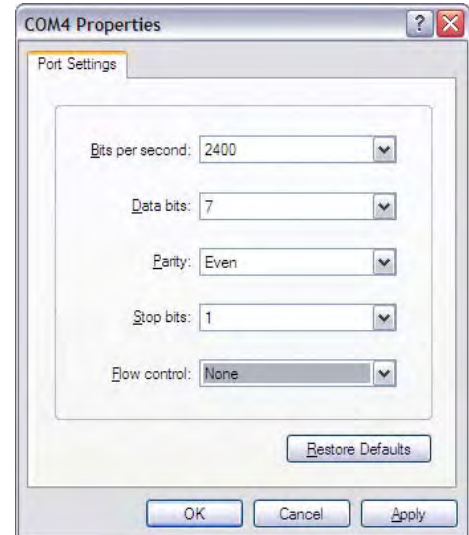

Figure 12. Hyperterminal Initial Display

- ② The next dialog defines the RS232 port to use for communication. Select the host PC's COM port that will be connected to the PPC4. Do not confuse this selection with the COM1 and COM2 ports on the back of the PPC4.



- ③ After the COM port selection, the RS232 settings of the PPC4E must be defined. The specific PPC4E settings are accessed through the PPC4E front panel. RS232 handshaking is not supported by the PPC4E, therefore None is the appropriate selection for Flow Control.



- ④ The focus will return to the main Hyperterminal program after the COM port properties are defined. At this point, the last steps are to define command and response terminators. Access the [File] menu and select [Properties]

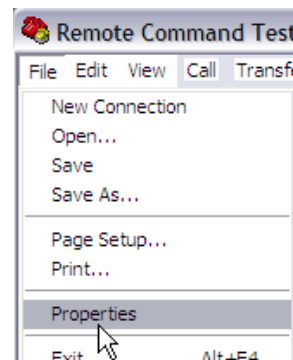

- 5 Within the Properties dialog, press the ASCII setup button.

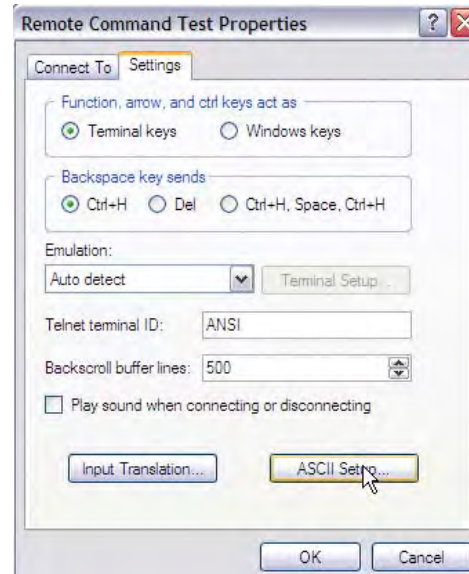

- 6 Make the selections listed in the figure below. These selections enable a carriage return (ASCII 13) and line feed (ASCII 10) to be appended to the end of the commands to the PPC4E and the corresponding responses. Press [OK] after the edits are complete.

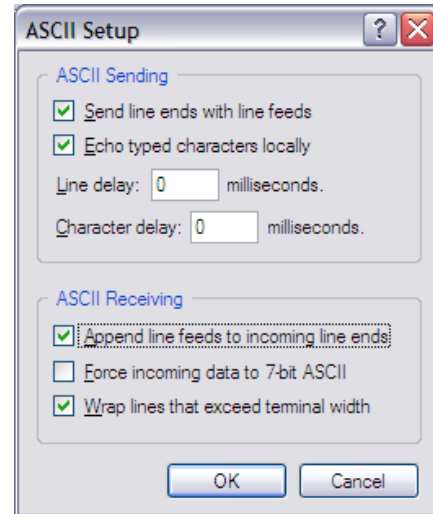
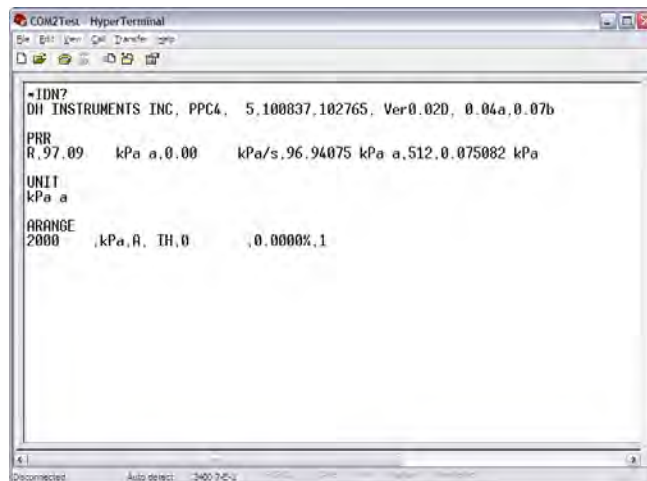

Figure 13. Hyperterminal ASCII Setup

- 7 At this point it is best to save and close the current Hyperterminal session. Open Hyperterminal a second time, choose [Cancel] on the opening dialog, then use the [File][Open] menu to select the file just created “Remote Command testing.



5.2.2 IEEE-488

The PPC4E IEEE-488 interface is located on the back of the unit. The physical and electrical interface conforms to IEEE Std 488.1-1987 Subset E2 and IEEE Std. 488.2-1992. Do not attempt to communicate with the IEEE-488 interface while using the COM1 or USB interfaces. The IEEE-488 receive buffer is 250 bytes deep. If the buffer overflows, the PPC4E will hold off release of the NRFD handshake line until it can service and empty the receive buffer. This keeps the buffer from overflowing. It is recommended that you use the query form for all remote commands and wait for a reply to each command to ensure proper operation and order of command execution. Not reading a command response will cause the PPC4E to respond improperly to future remote commands.

5.2.2.1 IEEE-488 Remote Command testing

Verify IEEE-488 communication with the PPC4E by using a communication tool provided by the PC's IEEE-488 interface manufacturer. The following sequence describes the steps to setup and communicate with the PPC4E by using a NI (National Instruments) IEEE-488 adapter. Different versions of the NI adapter and cards from other manufacturers will have slightly different steps and labeling.

- ❶ Install the IEEE-488 interface into the host PC and verify that the adapter is properly setup.
- ❷ Connect the PPC4E to the host PC by using an IEEE-488 communications cable.
- ❸ Launch the NI Measurement and Automation Explorer. Locate the option to scan for instruments. The PPC4E should be detected at the addressed defined in [Settings], <Interface>, IEEE-488.

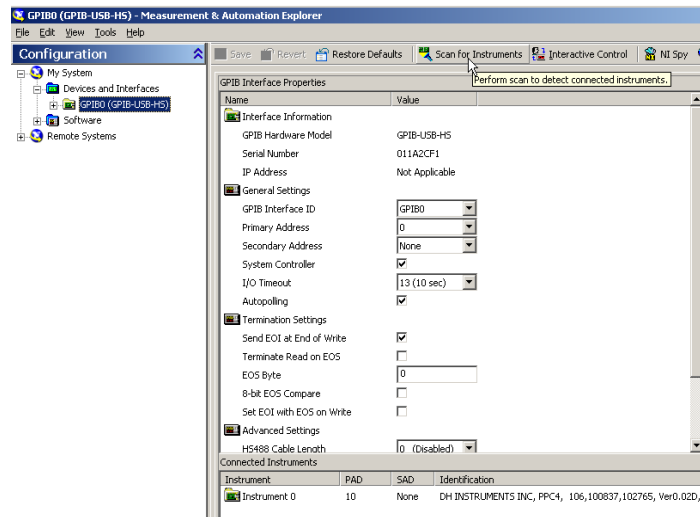

- ❹ Select the Communicate with Instrument option to invoke a dialog to enter discrete commands to the PPC4. No other specific PPC4E IEEE-488 setup is required.

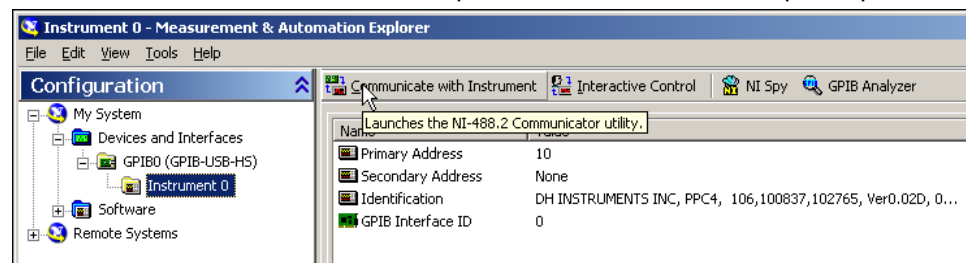

- 5 Enter a PPC4E command into the Send String field and choose [Query] or [Write] based on the command entered and the PPC4E command format. While communicating in Enhanced mode with IEEE-488, no response is provided by the PPC4E unless a “?” is included with the command. Attempting to read a response when a “?” is not included will yield an interface error. If a “?” is included and a response is not read, future commands will not respond properly. For this reason, make sure to use the [Read] button if [Write] was used to send a query form command

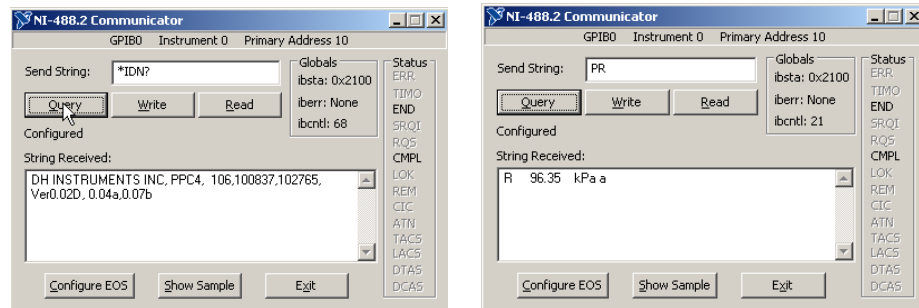

5.3 Programming Formats

PPC4E supports two program message formats, “Classic” and “Enhanced”. The user must select which format to use. Selection can be accomplished from the front panel (see Section 4.7.9.1) or remotely using the “MSGFMT” program message (see Section 5.4.4).

The main difference between the two formats is that when using the IEEE-488 interface, a “?” must be included in an enhanced command for there to be a response from the PPC4. In all other cases (classic or enhanced), every command has a response. In addition, the enhanced message format supports IEEE Std. 488.2 syntax, format and status reporting.

The default is the classic format to allow downward compatibility with existing host software.

In either format, it is recommended that you start out a command sequence with the “*CLS” command, which clears all of the communication and error queues. The basic commands are similar for both the classic and enhanced formats, but the usage, syntax, format and status reporting are different.

Note

The PPC4E program message set is compatible with PPC3 and PPC4 program message sets. In some cases additional arguments are available at the end of PPC4E commands that are not available in PPC3 commands. However the command function is not altered.

5.3.1 Classic Program Message Format

Each program message sent is also a query. Only one program message can be sent to the PPC4E at time. After sending any program message, the PPC4E must reply before another program message can be sent. The reply will contain data, or a numeric error message if the program message was invalid. The reply must be received before issuing another program message to the PPC4. This insures that the PPC4E has completed the program message. Most remote program messages will return a reply within 500 ms except:

“PR”, “PRR”, “SR”, “ATM”, “RATE”: Up to 2.0 seconds to allow a new measurement.

“RPT”, “ARANGE”: Up to 10 seconds

The syntax and format used for each program message in the classic mode is listed next to the keyword ‘Classic.’ in each program message summary in Section 5.4.4.

5.3.2 Enhanced Program Message Format

The enhanced program message format uses the IEEE Std. 488.2 format, syntax and status reporting. Errors are reported using the IEEE Std. 488.2 status reporting model. If an error is reported, the error is put into an Error Queue and the “ERR?” query program message can be used to get a text description of the most recent error. If you are using the IEEE-488 port, the service request line can be setup to be asserted if this occurs (see Section 5.5.2). In the enhanced format, there are two possible program message types for every program message. Each of these two types starts with the same basic text referred to as the program message header. The two types are COMMAND type and QUERY type commands.

5.3.2.1 Using Command Type Commands

Note

Enhanced format commands DO NOT reply when using the IEEE-488 interface unless a “?” is included in the command. There will be no response from PPC4E to non-query (no “?”) commands. Remote software can time-out waiting for a response from PPC4. However, in RS232 communications, there is always a response and the response MUST be read prior to issuing another command.

The COMMAND type of program message executes a process and can additionally send data to the PPC4E in the form of comma delimited arguments. This data is usually a setting of some sort that is stored in the PPC4. If data is specified, it must be preceded by at least one white space from the program message header and be within the range and format described in the program message description. The keyword “**Command:**” appears to the left of the required syntax in each program message description in Section 5.4.4 .

If you are using the IEEE-488 port, the Command type does not generate a reply unless you place a query operator “?” immediately after the command. You also may send multiple program messages at once by separating each program message with a semicolon. The commands are queued and executed in as received order after the entire message stream has been received, so care in determining order of execution is needed.

If you are using the RS232 port COM1, the Command type will always generate a reply so you **must** wait for a reply before issuing another program message. Because of this, you can only send one Command program message at a time while using the COM1 port.

Examples:

- **IEEE-488 enhanced mode command series using query operator:**
 - “*CLS?” (Clear the error queue. Wait for reply.)
 - “UNIT? KPA” (Generates a reply. User must wait for reply before continuing.)
 - “MMODE? A” (Generates a reply. User must wait for reply before continuing.)
 - “PS? 100” (Generates a reply. User must wait for reply before continuing.)
- **IEEE-488 enhanced mode commands without query operator:**
 - “*CLS” (Clear the error queue. No reply.)
 - “UNIT KPA” (No reply)
 - “MMODE A” (No reply)
 - “PS 100” (No reply)
 - “ERR?” (Wait for reply. User should use “ERR?” query following a series of non query commands to check for errors that may have occurred.)

- **IEEE-488 enhanced mode multiple commands without query operator:**
 - “*CLS” (Clear the error queue. No reply)
 - “UNIT KPA;MMODE A;PS 100” (Three commands at once. No reply)
 - “ERR?” (Wait for reply. User should use “ERR?” query following a series of non query commands to check for errors that may have occurred)
- **COM1 enhanced mode command:**
 - “*CLS” or “*CLS?” (Clear the error queue. Wait for reply.)
 - “UNIT KPA” or “UNIT? KPA” (Generates a reply. User must wait for reply before continuing.)
 - “MMODE A” or “MMODE? A” (Generates a reply. User must wait for reply before continuing.)
 - “PS 100” or “PS? 100” (Generates a reply. User must wait for reply before continuing.)

5.3.2.2 Using Query Type Commands

The QUERY type of program message just requests data from the PPC4. Placing the query operator “?” immediately after the command creates a query. Software **must** wait for a reply with a query. If any type of program message is sent to the PPC4E after a query before receiving a reply, the program message will be discarded and an error will be generated. Errors are reporting using the IEEE Std. 488.2 status reporting model. A Query program message always ends with a question mark. Most queries will return a reply within 200 ms except:

“PR?”, “PRR?”, “SR?”, “ATM?”, “RATE?”: Up to 2.0 seconds.
 “RPT”, “ARANGE”: Up to 10 seconds

The syntax for using a QUERY program message is listed next to the keyword “Query:” in each program message summary in Section 5.4.4 .

5.4 Commands

5.4.1 Programming Messages

Table 17. Program Message List

#	Send a command string out of the PPC4E COM2 port.
ABORT	Stop pressure generation.
ARANGE	Read or set a new AutoRange to use.
ATM	Read the current atmospheric pressure (on-board barometer).
AUTOPURGE	Read or set the status of the automatic purge function.
AUTOVAC	Read or set the status of the control reference (EXHAUST port).
CALAMB	Read or set the on-board barometer calibration
COM1	Read or set the configuration of the COM1 port.
COM2	Read or set the configuration of the COM2 port.
DATE	Read or set the current date.
DF	Decrease the pressure quickly (fast).
DISPUNC	Enable or disable display of uncertainty and select the display mode
DP	Decrease the pressure a given amount.
DRV	Read or set the status of the external valve drivers.
DS	Decrease pressure slowly.
ERR	Read the last error message.
GPIB	Read or set the GPIB interface address.
HEAD	Read or set the fluid head settings.
HS	Read or set the current control hold limit in pressure.
HS%	Read or set the current control hold limit in percent span of the active range.
ID	Read or set the PPC4E alphanumeric asset ID tag.
IF	Increase the pressure quickly (fast).
IP	Slowly increase the pressure a given amount.
IS	Increase the pressure slowly.
Ln	Gets or sets the command interpreter mode.
LAN	Read or set the optional network interface settings.
LL	Read or set the lower limit for the current range (negative gauge mode only).
LOCAL	Return control to the PPC4E front panel.
MEM	Read the power-up memory test status.
MMODE	Read or change the active measurement mode.
MODE	Read or set the current pressure control mode.
MSGFMT	Read or set the type of program message format to use.
NVENT	Read or set the status of the lo vent valve (Gxxx or BGxxx RPT only).
PASSTHRU	Send a command string out of the PPC4E COM2 port.
PCAL:IH	Read or set the user Lo RPT calibration information.
PCAL:IL	Read or set the user Hi RPT calibration information.
PR	Read the next PPC4E pressure.
PRR	Read the next available pressure, rate, on-board barometer reading, control status, and the QRPT uncertainty.
PS	Set a new target pressure and start automated pressure control.
PSF	Set a new target pressure and use only the fast speed to reach the target.
PSS	Set a new target pressure and use only the slow speed to reach the target.
QPRR	Quickly read the last known pressure, rate, on-board barometer reading, control status and QRPT uncertainty.

RANGE	Read or set and RPT or utility sensor default range (PPC4E command).
RATE	Read the next available rate of change of pressure.
READYCK	Read or set a flag that is cleared by a <i>Not Ready</i> condition.
REMOTE	Enable remote local lockout operation.
RES	Read or set the pressure display resolution for the current transducer and range.
RESET	Reset the PPC4E to the default user parameters.
RETURN	Start a new automated pressure control set using the current target value.
RPT	Read the available RPT data or initiate the RPT search process.
SCRSAV	Read or set the front panel display screen saver activation time & type.
SN	Read the serial number of the PPC4.
SR	Read the next available pressure status (<i>Ready/Not Ready</i>).
SS	Read or set the stability required for a <i>Ready</i> condition.
SS%	Read or set the stability required for a <i>Ready</i> condition (% span/ s).
STAT	Read the pressure control status.
TIME	Read or set the current time of day.
TIMEFMT	Read or set the clock time format.
TP	Read the current target pressure.
UCOEF	Convert a pressure in Pascal to pressure in the current units.
UDU	Read or set the user defined pressure unit.
UL	Read or set the upper limit for the current range.
UNIT	Read or set the pressure unit of measure for the current range.
VAC	Read or set the exhaust reference status flag.
VENT	Read, execute or abort a vent process.
VER	Read the PPC4E software version.
ZOFFSET_n	Read or set the AutoZero P_{offset} for the specified RPT.

5.4.2 Error Messages

Table 18. Error #s and Descriptions

REPLY	DESCRIPTION
ERR# 0	"OK"
ERR# 2	"Text argument is too long"
ERR# 3	"Arguments cannot be 0"
ERR# 6	"Numeric argument missing or out of range"
ERR# 7	"Missing or improper command argument(s)"
ERR# 9	"Unknown command"
ERR# 10	"Missing or invalid command suffix"
ERR# 11	"Command missing argument"
ERR# 12	"System overpressured" or "overpressure may result"
ERR# 13	"Text queue overflow"
ERR# 14	"User unit not defined"
ERR# 16	"Generation failure"
ERR# 18	"Command not yet available"
ERR# 19	"Not available with absolute units"
ERR# 20	"Not available with gauge device"
ERR# 21	"User device not defined"
ERR# 22	"Pressure is not stable"
ERR# 23	"Option not available or installed"
ERR# 24	"Unit must be vented"
ERR# 25	"Transducer out of calibration"
ERR# 26	"COM port failed to initialize"
ERR# 27	"Internal device failure"
ERR# 28	"Device failure"
ERR# 29	"Device not available"
ERR# 30	"Must be on range IH"
ERR# 31	"Exceeds upper or lower limit"
ERR# 32	"Not stable enough"
ERR# 37	"Data table is full"
ERR# 38	"Selected range is not available"
ERR# 39	"Data verify error"
ERR# 45	"Argument not allowed"
ERR #46	"Argument cannot be negative"
ERR #52	"Command obsolete"
ERR# 53	"Not Available"

5.4.3 Program Message Description Overview

Each program message description is separated into the following sections:

Purpose	A brief description of the programs message's function.
Command	This is the Enhanced program message syntax to send data to the PPC4E or to execute a PPC4E function. The PPC4E must be set to use the enhanced format (see Section 3.5.2.3) to use the syntax and style shown. It may be sent alone, or followed by at least one white space and additional argument(s) to show that arguments can be passed. If there are multiple arguments, then commas must separate them. If you are using the IEEE-488 port, multiple command type program messages can be sent in one message if you separate them with a semicolon. There will be no reply from the PPC4E using the IEEE-488 port unless the command is immediately followed by the query operator "?". If you are using the COM1 port, the PPC1 will reply and you must wait for this reply. If this field is not listed in the program message description, then the Command type is not supported when using the Enhanced format.
Query	This is the Enhanced program message syntax to request data from the PPC4. The PPC4E must be set to use the enhanced format (see Section 3.5.2.3). The PPC4E will always reply to a query. You must wait for this reply before issuing another program message. If this field (Query) is not listed in the program message description, then the Query type for the program message is not supported when using the Enhanced format.
Classic	This is the Classic program message syntax to send data to the PPC4E, to execute a PPC4E function, or to query for data. The PPC4E must be set to use the classic format (see Section 3.5.2.3). The command may be followed by a '(=)' and additional argument characters to show that argument(s) can be passed. If there are multiple arguments, then commas must separate them. The PPC4E will always reply to a Classic program message. You must wait for this reply before issuing another program message. If this field is not listed in the program message description, then it is not supported when using the classic format.
Arguments	If the program message can be used to set data inside the PPC4E, then this section describes the arguments and their limits. Command arguments that reference the terms "IH" and "IL" refer to the PPC4E Hi and Lo RPT respectively.
Default	If the program message can be used to set data inside the PPC4E, then this line shows (using the enhanced format) the default setting from the factory.
Remarks	This field has the details and remarks about the command.
Example	Examples are given for the enhanced and classic methods. Enhanced: An example of the use of an enhanced format program message to be sent to the PPC4E is shown. The message sent to the PPC4E appears after the "Cmd sent:" label. If only a Query type exists, the "Query sent:" label is shown instead. Directly under this label, "Query reply" shows a typical reply to a query type. "Reply:" shows that a query format does not exist. It may have a short description next to it. Classic: An example of the use of a classic program message to be sent to the PPC4E is shown. The command sent to the PPC4E appears after the "Cmd sent:" label. The "Reply" label shows a typical reply to the "Sent" example. It may have a short description next to it.
Errors	If the program message can report an argument error, the types of errors are listed. If using the classic format or the COM1 port, the error message is replied after receiving the program message. If using the enhanced format via the IEEE-488 port, the error condition is handled by the status reporting model which stores the errors in an Error Queue and can be programmed to assert the IEEE-488 SRQ line to signal an error has occurred. In either case, the "ERR" or "ERR?" program message can be used to retrieve a text description of the error.
See Also	Indicates related command ("----") and refers to manual sections giving detail on PPC4E operation corresponding to the program message.

5.4.4 Program Message Descriptions

#	
Purpose	To allow the host PC to communicate with a device connected to the PPC4E COM2 port. The preferred method is to use the "PASSTHRU" program message.
Classic	"#xx"
Arguments	xx: The string to send out of the COM2 port. It must be less than 40 characters long.
Remarks	<p>The PPC4E COM2 port can be used to communicate to another RS232 device (such as another PPC4). This allows the user to use one COM port or IEEE-488 port on the host computer to communicate with the PPC4E and another device. A carriage return and a line feed (<CR><LF>) are added to the string.</p> <p>After this program message is issued, the PPC4E will reply back the first string received by the PPC4E COM2 port that is terminated with a carriage return. Line feeds are discarded.</p> <p>This will discontinue when the next program message is sent to the PPC4.</p> <p>There is no other reply from this program message. Prior to using this program message, you must ensure that the PPC4E COM2 port is correctly set up to communicate with the device on COM2. Refer to the "COM2=" program message.</p>
Example (classic)	<p>Sent: "#VER"</p> <p>Reply: "FLUKE PPC4E us A1000/A0015 Ver2.00 "</p> <p>This example assumes that a second PPC4E's COM1 port is connected to the PPC4E COM2 port. This example gets the version of the second PPC4.</p>
See Also	"PASSTHRU", "COM2" 3.2.22

ABORT	
Purpose	Stops active pressure generation/control. All control valves are closed. The exhaust and transducer isolation valves are not affected.
Command Classic	"ABORT" "ABORT"
Remarks	This program message has no effect if the PPC4E is not using automated pressure control. When using automated pressure control, it aborts the control. This command is recommended to idle the PPC4E before setting a new target pressure.
Example (enhanced)	<p>Cmd sent: "ABORT"</p> <p>Reply: "ABORT" (no reply if IEEE-488)</p>
Example (enhanced)	<p>Cmd sent: "ABORT?"</p> <p>Reply: "ABORT"</p>
Example (classic)	<p>Sent: "ABORT"</p> <p>Reply: "ABORT"</p>
See Also	3.2.11, 3.2.2

ARANGE	
Purpose	Read existing AutoRange range or create a new AutoRange range.
Command Query	"ARANGE <i>Range, unit, mode</i> (<i>,RptLabel</i>)" "ARANGE?"
Classic	"ARANGE= <i>Range, units, mode</i> (<i>,RptLabel</i>)" "ARANGE"
Arguments	<p><i>Range</i> The AutoRange maximum pressure. Cannot be negative. <i>Unit:</i> The unit of measure of the <i>Range</i> argument. <i>Mode:</i> The measurement mode of the <i>Range</i> argument: "A" for absolute "G" for gauge "N" for negative gauge</p> <p style="text-align: center;">Note</p> <p style="text-align: center;">Measured pressure values are returned with "g" to identify measurement mode for both gauge and negative gauge measurement modes.</p> <p><i>RptLabel:</i> One of the RPTs that is available. (optional) "IH": Hi RPT "IL": Lo RPT</p>
Remarks	<p>The ARANGE command is used to define a PPC4E range by specifying a desired unit of measure, measurement mode and maximum pressure, and have the PPC4E pick the best available RPT and make operational adjustments to optimize that range. Available RPTs may be determined by the use of the "RPT" command or [RPT] function key.</p> <p>The reply indicates the current range data, including the <i>RptLabel</i> used for the range.</p> <p>If a water column unit (inH2O, mH2O, mmH2O) is specified for the pressure unit of measure, the temperature reference can be given after the unit text. For example, "inH2O4", "inH2O20" or "inH2O60" corresponds to inH2O at 4 °C, 20 °C or 60 °F. If no temperature is specified, a default of 20 °C is assumed. There is no indication of the temperature reference in the reply.</p>
Example (enhanced)	Cmd sent: "ARANGE?" (read the current range in the current units) Query reply: "100.00, psi, A, IH"
Example (classic)	Cmd sent: "ARANGE" (read the current range in the current units) Query reply: "100.00, psi, A, IH"
Example (enhanced)	Cmd sent: "ARANGE? 250, inWa4, G (range of 250 inWa @ 4 °C in gauge mode) Query reply: "250.000 inWa, G, IH" (Hi RPT)
Example (classic)	Cmd sent: "ARANGE=250, kPa, G (set a range of 250 kPa in gauge mode) Query reply: "250.00 kPa, G, IL" (Lo RPT)
Errors	<p>ERR# 6: "Range" maximum pressure exceeds available RPTs or is negative. ERR# 19: Cannot Range to '0' with absolute units. ERR# 20: Cannot Range to '0' with gauge units. ERR# 29: Correct type of RPT for the selected "Mode" is not available.</p>
See Also	"RPT", "RANGE" Error! Reference source not found. 3.2.5, 3.2.6, 3.2.10

ATM	
Purpose	Reads the next measured pressure from PPC4E's on-board barometer.
Query Classic	"ATM?" "ATM"
Remarks	The atmospheric pressure as measured by the PPC4E on-board barometer is returned in the current pressure units (always absolute). This measurement is followed by the units text.
Example (enhanced)	Query sent: "ATM?" Query reply: "97.12348 kPaa"
Example (classic)	Sent: "ATM" Reply: "97.12384 kPaa"
See Also	3.2.25.3

AUTOPURGE	
Purpose	Read or set the status of the automatic purge function.
Command Query	"AUTOPURGE n" "AUTOPURGE?"
Classic	"AUTOPURGE=n" "AUTOPURGE"
Default	"AUTOPURGE 0"
Arguments	<i>n</i> : '0' To disable AUTO mode. '1' To enable AUTO mode.
Remarks	The PPC4E can automatically control the external SPLT functions to purge the test system before running a test, if desired.
Example (enhanced)	Cmd sent: "AUTOPURGE 1" Query reply: "1" (No reply if IEEE-488)
Example (enhanced)	Cmd sent: "AUTOPURGE 1" Query reply: "1"
Example (classic)	Sent: "AUTOPURGE=1" Query reply: "AUTOPURGE=0"
Errors	ERR# 6: The argument was other than a '0' or a '1'.
See	3.2.16, 3.2.25.4

AUTOVAC	
Purpose	Read or set the status of the automated Control Ref determination mode.
Command Query	"AUTOVAC n" "AUTOVAC?"
Classic	"AUTOVAC=n" "AUTOVAC"
Default	"AUTOVAC 1"
Arguments	<i>n</i> : '0' To disable AUTO mode. ("VAC" cmd determines status) '1' To enable AUTO mode. This will override the manual selection.
Remarks	At low pressures, PPC4E control is affected by whether the EXHAUST port is open to atmosphere or connected to vacuum. The PPC4E has an internal sensor that can be used to automatically determine if the EXHAUST port is open to atmosphere or to a vacuum. You can disable it to manually override it. It is recommended to use the "VAC" command to disable this feature instead of the "AUTOVAC=0" command, as you can also specify vacuum or atmospheric reference at the same time with the VAC command.
Example (enhanced)	Cmd sent: "AUTOVAC 1" Query reply: "1" (No reply if IEEE-488)
Example (enhanced)	Cmd sent: "AUTOVAC 1" Query reply: "1"
Example (classic)	Sent: "AUTOVAC=0" Query reply: "AUTOVAC=0"
Errors	ERR# 6: The argument was other than a '0' or a '1'.
See Also	"VAC" 3.2.25.2

CALAMB	
Purpose	Read or set the on-board barometer calibration coefficients.
Command Query	"CALAMB <i>adder, mult, CalDate</i> " "CALAMB?"
Classic	"CALAMB= <i>adder, mult, CalDate</i> " "CALAMB"
Defaults	"CALAMB = 0.0, 1.0, 19800101"
Arguments	<i>Adder</i> : The Barometer calibration adder (PA).In Pascal. <i>Mult</i> : The Barometer calibration multiplier (PM) from 0.1 to 100. <i>CalDate</i> : The date of the calibration in the format "YYYYMMDD"
Remarks	The barometer calibration information can be accessed with this program message. Using this program message overwrites the current calibration coefficients, so caution must be used. Changes made take effect immediately.
Example (enhanced)	Cmd sent: "CALAMB? 2.1, 1.000021, 20011201" Query reply: " 2.10, 1.000021, 20011201" (No reply if IEEE-488)
Example (classic)	Sent: "CALAMB=2.1, 1.000021, 20011201" Reply: " 2.1, 1.000021, 20011201"
Errors	ERR# 6: One of the arguments is out of range.
See Also	3.2.25.3, 6.3

COM1	
Purpose	Read or set the RS232 settings for the COM1 port.
Command Query	"COM1 <i>baud, parity, data, stop</i> " "COM1?"
Classic	"COM1= <i>baud, parity, data, stop</i> " "COM1"
Arguments	<i>Baud</i> : The baud rate. This may be '2400','4800', '9600' or '19200'. <i>Parity</i> : The data parity. This may be 'O' for odd, 'E' for even, or 'N' for none. <i>Data</i> : The number of data bits. This may be '7' or '8'. <i>Stop</i> : The number of stop bits. This may be '1' or '2'.
Defaults	"COM1 2400,E,7,1"
Remarks	The COM1 port is used to communicate to the PPC4. When the COM1 port configuration of the PPC4E is changed, the program message reply (COM1 use only) is sent at the old COM1 settings, but all subsequent communications are accomplished at the new COM1 settings. A 200ms or longer delay after receiving the reply to this command will ensure that the PPC4E has changed the COM port settings and is ready for communications at the new settings.
Example (enhanced)	Cmd sent: "COM1 9600,N,8,1" Query reply: "9600,N,8,1" (No reply if IEEE-488)
Example (enhanced)	Cmd sent: "COM1? 9600,N,8,1" Query reply: "9600,N,8,1"
Example (classic)	Sent: "COM1=9600,N,8,1" Reply: "9600,N,8,1"
Errors	ERR# 7: Missing or improper program message argument(s).
See Also	"PASSTHRU" 3.2.22

COM2	
Purpose	Read or set the RS232 settings for the COM2 port.
Command Query	"COM2 <i>baud,parity,data,stop</i> " "COM2?"
Classic	"COM2= <i>baud,parity,data,stop</i> " "COM2"
Arguments	<i>baud</i> : The baud rate. This may be '2400', '4800', '9600' or '19200'. <i>parity</i> : The data parity. This may be 'O' for odd, 'E' for even, or 'N' for none. <i>Data</i> : The number of data bits. This may be '7' or '8'. <i>stop</i> : The number of stop bits. This may be '1' or '2'.
Defaults	"COM2 2400,E,7,1"
Remarks	The COM2 port can be used to allow the host computer to communicate through the PPC4E to an additional device connected to COM2. This can be useful if the host computer does not have 2 serial ports available.
Example (enhanced)	Cmd sent: "COM2 9600,N,8,1" Query reply: "9600,N,8,1" (No reply if IEEE-488)
Example (enhanced)	Cmd sent: "COM2? 9600,N,8,1" Query reply: "9600,N,8,1"
Example (classic)	Sent: "COM2=9600,N,8,1" Reply: "9600,N,8,1"
Errors	ERR# 7: Missing or improper program message argument(s).
See Also	"#", "PASSTHRU" 3.2.22

DATE	
Purpose	Read or set the PPC4E date.
Command Query	"DATE <i>date</i> " "DATE?"
Classic	"DATE= <i>date</i> " "DATE"
Arguments	<i>date</i> : The date in the numerical only format YYYYMMDD.
Remarks	The PPC4E has an internal real time calendar clock. It is used for date stamping calibrations. The reply is always in the YYYYMMDD format.
Example (enhanced)	Cmd sent: "DATE 20030115" Query reply: "20030105" (No reply if IEEE-488)
Example (enhanced)	Cmd sent: "DATE? 20030105" Query reply: "20020105"
Errors	ERR# 7: Missing or improper program message argument(s).
See Also	"TIME" 3.2.24.3

DF	
Purpose	Decrease the pressure quickly (fast).
Command	"DF <i>n</i> "
Classic	"DF= <i>n</i> "
Arguments	'0' Closes the fast down valve. '1' Opens the fast down valve.
Remarks	Opening the fast down valve causes the pressure to decrease quickly.
Example (enhanced)	Cmd sent: "DF 1" Reply: "1" (no reply if IEEE-488)
Example (enhanced)	Cmd sent: "DF? 1" Reply: "1"
Example (classic)	Sent: "DF=1" Reply: "DF=1"
Errors	ERR# 6: The <i>n</i> argument is a '0' or a '1'.
See Also	"IF", "DS", "IS", "IP", "DP", Figure 17

DISPUNCn	
Purpose	Read or set the RPT uncertainty display mode.
Command	"DISPUNCn Enable, Mode"
Query	"DISPUNCn?"
Classic	"DISPUNCn=Enable, Mode" "DISPUNCn"
Defaults	"DISPUNCn = 1, 1"
Suffix	<i>n</i> : '1' to access the IH RPT settings '2' to access the IL RPT settings
Arguments	<i>Enable</i> : '0' or '1' to disable or enable the uncertainty display. <i>Mode</i> : '0' or '1' to display measured or delivered pressure uncertainty (optional).
Remarks	The <i>Mode</i> argument is optional, so that the display can be enabled or disabled without changing the mode.
Example (enhanced)	Cmd sent: "DISPUNC 1, 1" Query reply: "1, 1" (No reply if IEEE-488)
Example (classic)	Sent: "DISPUNC=0" Reply: "0, 1"
Errors	ERR# 6: One of the arguments is out of range.
See Also	3.2.27

DP	
Purpose	Decrease the pressure slowly a given amount using the slow speed.
Command	"DP n"
Classic	"DP=n"
Arguments	<i>n</i> : The decrease in pressure desired (current pressure units). This can be from 0 to 2 % FS of the active range.
Remarks	The slow speed will be used for a calculated amount of time (up to 5 seconds) to create the desired change. The PPC4E will not attempt to control the pressure to a target, so the change in pressure will be approximate. This is the equivalent of using  .
Example (enhanced)	Cmd sent: "DP 2" Reply: "2.000 kPa" (no reply if IEEE-488)
Example (enhanced)	Cmd sent: "DP? 2" Reply: "2.000 kPa"
Example (classic)	Sent: "DP=2" Reply: "2.000 kPa"
Errors	ERR# 6: The <i>n</i> argument is not within given limits.
See Also	"IP", "DS", "IS", "DF", "IF" 3.2.1

DRVn	
Purpose	Read or set the status of external electrical drivers.
Command	"DRVn x"
Query	"DRVn?"
Classic	"DRVn=x" "DRVn"
Arguments	<i>n</i> : The driver to operate. This can be from 1 to 8. <i>x</i> : The state to change the driver to; '0' to de-activate it, '1' to activate it.
Remarks	The PPC4E control has eight optional external drivers. Driver is used by the optional Purge function.
Example (enhanced)	Cmd sent: "DRV1 1" Query reply: "1" (No reply if IEEE-488)
Example (enhanced)	Cmd sent: "DRV2? 1" Query reply: "1"
Example (classic)	Sent: "DRV1=1" Reply: "DRV1=1"
Errors	ERR# 6: The <i>n</i> or <i>x</i> arguments are not within given limits.
See Also	3.2.21

DS	
Purpose	Decrease the pressure slowly.

Command	"DS <i>n</i> "
Classic	"DS= <i>n</i> "
Arguments	<i>n</i> : '0' Closes the slow down valve. '1' Opens the slow down valve.
Remarks	Opening the slow down valve causes the pressure to decrease slowly.
Example (Enhanced)	Cmd sent: "DS 1" Reply: "1" (no reply if IEEE-488)
Example (Enhanced)	Cmd sent: "DS? 1" Reply: "1"
Example (Classic)	Sent: "DS=1" Reply: "DS=1"
Errors	ERR# 6: The <i>n</i> argument is a '0' or a '1'.
See Also	"IS", "DF", "IF", "DP", "IP" Figure 17

ERR	
Purpose	Read the new available error message from the Error Queue.
Query	"ERR?"
Classic	"ERR"
Remarks	This program message obtains additional details about an error that has occurred. If the user receives an "ERR# <i>nn</i> " reply, or the enhanced mode is enabled using the IEEE-488 interface and an error has been detected, the error is put into a FIFO Error Queue. The "ERR" program message pulls and replies the oldest error message available. "OK" is replied if there are no error messages left.
Example (enhanced):	Query sent: "ERR?" Query reply: "Numeric argument missing or out of range"
Example (classic)	Sent: "ERR" Reply: "Numeric argument missing or out of range"
See Also	5.4.2

GPIB	
Purpose	Read or set the GPIB interface address.
Command Query	"GPIB <i>addr</i> " "GPIB?"
Classic	"GPIB= <i>addr</i> " "GPIB"
Defaults	"GPIB 10"
Arguments	<i>addr</i> : The address of the GPIB488 interface (1 to 31)
Remarks	The GPIB address is changed following the reply of this command. Each device on a GPIB interface bus requires a unique address.
Example (enhanced)	Cmd sent: "GPIB 21" Query reply "21" (No reply if IEEE-488)
Example (enhanced)	Cmd sent: "GPIB? 21" Query reply "21"
Example (classic)	Sent: "GPIB=21" Reply: "21"
Errors	ERR# 6: The argument is not within given limits.
See Also:	3.2.22

HEAD	
Purpose	Read or set the fluid head settings.
Command Query	"HEAD <i>h,u,f</i> " "HEAD?"
Classic	"HEAD= <i>h,u,f</i> " "HEAD"
Defaults	"HEAD 0,cm,N2"
Arguments	<i>h</i> : The height of the test in relation to the PPC4. This is positive if the test is above the PPC4E, or negative if below the PPC4. This value can be between - 9999 and 9999. Setting this value to '0' disables the head correction. <i>u</i> : The height units. This must be "in" or "cm". <i>f</i> : The fluid type. This must be "N2", "Air", "He" or "User".
Remarks	The PPC4E can make a fluid head correction to allow it to display the pressure at the level of the device under test instead of at the level of the PPC4.
Example (enhanced)	Cmd sent: "HEAD 10,in,N2" Query reply: "10, in, N2"
Example (classic)	Sent: "HEAD=10,in,N2" Reply: "10, in, N2"
Errors	ERR# 6: The arguments are not within given limits.
See Also:	3.2.15

HS	
Purpose	Read or set the automated pressure control hold limit as a pressure value.
Command Query	"HS <i>hold</i> " "HS?"
Classic	"HS= <i>hold</i> " "HS"
Arguments	<i>Hold</i> : The hold limit in the current pressure unit of measure.
Remarks	The hold limit can be read and set as a pressure.
Example (enhanced)	Cmd sent: "HS .1" Query reply: "0.1 kPa" (No reply if IEEE-488)
Example (enhanced)	Cmd sent: "HS? .1" Query reply: "0.1 kPa"
Example (classic)	Sent: "HS=0.1" Reply: "0.1 kPa"
Errors	ERR# 6 The ' <i>hold</i> ' argument was invalid.
See Also	"HS%" 3.2.2 , 3.2.12

HS%	
Purpose	Read or set the automated pressure control hold limit for as a percent of range span.
Command Query	"HS% <i>hold</i> " "HS%?"
Classic	"HS%= <i>hold</i> " "HS%"
Arguments	<i>hold</i> : The hold limit in % span of the active range.
Remarks	The hold limit can be read and set as a pressure or as a percent of the span.
Example (enhanced)	Cmd sent: "HS .01" Query reply: "0.0100 %" (No reply if IEEE-488)
Example (enhanced)	Cmd sent: "HS? .01" Query reply: "0.0100 %"
Example (classic)	Sent: "HS=.01" Reply: "0.0100 %"
Errors	ERR# 6 The ' <i>hold</i> ' argument was invalid.
See Also	"HS" 3.2.2 , 3.2.12

ID	
Purpose	Read or set the user defined instrument identification label.
Command	"ID string"
Query	"ID"
Classic	"ID=string" "ID"
Arguments	String: An alphanumeric string up to 12 characters long.
Remarks	The user defined ID label can be used to allow the user to "tag" the PPC4E with a unique identifier. This ID is stored in non-volatile memory and cannot be erased by a power failure, system fault or reset
Example (enhanced)	Cmd sent: "ID PPCK #A01" Query reply: "PPCK #A01" (No reply if IEEE-488)
Example (enhanced)	Cmd sent: "ID PPCK? #A01" Query reply: "PPCK #A01"
Example (classic)	Sent: "ID=PPCK #A01" Reply: "PPCK #A01"
Errors	ERR# 6 The 'string' argument was longer than 12 char.
See Also	3.2.25.1

IF	
Purpose	Increase the pressure quickly (fast).
Command	"IF n"
Classic	"IF=n"
Arguments	n: '0' Closes the fast up valve. '1' Opens the fast up valve.
Remarks	Opening the fast up valve causes the pressure to increase quickly. Care must be used, as the pressure will not stop increasing until the valve is closed, or the upper limit is exceeded.
Example (enhanced)	Cmd sent: "IF 1" Reply: "1" (no reply if IEEE-488)
Example (enhanced)	Cmd sent: "IF? 1" Reply: "1"
Example (classic)	Sent: "IF=1" Reply: "IF=1"
Errors	ERR# 6: The n argument is a '0' or a '1'.
See Also	"DF", "IS", "DS", "IP", "DP", Figure 17

IP	
Purpose	Increase the pressure a given amount using the slow speed.
Command	"IP n"
Classic	"IP=n"
Arguments	n: The increase in pressure desired (current pressure units). This can be from 0 to 2 % FS of the active range.
Remarks	The slow speed will be used for a calculated amount of time (up to 5 seconds) to create the desired change. The PPC4E will not attempt to control the pressure to a target, so the change in pressure will be approximate. This is the equivalent of using  .
Example (enhanced)	Cmd sent: "IP 2" Reply: "2.000 kPa" (no reply if IEEE-488)
Example (enhanced)	Cmd sent: "IP? 2" Reply: "2.000 kPa"
Example (classic)	Sent: "IP=2" Reply: "2.000 kPa"
Errors	ERR# 6: The n argument is not within given limits.
See Also	"DP", "IF", "DF", "IS", "DS" 3.2.1

IS	
Purpose	Increase the pressure slowly.
Command	"IS <i>n</i> "
Classic	"IS= <i>n</i> "
Arguments	<i>n</i> : '0' Closes the slow up valve. '1' Opens the slow up valve.
Remarks	Opening the slow up valve causes the pressure to increase slowly. Care must be used, as the pressure will not stop increasing until the valve is closed, or the upper limit is exceeded.
Example (enhanced)	Cmd sent: "IS 1" Reply: "1" (no reply if IEEE-488)
Example (enhanced)	Cmd sent: "IS? 1" Reply: "1"
Example (classic)	Sent: "IS=1" Reply: "IS=1"
Errors	ERR# 6: The <i>n</i> argument is a '0' or a '1'.
See Also	"DS", "IF", "DF", "IP", "DP" Figure 17

L2 / L3	
Purpose	Read or set the type of program command format to use (classic or enhanced).
Command	"L2" enables "classic" mode "L3" enables "enhanced" mode
Defaults	"L2" (Classic mode)
Remarks	The user can select the type of remote command format using these simplified commands. There is no query format. This command is a replacement for the "MSGFMT" command.
Example (enhanced)	Cmd sent: "L3" Query reply: "L3" (No reply if IEEE-488)
Example (classic)	Sent: "L2" Reply: "L2"
See Also	"MSGFMT" 5.3

LL(=)	
Purpose	Read or set the lower pressure limit for the active range and measurement mode (negative gauge measurement mode only).
Command	"LL <i>n</i> "
Classic	"LL= <i>n</i> "
Arguments	<i>n</i> : The lower pressure limit for the current pressure range in the current unit of measure. Value is always a negative value of gauge pressure.
Remarks	Negative gauge mode in PPC4E has a lower limit. New automated pressure control targets can not be less than this value. If the pressure exceeds the lower limit, the pressure display flashes, and pressure control is aborted. Manual decreases in pressure are not allowed as long as the pressure is below the lower limit. Increases in pressure are allowed. This feature should always be used to prevent accidental over (under) pressure of a device under test.
Example (enhanced)	Cmd sent: "LL -4" Reply: "-4 kPa g" (no reply if IEEE-488)
Example (enhanced)	Cmd sent: "LL? -4" Reply: "-4 kPa g"
Example (classic)	Sent: "LL=-4" Reply: "-4 kPa g"
Errors	ERR# 6: The <i>n</i> argument is invalid. ERR# 23 The mode must be negative gauge to specify a lower limit.
See Also	"UL" 3.2.20

LOCAL	
Purpose	Returns control to the PPC4E front panel.
Command	"LOCAL"
Classic	"LOCAL"
Remark	The REMOTE program message can lock the front panel out completely. The user can return to local operation by sending the LOCAL program message, sending the IEEE-488 'GTL' command (if in enhanced format), or by cycling PPC4E power.
Example (enhanced)	Cmd sent: "LOCAL" Reply: "LOCAL" (no reply if IEEE-488)
Example (enhanced)	Cmd sent: "LOCAL?" Reply: "LOCAL"
Example (classic)	Sent: "LOCAL" Reply: "LOCAL"
See Also	"REMOTE"
MEM	
Purpose	Read the status from the power-up memory test.
Query	"MEM?"
Classic	"MEM"
Remarks	The PPC4E system memory stores the user settings (units, resolution, generation settings) and retains them when the unit is OFF. On power-up, this memory is checked. If this memory is corrupted, all user settings are reset to default, and the MEM status will be set to reflect this.
Example (enhanced)	Query sent: "MEM?" Reply: "0" PPC4E data corrupted and was set to factory defaults. "1" The memory was found to be OK on power-up.
Example (classic)	Sent: "MEM" Reply: "MEM=0" PPC4E data corrupted and was set to factory defaults. "MEM=1" The memory was found to be OK on power-up.
See Also	3.2.25.5
MODE	
Purpose	Read or set the automated pressure control mode.
Command	"MODE <i>n</i> "
Query	"MODE?"
Classic	"MODE= <i>n</i> " "MODE"
Arguments	<i>n</i> : '0' for static pressure control. '1' for dynamic pressure control.
Remarks	The method which the PPC4E controls pressure is selected with the "MODE" program message. When the control mode is set, control parameters go to default parameters for that range. The control mode setting is range dependent.
Example (enhanced)	Cmd sent: "MODE 1" Query reply: "1" (No reply if IEEE-488)
Example (enhanced)	Cmd sent: "MODE? 1" Query reply: "1"
Example (classic)	Sent: "MODE=1" Reply: "MODE=1"
Errors	ERR# 6 The argument is invalid.
See Also	"HS", "SS" 3.2.12, 3.2.2

MMODE	
Purpose	Read or change the active measurement mode.
Command	"MMODE= <i>mode</i> "
Query	"MMODE"
Classic	"MMODE= <i>mode</i> " "MMODE "
Arguments	<p><i>Mode:</i></p> <ul style="list-style-type: none"> "A" Absolute mode "G" Gauge mode "N" Negative gauge mode <p style="text-align: center;">Note</p> <p style="text-align: center;">Measured pressure values are returned with "g" to identify measurement mode for both gauge and negative gauge measurement modes.</p>
Remarks	The active RPT or an AutoRange range should be selected before setting measurement mode since measurement mode is range specific. The measurement mode can also be set using the "UNIT" command but the "UNIT" command does not distinguish between gauge and negative gauge while the "MMODE" does.
Example (enhanced)	Cmd sent: "MMODE A" Query reply: "A" (No reply if IEEE-488)
Example (enhanced)	Cmd sent: "MMODE? A" Query reply: "A"
Example (enhanced)	Cmd sent: "MMODE=G" Query reply: "G"
Errors	<p>ERR# 6: Invalid argument text.</p> <p>ERR# 7: Abs mode only with altitude units or gauge mode only with gauge RPT. Absolute or negative gauge mode not available with gauge RPT or absolute RPT with an absolute and negative gauge OFF calibration. The current range cannot support gauge mode.</p> <p>ERR# 20:</p> <p>ERR# 53: Not available.</p>
See Also	"UNIT" 3.2.10

MSGFMT	
Purpose	Read or set the type of program command format to use (enhanced or classic).
Command	"MSGFMT <i>n</i> "
Query	"MSGFMT?"
Classic	"MSGFMT= <i>n</i> " "MSGFMT"
Arguments	<p><i>n:</i></p> <ul style="list-style-type: none"> '1' to use the enhanced command format. '0' to use the classic command format.
Defaults	"MSGFMT 0"
Remarks	<p>The user can select the type of remote command format to use. This format must agree with the format sent to the PPC4.</p> <p>The enhanced query form of this command ("MSGFMT? <i>n</i>") should always be used to set the desired format, as it will be accepted regardless of the current format (classic or enhanced).</p>
Example (enhanced)	Cmd sent: "MSGFMT 1" Query reply: "1" (No reply if IEEE-488)
Example (enhanced)	Cmd sent: "MSGFMT? 1" Query reply: "1"
Example (classic)	Sent: "MSGFMT=1" Reply: "MSGFMT=1"
Errors	ERR# 6: Missing or improper program message argument(s).
See Also	5.3

NVENT	
Purpose	Read or set the status of TEST (-) (negative) vent valve (Gxxx or BGxxx RPT only)
Command	"NVENT <i>n</i> "
Query	"NVENT?"
Classic	"NVENT= <i>n</i> " "NVENT"
Default	"NVENT AUTO"
Arguments	<i>n</i> : '0' to close the low vent valve. '1' to open the low vent valve. 'AUTO' for the PPC4E to automatically open and close the low vent valve.
Remarks	PPC4E 15K and PPC4EX 100k have a valve that is used to vent the TEST (-) port. This valve is normally controlled automatically depending on current PPC4E operation but it can be commanded to open or close using the "NVENT" command. The PPC4E may not immediately open the negative vent valve when commanded to do so, as it checks to make sure that such an action will not cause harm to the low pressure RPT. The reply includes two fields. The first indicates the low vent status. The second indicates whether the low vent function is AUTO or MANUAL
Example (enhanced)	Cmd sent: "NVENT 0" Query reply: "0, MANUAL"
Example (enhanced)	Cmd sent: "NVENT? AUTO" Query reply: "1, AUTO"
Example (classic)	Sent: "NVENT=1" Query reply: "0, MANUAL"
See Also	"VENT" 3.2.25.6

PASSTHRU	
Purpose	To allow the host PC to communicate with a device connected to the PPC4E COM2 port.
Command	"PASSTHRU <i>n</i> "
Query	"PASSTHRU?"
Classic	"PASSTHRU= <i>n</i> " "PASSTHRU"
Arguments	<i>n</i> : The string to send out of the COM2 port. It must be less than 40 characters long.
Remarks	The COM2 port can be used to communicate to another RS232 device (such as another PPC4). This allows the user to use one COM port or IEEE-488 port on the host computer to communicate with the PPC4E and another device. The Command format specifies and sends the argument. A carriage return and a line feed (<CR><LF>) are added to the string that is sent. The Query format is used to check the PPC4E COM2 receive buffer to see if a message has been received on COM2 from the device. The message received by the COM2 port must be terminated with a carriage return or a carriage return and a line feed. Only one message is retained by the COM2 port. The label "COM2:" precedes the message text. If the COM2 receive buffer is empty, then the reply is just be 'COM2:'
Example (enhanced)	Cmd sent: "PASSTHRU VER" Query reply: "COM2:FLUKE PPC4E VER1.01a" Query reply: "COM2:" (If the COM2 buffer is empty)
Example (classic)	Sent: "PASSTHRU=VER" Reply: "COM2:FLUKE PPC4E VER1.01a" Reply: "COM2:" (If the COM2 buffer is empty)
See Also	"#", "COM2" 5.2.1.1, 5.2.1.2

PCAL:IH and PCAL:IL	
Purpose	Read or set the RPT or utility sensor calibration information for the "IH" (internal high) and "IL" (internal low) RPTs. "IH" is equivalent to "IuH".
Command	"PCAL:IH <i>adder, mult, CalDate, (GaOnly)</i> "
Query	"PCAL:IL <i>adder, mult, CalDate, (GaOnly)</i> " "PCAL:IH?" "PCAL:IL?"
Classic	"PCAL:IH = <i>adder, mult, CalDate, (GaOnly)</i> " "PCAL:IL = <i>adder, mult, CalDate, (GaOnly)</i> " "PCAL:IH" "PCAL:IL"
Defaults	"PCAL:IH = 0.0, 1.0, 19800101, 0" "PCAL:IL = 0.0, 1.0, 19800101, 0"
Arguments	<i>Adder:</i> The RPT calibration adder (PA). In Pascal. <i>Mult:</i> The RPT calibration multiplier (PM) from 0.1 to 100. <i>CalDate:</i> The date of the calibration in the format "YYYYMMDD" by default. The format "YYMMDD" is also be accepted, and the replied format is in the previously entered format. <i>GaOnly</i> Optional "Gauge only" flag. Indicates that the an Axxx RPT is set to operate in gauge measurement mode only. This field does not apply and is ignored for BGxxx RPTs. '0' Absolute, negative gauge and gauge modes are available. '1' Gauge mode only.
Remarks	The user defined pressure calibration information for the specified RPT (IH or IL pressure) can be accessed with this program message. Using this program message overwrites the current calibration coefficients, so caution must be used. If the "GaMode" flag is set and the RPT is an Axxx RPT, then the RPT will only be allowed to operate in gauge mode. Changes made using this program message take effect immediately.
Example (enhanced)	Cmd sent: "PCAL:LO 2.1, 1.000021, 20011201, 0" Query reply: " 2.10 Pa, 1.000021, 20011201, 0" (No reply if IEEE-488)
Example (enhanced)	Cmd sent: "PCAL:LO? 2.1, 1.000021, 20011201, 0" Query reply: " 2.10 Pa, 1.000021, 20011201, 0"
Example (classic)	Sent: "PCAL:LO=2.1, 1.000021, 20011201, 1" Reply: " 2.10 Pa, 1.000021, 20011201, 1"
Errors	ERR# 6: One of the arguments is out of range.
See Also	6.2

PR	
Purpose	Read the next available pressure.
Query	"PR?"
Classic	"PR"
Remarks	The next available pressure value for the active RPT or utility sensor is read in the current pressure units. The data returned also contains <i>Ready/Not Ready</i> information, and the pressure unit of measure and measurement mode. The reply field is always 20 characters long. The first 3 characters of the reply are reserved for the ready status (R or NR). The ready status is described in the "SR" program message. The pressure value and pressure unit of measure are right justified in this field. After receiving this program message, the PPC4E replies back with the data after a new pressure measurement cycle is complete. This can take up to 1.5 seconds.
Example (enhanced)	Query sent: "PR?" Query reply: "R 1936.72 kPaa"
Example (classic)	Query sent: "PR" Reply: "R 1936.72 kPaa"
See Also	"PRR", "QPRR", "SR" 3.2.3

PRR	
Purpose	Read the next available pressure, rate, on-board barometer reading, control status, and the QRPT uncertainty.
Query	"PRR?"
Classic	"PRR"
Remarks	<p>The next available <i>Ready</i> condition, RPT or utility sensor pressure, rate of pressure change, barometric pressure, generation status and RPT uncertainty is replied in the current pressure unit of measure. Each data field is separated by a comma, and is returned in the following order up to 1.2 seconds after the command is received:</p> <p style="padding-left: 40px;">ready, pressure UNITS, rate UNITS/s, atm UNITS, status, uncert UNITS</p> <p>Here are the field descriptions:</p> <p>ready: 'R' if the current pressure <i>Ready</i> criteria has been met, 'NR' if the criteria has not been met (see the "SR" program message).</p> <p>pressure: The measured pressure for the active RPT or utility sensor in the current pressure unit. This is followed by the current pressure unit.</p> <p>rate: The measured rate of pressure change for the active RPT or utility sensor in the current pressure unit per second. This is followed by the current pressure unit of measure.</p> <p>atm: The pressure measured by the PPC4E on-board barometer in the current pressure unit (and always absolute). This is followed by the current pressure unit. Not all PPC4s are equipped with an on-board barometer. This field is "NONE" if the PPC4E is not equipped with an on-board barometer.</p> <p>status: Generation status. Similar to the reply of the STAT command. Can be a sum of the following states::</p> <ul style="list-style-type: none"> 0 The system is not generating or holding a pressure or vented. 1 A new generation is preparing to start. 2 Quick ramping to the target. 4 Quick pulsing to the target. 8 Slow ramping to the target. 16 Slow pulsing to the target. 32 Reached the target, will re-adjust as needed to stay ready. 64 Quick ramping to a vent condition. 128 Executing a purge operation. 256 Quickly decreasing the pressure to reach a hard vacuum. 512 System is vented 1024 A new target has been requested but generation has not started. 2048 PWM low pressure control 4096 Dynamic pulsing is being used to control a pressure. 8291 Static pulsing is being used to control a pressure. 16394 Low pressure pulsed control is active. 32768 Very low pressure pulsed control is active. 65536 Determining external volume <p>uncert: The uncertainty is calculated as the measured uncertainty or the delivered uncertainty, depending on the current setting as determined by the DISPUNC command. Always returned as '0' for utility sensors.</p>
Example (enhanced)	<p>Query sent: "PRR?"</p> <p>Query reply: "R,2306.265 kPaa,0.011 kPa/s,97.000 kPaa, 0, 0.0034 kPa" "R,2306.265 kPaa,0.011 kPa/s, NONE, 0, 0.0034 kPa " (no barometer)</p>
Example (classic)	<p>Query sent: "PRR"</p> <p>Reply: "R,2306.265 kPaa,0.011 kPa/s,97.000 kPaa, 0, 0.0034 kPa"</p>
See Also	"PR", "QPRR", "SR", "DISPUNC" 3.2.2, 3.2.25.3, 3.2.27

PS	
Purpose	Set a new target pressure and start a new pressure generation cycle. Allows the test volume to be specified which causes the pressure generation cycle to be executed omitting the automated control configuration routine.
Command	"PS <i>n</i> (<i>,v</i>)"
Classic	"PS= <i>n</i> (<i>,v</i>)"
Arguments	<i>n</i> : The target pressure in the current pressure units. <i>v</i> : The volume of the system connected to the PPC4E TEST(+) port in cm ³ (cc). This argument is optional and should be used only to reduce pressure setting time in know volumes.
Remarks	The PPC4E sets the specified target pressure using the current control settings and mode. Control continues until a new target pressure is set, the PPC4E goes into LOCAL mode, or an "ABORT" program message is executed. If the given target is '0' and the pressure units are gauge, the PPC4E vents. The "PR?", "PRR?", "STAT?", or "SR?" program message queries can be used to monitor the progress of the pressure setting routine. If the optional " <i>v</i> " argument is used, the PPC4E does not perform its test volume determination routine at the beginning of the pressure setting procedure, but instead uses the volume specified for the pressure generation. This can reduce pressure set times when operating into a consistent volume since the configuration routine takes 5 to 6 seconds to execute. The " <i>v</i> " argument should only be used in automated conditions, where the test volume is constant and the configuration does not change. This argument is only an approximation value, and it may be adjusted empirically for correct operation. A higher " <i>v</i> " setting speeds up the generation with a higher risk of significant control overshoot. A lower " <i>v</i> " setting slows down the generation and reduces overshoot. Note: When using a BG15K or G15K low gauge pressure RPT with a DVU, the volume size specified should NOT include the DVU volume.
Example (enhanced)	Cmd sent: "PS 1000" Reply: "1000.000 kPa a " (no reply if IEEE-488)
Example (enhanced)	Cmd sent: "PS? 1000" Reply: "1000.000 kPa a "
Example (classic)	Sent: "PS=1000, 75" (includes test volume definition) Reply: "1000.000 kPa a "
Errors	ERR# 6 The target pressure is out of range.
See Also	"PR", "PRR", "STAT", "SR", "QPRR" 3.2.2, 3.2.11

PSF	
Purpose	Set a new target pressure, using only the fast control valve(s) and aborting pressure control once the pressure target is reached..
Command	"PSF <i>n</i> "
Classic	"PSF= <i>n</i> "
Arguments	<i>N</i> : The target pressure in the current pressure unit of measure.
Remarks	The PPC4E sets the given target pressure using just the fast speed, and stops controlling when the pressure has reached or passed the given target. The system does not attempt to maintain the target pressure. The "PR?", "PRR?", "STAT?", or "SR?" program message queries can be used to monitor the progress of the generation.
Example (enhanced)	Cmd sent: "PSF 1000" Reply: "1000.000 kPa a (no reply if IEEE-488)
Example (classic)	Sent: "PSF=1000" Reply: "1000.000 kPa a "
Errors	ERR# 6 The target pressure is out of range.
See Also	"PR", "PRR", "STAT", "SR", "PSS", "PS" Figure 17

PSS	
Purpose	Set a new target pressure using only the slow control valve(s) and aborting pressure control once the target is reached.
Command	"PSS <i>n</i> "
Classic	"PSS= <i>n</i> "
Arguments	<i>N</i> : The target pressure in the current pressure units.
Remarks	The PPC4E sets the given target pressure using just the slow speed, and stops controlling when the pressure has reached or passed the given target. The system does not attempt to maintain the target pressure. The "PR?", "PRR?", "STAT?", or "SR?" program message can be used to monitor the progress of the generation.
Example (enhanced)	Cmd sent: "PSS 1000" Reply: "1000.000 kPaa" (no reply if IEEE-488)
Example (enhanced)	Cmd sent: "PSS? 1000" Reply: "1000.000 kPaa"
Example (classic)	Sent: "PSS=1000" Reply: "1000.000 kPaa"
Errors	ERR# 6 The target pressure is out of range.
See Also	"PR", "PRR", "STAT", "SR", "PSF", "PS" Figure 17

QPRR	
Purpose	Quickly read the last known pressure, rate, on-board barometer reading, control status and QRPT uncertainty.
Query	"QPRR?"
Classic	"QPRR"
Remarks	<p>The last known <i>Ready</i> condition, RPT or utility sensor pressure, rate of pressure change, barometric pressure, generation status and RPT uncertainty is replied in the current pressure unit of measure. Each data field is separated by a comma, and is returned in the following order:</p> <p style="padding-left: 40px;">ready, pressure UNITS, rate UNITS/s, atm UNITS, status, uncert UNITS</p> <p>Here are the field descriptions:</p> <p>ready: 'R' if the current pressure <i>Ready</i> criteria has been met, 'NR' if the criteria has not been met (see the "SR" program message).</p> <p>pressure: The measured pressure for the active RPT or utility sensor in the current pressure unit. This is followed by the current pressure unit.</p> <p>rate: The measured rate of pressure change for the active RPT or utility sensor in the current pressure unit per second. This is followed by the current pressure unit of measure.</p> <p>atm: The pressure measured by the PPC4E on-board barometer in the current pressure unit (and always absolute). This is followed by the current pressure unit. Not all PPC4s are equipped with an on-board barometer.</p> <p>status: This field is "NONE" if the PPC4E is not equipped with an on-board barometer. Generation status. Similar to the reply of the STAT command. Can be a sum of the following states:</p> <ul style="list-style-type: none"> 0 The system is not generating or holding a pressure or vented. 1 A new generation is preparing to start. 2 Quick ramping to the target. 4 Quick pulsing to the target. 8 Slow ramping to the target. 16 Slow pulsing to the target. 32 Reached the target, will re-adjust as needed to stay ready. 64 Quick ramping to a vent condition. 128 Executing a purge operation. 256 Quickly decreasing the pressure to reach a hard vacuum. 512 System is vented 1024 A new target has been requested but generation has not started. 2048 PWM low pressure control 4096 Dynamic pulsing is being used to control a pressure. 8291 Static pulsing is being used to control a pressure. 16394 Low pressure pulsed control is active. 32768 Very low pressure pulsed control is active. 65536 Determining external volume <p>uncert: The uncertainty is calculated as the measured uncertainty or the delivered uncertainty, depending on the current setting as determined by the DISPUNC command. Always returned as '0' for utility sensors.</p>
Example (enhanced)	<p>Query sent: "QPRR?"</p> <p>Query reply: "R,2306.265 kPaa,0.011 kPa/s,97.000 kPaa, 0, 0.0034 kPa" "R,2306.265 kPaa,0.011 kPa/s, NONE, 0, 0.0034 kPa" (no barometer)</p>
Example (classic)	<p>Query sent: "QPRR"</p> <p>Reply: "R,2306.265 kPaa,0.011 kPa/s,97.000 kPaa, 0, 0.0034 kPa"</p>
See Also	"PR", "PRR", "SR", "DISPUNC" 3.2.2, 3.2.25.3, 3.2.27

RANGE (PPC4E version)	
Purpose	Change the active range to one of the available default RPT ranges. Read the active range full scale, pressure unit and measurement mode.
Command Query	"RANGE <i>Rng</i> " "RANGE?"
Classic	"RANGE= <i>Rng</i> " "RANGE "
Default	"RANGE IH" <i>Rng</i> : "IH" for the internal, hi RPT or utility sensor "IL" for the internal lo RPT
Remarks	The active RPT must be selected before making changes to settings that are dependent on the range. The system MUST BE VENTED to change active RPTs. RPTs selected with this command are used with their full default pressure range. The reply indicates the active range in psi if the PPC4E is a "US" version or in kPa if the PPC4E is an "SI" version. Used as a simple query, the active range is returned, which can be an AutoRanged range or a default range (see "ARANGE" cmd).
Example (enhanced)	Cmd sent: "RANGE IL" (select Lo RPT in it's full default range) Query reply: "50 psia" (no response in IEEE-488)
Example (classic)	Sent: "RANGE=IH" (select Hi RPT in it's full default range) Reply: "1000 psia"
Example (classic)	Sent: "RANGE" (request current range) Reply: "220 psia"
Errors	ERR# 6: Invalid <i>Rng</i> argument. ERR# 22: System must be vented for the requested operation. ERR# 38: The selected RPT is not available.
See Also	"ARANGE", "RPT" 3.2.6, 3.2.8, Error! Reference source not found.

RATE	
Purpose	Read the next available pressure rate of change.
Query	"RATE?"
Classic	"RATE"
Remarks	The next available pressure rate of change in the current pressure unit per second is returned. After receiving this program message, the PPC4E replies back with the data once a new pressure measurement cycle is complete. This can take up to 1.5 seconds.
Example (enhanced)	Query sent: "RATE?" Query reply: "0.01 kPa/s"
Example (classic)	Sent: "RATE" Reply: "0.01 kPa/s"
See Also	"PRR", "QPRR"

READYCK	
Purpose	Read or set the <i>Ready</i> check flag.
Command	"READYCK 1"
Query	"READYCK?"
Classic	"READYCK=1" "READYCK"
Remarks	The internal ready check flag is cleared whenever the PPC4E reaches a <i>Not Ready</i> (NR) condition. The "READYCK" query returns the status of the flag. The flag is set by sending the "READYCK 1" program message while the PPC4E is in a <i>Ready</i> condition. The "READYCK" program message query can then be used at a later time to determine whether a <i>Not Ready</i> condition has occurred since the ready check flag was set.
Example (enhanced)	Cmd sent: "READYCK 1" Query reply: "1" (no reply if IEEE-488)
Example (enhanced)	Cmd sent: "READYCK?" Query reply: "1"
Example (enhanced)	Cmd sent: "READYCK?" Query reply: "1" (if PPC4E condition has stayed <i>Ready</i>) "0" (if PPC4E condition has NOT stayed <i>Ready</i>)
Example (classic)	Sent: "READYCK=1" Query reply: "READYCK=1"
Example (classic)	Sent: "READYCK" Query reply: "READYCK=1" (if PPC4E condition has stayed <i>Ready</i>) "READYCK=0" (if PPC4E condition has NOT stayed <i>Ready</i>)
Errors	ERR# 6: Argument is not a '0' or a '1'.
See Also	"SR" 3.2.3

REMOTE	
Purpose	Lock out the front panel keypads during remote operation.
Command	"REMOTE"
Classic	"REMOTE"
Remarks	The PPC4E goes into remote mode whenever communications take place. The user can return to local operation by pressing Esc . The REMOTE program message locks out the front panel completely. The only way to unlock the front panel after the "REMOTE" command is using the "LOCAL" program message, the IEEE-488 "GTL" command, or by cycling the PPC4E power.
Example (enhanced)	Cmd sent: "REMOTE" Reply: "REMOTE" (no reply if IEEE-488)
Example (enhanced)	Cmd sent: "REMOTE?" Reply: "REMOTE"
Example (classic)	Sent: "REMOTE" Reply: "REMOTE"
See Also	"LOCAL"

RES	
Purpose	To read or set the pressure display resolution for the active range.
Command	"RES <i>n</i> "
Query	"RES"
Classic	"RES= <i>n</i> " "RES"
Default	"RES 0.001"
Arguments	<i>n</i> : The pressure display resolution in % span of the current RPT range (0.0001 to 1 % FS).
Remarks	The pressure display resolution is defined as % span of the active range. The setting is separate for each range, and changes as the range is changed.
Example (enhanced)	Cmd sent: "RES .01" Query reply: "0.01" (No reply if IEEE-488)
Example (enhanced)	Cmd sent: "RES? .01" Query reply: "0.01"
Example (classic)	Sent: "RES=.01" Reply: "0.01"
Errors	ERR# 6 The argument is invalid.
See Also	3.2.18

RESET	
Purpose	Reset the user's settings to factory defaults.
Command	"RESET"
Classic	"RESET"
Remarks	The PPC4E has user settings (units, resolution, control modes, etc.) that can be reset to factory defaults. System calibration coefficients and communications settings are not affected. The remote "RESET" program message corresponds to the front panel "Reset Settings." The reset cycle takes up to 5 seconds to complete and involves a power cycle of the PPC4. Remote communications should not take place during this period.
Example (enhanced)	Cmd sent: "RESET" Reply: "RESET" (no reply if IEEE-488)
Example (enhanced)	Cmd sent: "RESET?" Reply: "RESET"
Example (classic)	Sent: "RESET" Reply: "RESET"
See Also	3.2.23.1

RETURN	
Purpose	Start a new pressure setting sequence equivalent to the "PS" command using the last target pressure.
Command	"RETURN"
Classic	"RETURN"
Remarks	The "RETURN" program message starts a new pressure setting sequence using the current settings and target pressure. Pressure control continues until a new target pressure is set, the PPC4E is put into LOCAL mode, or an "ABORT" program message is executed.
Example (enhanced)	Cmd sent: "RETURN" Reply: "1000.000 kPaa" (no reply if IEEE-488)
Example (classic)	Sent: "RETURN" Reply: "1000.000 kPaa"
Errors	ERR# 6 The current target pressure is invalid.
See Also	"PS", "TP" 3.2.11

RPTn	
Purpose	Read the available RPT data or initiate the RPT search and initialize process.
Command Query	"RPT" "RPTn"
Classic	"RPT" "RPTn"
Default	"RPT"
Prefix (optional)	<i>n</i> Specify the position locator of the RPT about which to collect information: '1' The internal, Hi RPT '2' The internal, Lo, RPT
Remarks	This command allows query of the PPC4E RPTs. To query the unit for information about a particular RPT Using the postfix 'n.' The RPT data is returned in the following format: <i>RPTType, RPTLocator, Serial#, RngGa, RngAbs, RptMode</i> <i>RngLabe</i> : RPT type label. This label identifies the RPT type and range. This is the same label used on the PPC4E front panel screen. <i>RptLocator</i> : Text field identifying the RPT position in the PPC4E system. "IH" identifies this as an internal, Hi RPT "IL" identifies this as an internal, Lo RPT <i>Serial#</i> : The serial number of the PPC4E. <i>RngGa</i> : The RPT gauge mode range in the current pressure unit. <i>RngAbs</i> : The RPT absolute mode range in the current pressure unit. "NONE" appears in the field if the RPT is a BGxxx or Axxx with absolute and negative gauge modes OFF. <i>RptMode</i> : 'A' if RPT is Axxx and supports absolute, gauge and negative gauge measurement modes. 'G' if RPT is Axxx with absolute and negative gauge modes OFF and supports only gauge measurement mode. 'N' if RPT is BGxxx and supports gauge and negative gauge measurement modes.
Example (enhanced)	Cmd sent: "RPT2?" (Get information on internal, Lo RPT) Query reply: "A350K, IL, 82345, 35, 50,A"
Errors	ERR# 10: Invalid postfix.
See Also	"ARANGE" 3.2.5, Error! Reference source not found.

SCRSAV	
Purpose	Read or set the front panel display screen saver activation time & type.
Command Query	"SCRSAV <i>n,t</i> " "SCRSAV?"
Classic	"SCRSAV= <i>n, t</i> " "SCRSAV"
Arguments	<i>n</i> : The inactivity period. (minutes) after which screen saver activates. <i>t</i> : Optional screen saver type (GUI only): '0' Moving pressure screen saver '1' DHI screen saver
Default	"SCRSAV 10, 0"
Remarks	The PPC4E front panel will dim basic display or switch the GUI to a screen saver pattern after a period of keyboard and remote inactivity. Setting this value to '0' disables this feature.
Example (enhanced)	Cmd sent: "SCRSAV 30, 1" Query reply: "30, 1" (No reply if IEEE-488)
Example (enhanced)	Cmd sent: "SCRSAV? 30" Query reply: "30, 0"
Example (classic)	Sent: "SCRSAV=30, 0" Reply: "30, 0"
Errors	ERR# 6 The argument was invalid.
See Also	3.2.24.1

SN	
Purpose	To read the serial number of the PPC4.
Query	"SN?"
Classic	"SN"
Remarks	The PPC4E is serialized. The serial number can be read using this program message.
Example (enhanced)	Query sent: "SN?" Query reply: "321"
Example (classic)	Sent: "SN" Reply: "321"
See Also	3.2.25.1

SR	
Purpose	Read the next available <i>Ready/Not Ready</i> status.
Query	"SR?"
Classic	"SR"
Remarks	The current <i>Ready</i> status can be read using this program message. Possible replies: "NR" The pressure is Not Ready within the limits defined by the control mode and current control parameters. "R" The pressure meets the ready criteria. The status is replied when the next pressure measurement is finished. "OL" The pressure of one of the active RPTs has exceeded the user defined upper or lower limits. "OP" The pressure of one of the RPTs has exceeded the RPT's maximum limits. "ER" An internal device failure has occurred.
Example (enhanced)	Query sent: "SR?" Query reply: "NR"
Example (classic)	Sent: "SR" Reply: "NR"
See Also	"PR", "PRR", "HS", "SS", "UL", "LL" Commands 3.2.3, 3.2.20, 3.2.20.1

SS%	
Purpose	Read or set the current stability limit as a % of range.
Command	"SS% n"
Query	"SS%?"
Classic	"SS%=n" "SS%"
Arguments	n: The stability limit in %FS of the current active range.
Remarks	The stability limit can be read and set as a percent of the full scale range of the RPT range. If this program message is used to set the stability limit, the PPC4E will then use CUSTOM control settings.
Example (enhanced)	Cmd sent: "SS% .1" Query reply: "0.10 %" (No reply from IEEE-488)
Example (enhanced)	Cmd sent: "SS%? .1" Query reply: "0.10 %"
Example (classic)	Sent: "SS%=.1" Reply: "0.10 %"
Errors	ERR# 6 The argument was invalid.
See Also	"SS" 3.2.12

SS	
Purpose	Read or set the current pressure stability limit.
Command Query	"SS n" "SS?"
Classic	"SS=n" "SS"
Arguments	N: The stability limit in the current pressure unit of measure.
Remarks	The stability limit can be read and set as a pressure. The stability limit is used as the <i>Ready/Not Ready</i> criterion in static control mode and when PPC4E not controlling.
Example (enhanced)	Cmd sent: "SS .1" Query reply: "0.10 kPa/s" (No reply from IEEE-488)
Example (enhanced)	Cmd sent: "SS? .1" Query reply: "0.10 kPa/s"
Example (classic)	Sent: "SS=.1" Reply: "0.10 kPa/s"
Errors	ERR# 6 The argument was invalid.
See Also	"HS" 3.2.12

STAT	
Purpose	Read the pressure control status.
Query	"STAT?"
Classic	"STAT"
Remarks	<p>The pressure control cycle status can be checked using this program message. The reply is a numeric code which references a specific pressure control action: Multiple codes are returned by adding them together.</p> <ul style="list-style-type: none"> 0 The system is not generating or holding a pressure. 1 A new generation is preparing to start. 2 Quick ramping to the target. 4 Quick pulsing to the target. 8 Slow ramping to the target. 16 Slow pulsing to the target. 32 Reached the target, will re-adjust as needed to stay ready. 64 Quick ramping to a vent condition. 128 Executing a purge operation. 256 Quickly decreasing the pressure to reach a hard vacuum. 1024 A new target has been requested but generation has not started. 2048 PWM low pressure control 4096 Dynamic pulsing is being used to control a pressure. 8192 Static pulsing is being used to control a pressure. 16394 Low pressure pulsed control is active. 32768 Very low pressure pulsed control is active. 65536 Determining external volume
Example (enhanced)	Query sent: "STAT?" Query reply: "32"
Example (classic)	Sent: "STAT" Reply: "32"
See Also	"PS" 3.2.2, 3.2.11

TIME	
Purpose	Read or set the PPC4E internal clock.
Purpose	Read or set the PPC4E internal clock.
Command Query	"TIME hh:mm:ssXX" or "TIME hh:mm:ss "TIME?"
Classic	"TIME=hh:mm:ssXX" or "TIME=hh:mm:ss" "TIME"
Arguments (12 hour mode)	<i>hh:mm:</i> The time in a 12 hour format using a colon delimiter. <i>XX:</i> "am" or "pm"
Arguments (24 hour mode)	<i>hh:mm:</i> The time in a 24 hour format using a colon delimiter
Remarks	The PPC4E has an internal real time clock. It is used for date stamping calibrations and log data. The TIMEFMT command can be used to set the clock for 12hr or 24hr mode
Example (enhanced 12hr)	Cmd sent: "TIME 12:52PM" Query reply: "12:52pm" (No reply if IEEE-488)
Example (enhanced 12hr)	Cmd sent: "TIME? 12:52PM" Query reply: "12:52pm"
Example (classic 12hr)	Sent: "TIME=12:52PM" Reply: "12:52pm"
Example (classic 24hr)	Sent: "TIME=18:22" Reply: "18:22"
Errors	ERR# 7: Missing or improper program message argument(s).
See Also	"TIMEFMT", "DATE" 3.2.24.3

TIMEFMT	
Purpose	Read or set the clock time format.
Command Query	"TIMEFMT <i>n</i> " "TIMEFMT?"
Classic	"TIMEFMT= <i>n</i> " "TIMEFMT"
Arguments	<i>n:</i> '0' 12 hour format '1' 24 hour format
Default	"TIMEFMT 0"
Remarks	The real time clock can be set to report time in either a 12 hour or a 24 hour format.
Example (enhanced)	Cmd sent: "TIMEFMT 1" Query reply: "1" (No reply if IEEE-488)
Example (enhanced)	Cmd sent: "TIMEFMT? 1" Query reply: "1"
Example (classic)	Sent: "TIMEFMT=0" Reply: "TIMEFMT=0"
Errors	ERR# 6 The argument was invalid.
See Also	"TIME" 3.2.24.3

TP	
Purpose	To read the current target pressure.
Query	"TP?"
Classic	"TP"
Remarks	The current target pressure is replied in the current pressure unit of measure.
Example (enhanced)	Query sent: "TP?" Query reply: "1000.00 kPa a"
Example (classic)	Sent: "TP" Reply: "1000.00 kPa a"
See Also	"PS" 3.2.2

UCOEF	
Purpose	To convert 1 Pascal to the current pressure units.
Query	"UCOEF?"
Classic	"UCOEF"
Remarks	The PPC4E handles all pressure values internally in Pascal. The coefficient replied is equivalent of 1 Pa in the current pressure unit of measure. This program message allows the user to convert pressures
Example (enhanced)	Query sent: "UCOEF?" Query reply: "0.0010000000 kPa"
Example (classic)	Sent: "UCOEF" Reply: "0.0010000000 kPa"
See Also	3.2.9, 8.2.1

UDUn	
Purpose	Read or set the user defined pressure units.
Command	"UDUn label, ucoef"
Query	"UDUn?"
Classic	"UDUn=label, ucoef" "UDUn" <i>label:</i> User unit label (5 alphanumeric char maximum). It cannot be an already supported unit label. <i>ucoef:</i> "User unit conversion coefficient (units/Pa).
Arguments	<i>n:</i> The optional user defined unit to access (1 to 5). Assumes '1' if not given.
Default	"UDU USER,1.0"
Remarks	The user defined unit must be set up with this command prior to remote or local selection. There are 5 separate user definable units. The GUI supports all 5 user defined user units, while the basic version only has access to the first one ($n = 1$)
Example (enhanced)	Cmd Sent: "UDU MYUN, .001" Query reply: "MYUN, 0.001000" (No reply if IEEE-488)
Example (enhanced)	Cmd Sent: "UDU? MYUN, .001" Query reply: "MYUN, 0.001000"
Example (classic)	Sent: "UDU=MYUN, .001" Reply: "MYUN, 0.001000"
Example (classic)	Sent: "UDU2=UN2, .01" Reply: "UN2, 0.010000"
See Also	3.2.9

UL	
Purpose	Read or set an upper limit for the current range.
Command	"UL n"
Query	"UL?"
Classic	"UL=n" "UL"
Arguments	<i>n:</i> The upper limit pressure in the current pressure unit and measurement mode.
Remarks	The PPC4E has an upper limit for each range and for each measurement mode (gauge and absolute). New automated pressure control targets cannot be greater than this value. If the pressure does exceed the upper limit, the pressure display flashes, and pressure control stops. Manual increases in pressure are not allowed as long as the pressure is above the upper limit. Decreases in pressure are allowed. This feature should always be used to prevent accidental over pressure of a device under test.
Example (enhanced)	Cmd sent: "UL 1000" Query reply: "1000.00 kPaa" (No reply if IEEE-488)
Example (enhanced)	Cmd sent: "UL? 1000" Query reply: "1000.00 kPaa"
Example (classic)	Sent: "UL=1000" Reply: "1000.00 kPaa"
Errors	ERR# 6: The argument is out of range.
See Also	"LL" 3.2.20

UNIT	
Purpose	Read or set the pressure unit of measure unit and measurement mode.
Command	"UNIT <i>unit</i> (<i>, ref</i>)" "UNIT <i>unitg</i> (<i>, ref</i>)" "UNIT <i>unita</i> (<i>, ref</i>)"
Query	"UNIT?"
Classic	"UNIT= <i>unit</i> (<i>, ref</i>)" "UNIT= <i>unitg</i> (<i>, ref</i>)" "UNIT= <i>unita</i> (<i>, ref</i>)" "UNIT"
Arguments	<i>unit</i> : The text corresponding to the pressure unit of measure. <i>ref</i> : The optional unit reference temperature only if the unit is "InWa".
Remarks	<p>This program message determines what unit of measure and what measurement mode is used to display pressure values. Refer to Table 13 for a detailed list of the units available and their labels.</p> <p>The unit text must be followed by 'a' if absolute measurement mode is desired, or gauge mode is assumed. The unit text can optionally be followed by a 'g' to specify gauge measurement mode. There can be a space between the unit text and the 'a' or the 'g'.</p> <p>If a water column unit (inH2O, mH2O, mmH2O) is specified for the pressure unit of measure, an optional second argument "<i>ref</i>" can be set. The "<i>ref</i>" can be 4, 20, or 60 corresponding to InH2O at 4 °C, 20 °C or 60 °F. The reference temperature can also be added directly onto the end of the <i>Unit</i> argument or "@" plus the reference temperature if desired ("inH2O4", "inH2O@4", "inH2O20", "inH2O@20", "inH2O60", or "inH2O@60 corresponding to inH2O at 4 °C, 20 °C or 60 °F). If a temperature reference is not specified, when the unit is "InH2O" or "mmH2O", then the reference temperature is assumed to be 20 °C.</p> <p style="text-align: center;">Note</p> <p style="text-align: center;">The legacy units inWa, mWa and mmWa have been replaced by inH2O, mH2O and mmH2O in the PPC4E and in documentation. The unit command and others such as ARANGE continue to support the former "xxWA" units. The conversion factors are identical.</p> <p>The fifth character of the reply is always 'a' for absolute mode, or 'g' for gauge mode. White spaces proceed this character if needed. The temperature reference is added to the reply only if the unit is "InWa" or "mmWa".</p> <p>"MMODE" must be used to set the measurement mode to negative gauge. The "MODE" command can also be used to set the desired measurement mode only.</p>
Example (enhanced)	Cmd sent: "UNIT kPaa" Query reply: "kPaa" Sent: "UNIT InH2Og, 4" Query reply: "inH2Og, 4" Sent: "UNIT InH2Og60" Query reply: "inH2Og, 60" Sent: "UNIT InH2O@20" Query reply: "inH2Og, 20"
Example (classic)	Sent: "UNIT=kPaa" Reply: "kPaa" Sent: "UNIT=InH2Og, 4" Reply: "inH2Og, 4" Sent: "UNIT=InH2Og@20" Reply: "inH2Og, 20"
Errors	ERR# 7: The <i>unit</i> is invalid. ERR# 6: The <i>ref</i> is invalid. ERR# 20: Absolute measurement mode and altitude units are not allowed with a gauge RPT.
See Also	"MMODE", "MODE" 3.2.9, 3.2.10

VAC	
Purpose	Read or set the status of the PPC4E EXHAUST port vacuum or atmosphere monitoring system.
Command	"VAC <i>n</i> "
Query	"VAC?"
Classic	"VAC= <i>n</i> " "VAC"
Default	"VAC 0"
Arguments	<i>n</i> : '0' To disable auto mode and specify that the PPC4E EXHAUST port is open to atmosphere. '1' To disable auto mode and specify that the PPC4E EXHAUST port is connected to a vacuum source. NOTE: Use "AUTOVAC" to enable automated determination of EXHAUST port conditions.
Remarks	The PPC4E has an internal sensor that determines if the EXHAUST port is open to atmosphere or to vacuum. You can manually override it if desired. The query can also be used to see the sensor status (if auto is enabled). If the auto function is disabled, then the query returns the last VAC setting.
Example (enhanced)	Cmd sent: "VAC 1" Query reply: "1" (No reply if IEEE-488)
Example (enhanced)	Cmd sent: "VAC? 1" Query reply: "1"
Example (classic)	Sent: "VAC=1" Query reply: "VAC=1"
Errors	ERR# 6: The argument is not a '0' or a '1'.
See Also	"AUTOVAC" 3.2.25.2

VENT	
Purpose	Read, execute or abort a vent process.
Command	"VENT <i>n</i> "
Query	"VENT?"
Classic	"VENT= <i>n</i> " "VENT"
Arguments	<i>N</i> : '1' to start a vent process. '0' to abort a vent process and close the exhaust valve.
Remarks	The PPC4E vents by setting pressure close to atmospheric and then opening the vent valve. This program message query returns a '0' if the vent valve is closed, or a '1' if the vent valve is open. In gauge measurement modes, a "PS" command of zero is interpreted as a vent command.
Example (enhanced)	Cmd sent: "VENT 1" Query reply: "0" (if not finished venting) (No reply if IEEE-488) "1" (if vented) (No reply if IEEE-488)
Example (enhanced)	Cmd sent: "VENT? 1" Query reply: "0" (if not finished venting) "1" (if vented)
Example (classic)	Sent: "VENT=1" Reply: "VENT=0" (if not finished venting) "VENT=1" (if vented)
Errors	ERR# 6: The argument is not a '0' or a '1'.
See Also	"PS" 3.2.1, 3.2.13

VER	
Purpose	Identify the PPC4E, US or SI units, the RPT labels and the software version.
Query	"VER?"
Classic	"VER"
Remarks	The software version of the PPC4E can be read. This is useful for checking for the presence of the PPC4E and for reference purposes. It indicates the internal RPT(s) and software version.
Example (enhanced)	Query sent: "VER?" Query reply: "FLUKE, PPC4E us A200K/BG15K Ver 1.02 "
Example (classic)	Query sent: "VER" Query reply: "FLUKE, PPC4E us A14M Ver 1.02 "
See Also	None

ZOFFSETn	
Purpose	Read or set the pressure offset (P_{offset}) for the specified or active RPT (preferred method).
Command	"ZOFFSETn <i>GaOffset</i> , <i>AbsOffset</i> "
Query	"ZOFFSETn?"
Classic	"ZOFFSETn= <i>GaOffset</i> , <i>AbsOffset</i> " "ZOFFSETn"
Defaults	"ZOFFSETn = 0.0 Pa, 0.0 Pa" (Gauge RPT) "ZOFFSETn = 101325 Pa, 0.0 Pa" (Absolute RPT)
Optional Suffix	"n" The active RPT is assumed if no suffix is given. '1' Specify the Hi RPT. '2' Specify the Lo RPT
Arguments	<i>GaOffset</i> The RPT pressure offset ("Poffset") for Gauge measurement mode (Pa). <i>AbsOffset</i> : The RPT pressure offset for absolute measurement mode (Pa)
Remarks	The pressure offset (P_{offset}) for the specified internal RPT (IH or IL) or the active RPT can be accessed with this program message. There is a separate offset for gauge and absolute measurement modes, but not all modes apply in all cases. (Gauge RPTs do not support " <i>AbsOffset</i> "). ⚠ Caution <ul style="list-style-type: none"> • Using this program message overwrites the current offset. • Changes made using this program message take effect immediately. • Pressure offsets (P_{offset}) are determined automatically by the PPC4E when vented. Modifying values will affect calibration of the sensors and may cause out of tolerance measurements.
Example (enhanced)	Cmd sent: "ZOFFSET1 2.1, 0" Query reply: " 2.10 Pa, 0.00 Pa"
Example (classic)	Sent: "ZOFFSET=97293.1, 3.02" Reply: " 97293.10, 3.02"
Errors	ERR# 6: One of the arguments is out of range.
See Also	Error! Reference source not found.

5.5 Status Reporting System

The PPC4E status reporting system is used to track and report system status and errors. It follows the model of the IEEE Std 488.2 and works for the COM1 and the IEEE-488 port with slight differences. The PPC4E can be programmed to respond to various status conditions by asserting the SRQ of the IEEE-488 interface. The COM1 port cannot be supported in such a way, so polling must be used.

5.5.1 Error Queue

The PPC4E keeps track of remote errors by using an error queue. If an error occurs, it is pushed onto the Error Queue. If you are using the COM1 port, the error number is immediately replied in the form "ERR#nn where nn is the error code from 0 to 99. The "ERR?" (or "ERR") query can then be used to pull the error from the Error Queue in it's descriptive text format. If you are using the enhanced program message format, the Error Queue will accumulate errors until full unless they are pulled from the queue. If you are using the classic program format, the Error Queue is cleared every time a new program message is received.

5.5.2 Status Byte Register

The PPC4E contains an 8 bit Status Byte Register that reflects the general status of the PPC4.

Table 19. 8 Bit Status Byte Register

OPER (128)	RQS/MSS (64)	ESB (32)	MAV (16)	N/A (8)	ERROR (4)	N/A (2)	RSR (1)
----------------------	------------------------	--------------------	--------------------	-------------------	---------------------	-------------------	-------------------

This register is affected by the PPC4E reply output queue, the Error Queue, the Standard Event Status register and the *Ready Event* Status register.

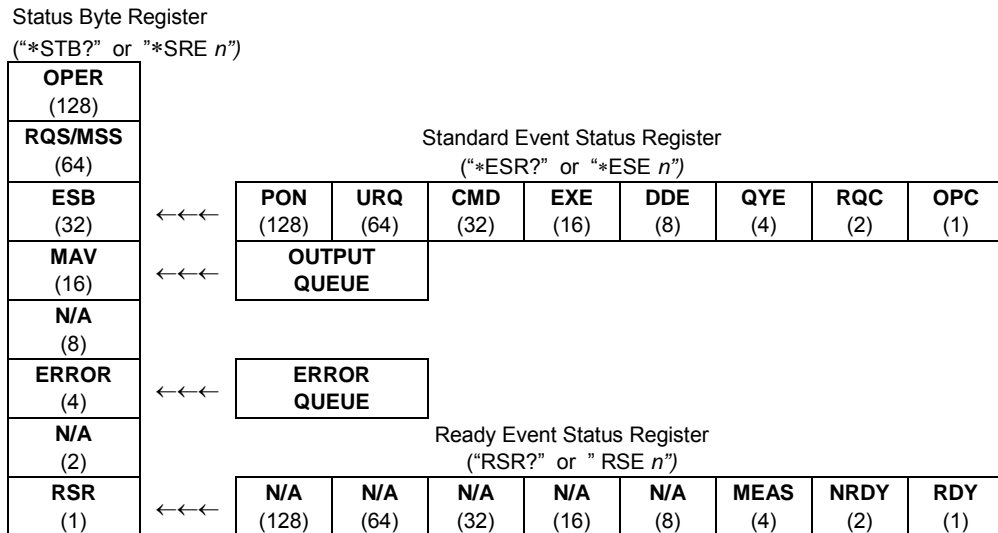

Figure 14. Status Register Schematic

The Status Byte Register can be read using the "***STB?**" query, or by performing a serial poll on the IEEE-488 bus. If you read this using a serial poll then Bit 6 is the RQS. If the "***STB?**" query is used, then bit 6 is the MSS bit. All of the other bits are common to both types of query.

Each of these status bits can cause a SRQ to occur. The Service Request Enable Register ("***SRE**" program message) determines which of these flags are able to assert the SRQ line. This enable register has a matching set of bits that each will enable the designated bit to cause a SRQ, except for the RQS/MSS bit(s) which cannot cause a SRQ. If you set this register to 20 (\$14 hex), an SRQ will occur if the MAV or the ERROR bit are set. The description of these bits are given as:

OPER	N/A Bit 7 (128)
RQS	Requested Service Bit 6 (64) Indicates that the SRQ line of the IEEE-488 interface has been asserted by the PPC4. This bit is cleared when a serial poll is performed on the PPC4E, and is a part of the Status Byte Register when read using a serial poll. This bit does not apply if the COM1 port is being used.
MSS	Master Summary Status Bit 6 (64) Indicates that an event or events occurred that caused the PPC4E to request service from the Host, much like the RQS bit. Unlike the RQS bit, it is READ ONLY and can be only cleared when the event(s) that caused the service request are cleared.
ESB	Event Summary Bit 5 (32) Indicates if an enabled bit in the Standard Event Status Register became set (see Section 4.5.3).
MAV	Message Available Bit 4 (16) Indicates that at least one reply message is waiting in the PPC4E IEEE-488 output queue.
ERROR	Error Queue Not Empty Bit 2 (4) Indicates that at least one command error message is waiting in the PPC4E IEEE-488 error message queue. Use the “ ERR? ” query to get this message.
RSR	Ready Summary Bit 0 (1) Indicates that an enabled bit in the Ready Status Register became set.

5.5.3 Standard Event Register

The PPC4E contains an 8 bit Standard event register that reflects specific PPC4E events. Enabled events in this register will set or clear the ESB bit of the Status Byte Register.

Table 20. 8 Bit Standard Event Register

PON	URQ	CMD	EXE	DDE	QYE	RQC	OPC
(128)	(64)	(32)	(16)	(8)	(4)	(2)	(1)

This register can be read using the “*ESR?” query, Each of these status bits can set the ESB bit of the Status Byte Register, causing a SRQ to occur IF the ESB bit is enabled to do so. The Standard Event Status Enable Register (“*ESE” program message) determines which of these flags are able to assert the ESB bit. The description of these bits are given as:

PON	Power On (Bit 7) Indicates that the PPC4E power has been cycled since the last time this bit was read or cleared.
URQ	User Request (Bit 6) Indicates that the PPC4E was set to local operation manually from the front panel by the user (pressing the [ESC] key).
CMD	Command Error (Bit 5) Indicates that a remote command error has occurred. A command error is typically a syntax error in the use of a correct program message.
EXE	Execution Error (Bit 4) Indicates if a remote program message cannot be processed due to device related condition.
DDE	Device Dependent Error (Bit 3) Indicates that an internal error has occurred in the PPC4E such as a transducer time-out.

- QYE** Query Error (Bit 2)
Indicates that an error has occurred in the protocol for program message communications. This is typically caused by a program message being sent to the PPC4E without reading a waiting reply.
- RQC** Request Control (Bit 1)
This bit is not supported as the PPC4E cannot become the active controller in charge.
- OPC** Operation Complete (Bit 0)
Indicates that the PPC4E has completed all requested functions.

5.5.4 Ready Status Register

The PPC4E contains an 8 bit Ready Status Register that reflects specific PPC4E measurement and generation ready events (see Section 3.2.3). Enabled events in this register will set or clear the RSB bit of the Status Byte Register.

Table 21. 8 Bit Ready Status Register

N/A (128)	N/A (64)	N/A (32)	N/A (16)	N/A (8)	MEAS (4)	NRDY (2)	RDY (1)
--------------	-------------	-------------	-------------	------------	-------------	-------------	------------

This register can be read using the “*RSR?” query, Each of these status bits can set the RSB bit of the Status Byte Register, causing a SRQ to occur IF the RSB bit is enabled to do so. The Standard Event Status Enable Register (“*RSE” program message) determines which of these flags are able to assert the RSB bit. The description of these bits are given as:

- MEAS** Measurement ready (Bit 2)
Indicates that the PPC4E has completed a RPT measurement.
- NRDY** Generation Not Ready (Bit 1)
Indicates that the PPC4E made a transition from *Ready* to *Not Ready* as defined by the control settings (see Section 3.2.2).
- RDY** Generation Ready (Bit 0)
Indicates that the PPC4E has reached a target pressure and is *Ready* as defined by the control settings (see Section 3.2.2).

5.6 IEEE STD. 488.2 Common and Status Program Messages

The PPC4E supports a set of commands that are common to all instruments conforming to IEEE Std. 488.2. These command make it easy to perform basic function for any device that supports these commands. These commands also cover the status reporting commands. See Section 4.5 for details on the status registers mentioned in these commands.

Table 22. Program Message List

*CLS	Clear all of the status & event structures.
*ESE	Read or set the Standard Event Status Enable Register.
*ESR	Read the Standard Event Status Register.
*IDN	Identify the PPC4E version, range, and serial number.
*OPC	Set the operation complete bit when all operations have completed.
*OPT	Read the list of installed PPC4E options.
*RST	Reset the PPC4E control settings to factory settings.
*TST	Read the power on self test status.
*SRE	Read or set the Service Request Enable Register.
*STB	Read the Status Byte Register.
*RSE	Read or set the Ready Status Enable Register.
*RSR	Read the Ready Status Register.

5.6.1 Program Message Descriptions

*CLS	
Purpose	Clear all of the status & event structures.
Command	"*CLS"
Remarks	This program message clears the following events and status registers: Standard Byte Register (STB) Standard Event Status Register (ESR) Error Queue Pending OPC operations
Example (classic)	Sent: "*CLS" Reply: none

*ESE	
Purpose	Read or set the Standard Event Status Enable Register.
Command	"*ESE <i>n</i> "
Query	"*ESE?"
Default	"*ESE 0"
Arguments	<i>n</i> : '0 to 255' This is the decimal representation of the bit(s) to enable. To enable the PON and QYE bits, the argument would be 128 + 4 = 132.
Remarks	The Standard Event Status Enable register determines which bits in the standard Event Status Register are enabled and included in the Status Byte Register (ESB bit), and can assert the SRQ line. The reply is in decimal numeric form.
Example (enhanced)	Sent: "*ESE=128" (enables the PON bit) Query reply: "128" (no reply if IEEE-488)
Errors	ERR# 6: <i>n</i> is not valid.

*ESR	
Purpose	Read the Standard Event Register.
Command	"*ESR?"
Remarks	The Standard Event Register contents are cleared after reading. The reply is in decimal numeric form.
Example (enhanced)	Sent: "*ESR?" Reply: "20" (the QYE and EXE bits are set)

*IDN	
Purpose	Identify the PPC4E versions, range, and serial number.
Query	"*IDN?"
Remarks	The identification reply is made up of the following comma delimit fields: Manufacturer The product model Serial number of the PPC4 Serial number of the HI pressure RPT Serial number of the LO pressure RPT ('0' if not installed) PPC4E software version. CPU board logic version Main board logic version.
Example (enhanced)	Sent: "*IDN?" Reply: "DH INSTRUMENTS INC, PPC4E, 123,100951,63041, Ver1.00E, 1.00a,1.00a"

*OPC	
Purpose	Sets the operation complete bit when all operations have completed.
Command	"*OPC"
Query	"*OPC?"
Remarks	This Command enables the PPC4E to set the OPC bit in the Standard Event Status Register when it has completed all pending functions. The Query replies with a "1" when all functions are complete.
Example (enhanced)	Sent: "*OPC" Query reply: "1"

*OPT	
Purpose	Reads the list of installed PPC4E options.
Query	"*OPT?"
Remarks	This Query returns any registered option(s) installed in the PPC4. Each option is separated by a comma. If there are no options installed, the reply will be "NONE" Possible options: "IEEE-488:0" The IEEE-488 option is installed. "GUI" Indicates PPC4-gui with an LCD
Example (enhanced)	Sent: "*OPT?" Reply: "IEEE-488:0, GUI" Reply: "NONE" (no options installed)

*RST	
Purpose	Resets the PPC4E control settings to factory settings.
Command	"*RST"
Remarks	This Command sets the PPC4E settings to factory settings. This equivalent to a front panel executed RESET/SET. This does not affect the communications settings.
Example (enhanced)	Sent: "*RST" Reply: "*RST" (no reply if IEEE-488)
See Also	Section 3.5.4.1, Reset - Sets

*SRE	
Purpose	Read or set the Service Request Enable Register.
Command	"*SRE <i>n</i> "
Query	"*SRE?"
Default	"*SRE 0"
Arguments	<i>n</i> : '0 to 255' This is the decimal representation of the bit(s) to enable. To allow the MAV and ESB bits to assert the SRQ line, the argument would be 32 + 16 = 48. Bit 6 (64) is reserved and cannot be set.
Remarks	The Service Request Enable Register determines which bits of the Status Byte can set the MSS bit of the Status Byte and request service by asserting the SRQ line of the IEEE-488 interface.
Example (enhanced)	Sent: "*SRE=48" (enables the MAV and ESB bits) Query reply: "48" (no reply if IEEE-488)
Errors	ERR# 6: <i>n</i> is not valid.

*STB	
Purpose	Read the Status Byte Register.
Command	"*STB?"
Remarks	The Status Byte Register reflects the general status of the PPC4. The 'MSS' bit state is represented by bit 6.
Example (enhanced)	Sent: "*STB?" Reply: "80" (The MSS and MAV bits are set)

*TST	
Purpose	Read the power on self test status.
Query	"*TST?"
Remarks	The PPC4E system memory stores the user settings (units, resolution, generation settings) and retains them when the unit is OFF. On power-up, this memory is checked. If this memory is corrupted, all user settings are reset to default (as if the "*RST" program message was executed), and the *TST query will return a non zero value. If the PPC4E passed the test on power-up OR if the *TST query was used at least once since the PPC4E was powered up the reply will be a '0'.
Example (enhanced)	Sent: "*RST?" Reply: "1"

*RSE	
Purpose	Read or set the Ready Status Enable Register.
Command	"RSE <i>n</i> "
Query	"RSE?"
Default	"RSE 0"
Arguments	<i>n</i> : '0 to 255' This is the decimal representation of the bit(s) to enable. To enable the RDY bit, the argument would be 1.
Remarks	The Ready Status Enable Register determines which bits in the Ready Status Register are enabled and included in the Status Byte Register (RSR bit), and can assert the SRQ line. The reply is in decimal numeric form.
Example (enhanced)	Sent: "*RSE=1" (enables the RDY bit) Query reply: "1" (no reply if IEEE-488)
Errors	ERR# 6: <i>n</i> is not valid.

*RSR	
Purpose	Read the Ready Status Register.
Command	"RSR?"
Remarks	The Ready Status Register contents are cleared after reading. The reply is in decimal numeric form.
Example (enhanced)	Sent: "RSR?" Reply: "6" (The MEAS and NRDY)

6. Maintenance, Adjustments and Calibration

6.1 Overview

PPC4E was designed for low maintenance operation. No regular maintenance is required other than:

- Periodic calibration of reference pressure transducers (see Section 6.2).
- Adjustment of the on-board barometer (see Section 6.3).
- Automated adjustment of pressure controlling parameters, as needed (see Section 3.2.12).

This section provides information on maintenance, adjustment and calibration procedures, and recommended overhaul procedures.

⚠ Caution

PPC4E is a sophisticated pressure setting and measuring instrument with advanced on-board features and functions. Before assuming that unexpected behavior is caused by a system defect or breakdown, use this manual and other training facilities to become thoroughly familiar with PPC4E operation. For rapid assistance in specific situations use the troubleshooting guide in Section 7.

Note

PPC4E is covered by a limited one (1) year warranty. Unauthorized service or repair during the warranty period is undertaken at the owner's risk and may cause damage that is not covered under warranty and/or may void the warranty.

6.2 Calibration of Reference Pressure Transducers

6.2.1 Principle

PPC4E may be equipped with one or two reference pressure transducers that are the source of low uncertainty pressure measurement for the system.

To calibrate a PPC4E reference pressure transducer (RPT), pressures from a reference pressure standard are applied to the RPT at ascending and descending points over the range. The pressure defined by the reference and the corresponding RPT readings are recorded at each point. After all of the pressures have been applied and recorded, adjustments are made to fit the RPT pressure readings to the reference. Fitting the readings means performing a linear regression to arrive at the lowest value of the residuals of errors of the RPT relative to the reference. The RPT output is adjusted by user settable coefficients: PA (an adder or offset) and PM (a multiplier or span adjustment) (see Section 6.2.1.1).

A calibration process is performed on each RPT to arrive at its optimal fit.

Note

CalTool for RPTs software provided with the PPC4E supports the calibration process of PPC4E RPTs. CalTool and its documentation are provided on a General Accessories Disk with the new PPC4E. Most users should use CalTool software to assist in the calibration of PPC4E.

PPC4E is delivered with an interactive RPT calibration utility that features the capability to step the operator through the complete RPT calibration procedure, including applying the necessary pressures, collecting data automatically, calculating new PA and PM values,

previewing the results of the new calibration and activating the results of the new calibration (see the CalTool for RPTs manual on the General Accessories Disk). PPC4E also provides complete front panel and remote access to RPT calibration parameters so that RPT calibrations can be performed without using CalTool software (see Section 6.2.8).

6.2.1.1 PA and PM Coefficients

Note

To preserve as received condition in PPC4EX, the Hi RPT must be calibrated before the Lo RPT coefficients are adjusted.

The coefficients used to adjust RPT readings are designated PA (an adder or offset) and PM (a multiplier or span set). The coefficients affect the RPT reading following:

$$\text{Corrected reading} = (\text{Uncorrected reading} \cdot \text{PM}) + \text{PA}$$

PA is expressed in units of pressure (always the SI unit, Pascal).

PM is dimensionless.

Each RPT has its own unique PA and PM values. The PA and PM values currently in use can be viewed and edited in the Calibration function (see Sections 6.2.1.2.1 and 5.4.4 PCAL). PA and PM values are automatically edited when CalTool software is used and the results are activated.

⚠ Caution

As editing PA and PM values will change RPT calibration, they should only be edited by qualified personnel as part of the calibration process. Caution should be taken to avoid accidental editing and a security system is available to prevent access (see Section 3.2.24.5). Incorrect editing of PA and PM values can cause out of tolerance measurements.

Note

A new PPC4E is delivered with PA and PM values set to zero and 1 for all RPTs. This does not mean that the PPC4E has not been calibrated. In the original factory calibration, privileged factory coefficients are used for calibration with the user PA and PM set to zero and 1.

6.2.1.2 As Received and As Left Data

Frequently, calibration procedures require that as received (data collected before the instrument is adjusted) and as left data (data collected after adjustment) be reported. The necessary information to report as received and as left data on the calibration of PPC4E RPTs can be obtained in several ways.

When the PPC4E CalTool calibration assistance software is used, as received data is displayed while running the calibration and is automatically recorded and provided if desired. As left data is also calculated and presented.

At any time, a) reference pressures applied, b) associated transducer readings, c) PA and PM and P_{offset} values can be used to calculate as received and as left values. For example, backing out PA and PM on the as left data yields the transducer readings with PA = 0 and PM = 1. Then applying the as received PA and PM and P_{offset} values to the readings calculates *as received* readings (the readings that the transducer would have made with the old PA, PM and P_{offset}).

Note

- It is recommended that “as received” values of PA, PM and P_{offset} (for absolute mode calibrations) be recorded for each RPT prior to running the calibration.
- To preserve as received condition in PPC4EX, the Hi RPT must be calibrated before the Lo RPT coefficients are adjusted.

6.2.1.2.1 Accessing Calibration Coefficients

The current PA, PM and Poffset values can be viewed by using [\[Settings\]](#), [<More >>>](#), [<Calibration>](#). From this screen either the Hi RPT, Lo RPT or Barometer may be viewed.

For both Hi and Lo RPT, using [<Calibration>](#) displays Cal Date, PA, PM and Poffset if applicable.

Using [Barometer](#) shows the Barometer screen, displaying Cal Date, PA, PM and the current Barometer reading.

Note

If the security level is set to Low or High viewing the calibration coefficients is allowed but no changes are accepted. A warning is displayed when entering and exiting secure screens.

6.2.2 Equipment Required

Note

The recommended calibration standards for PPC4E RPTs are DHI PG7000 gas operated piston gauges (PG7102, PG7202, PG7601) and DHI FPG8601 force-balance piston gauge. Contact Fluke Calibration for additional information.

Gas operated piston gauge (deadweight tester), with the following characteristics:

- **Measurement uncertainty of ± 0.005 % of span.** A reference with greater measurement uncertainty may be used but PPC4E measurement uncertainty may be degraded proportionally from published specifications.
- **If the PPC4E is to be used in absolute or differential gauge pressure measurement modes, the reference standard must be able to apply absolute pressures:** Absolute pressures may be achieved either by operation relative to an evacuated bell jar or, for higher pressures, by addition of atmospheric pressure measured by a high accuracy barometer. **RPTs that will not be used only in gauge pressure measurement mode (as is very often the case for higher pressure RPTs) do not require the application of absolute pressure for calibration and may be calibrated using a gauge pressure reference.**

⚠ Caution

RPTs calibrated in gauge measurement mode by applying gauge reference pressure values should be used in gauge mode only (see Sections 3.2.10, 0), or calibration may be invalid for the measurements made by the PPC4E.

- **Able to supply the recommended sequence of pressure points in the range to be calibrated:** See Section 6.2.4 for information on the recommended calibration point sequence for each PPC4E model.

6.2.3 Set-up and Preparation

To set-up and prepare the PPC4E for calibration of an internal RPT:

- ❶ Set the PPC4E on a stable surface near the calibration standard at a height as close as possible to the calibration standard's reference height. Consider the connections that may need to be made to the rear panel and access to the front panel display and keypad.
- ❷ Connect a pressure supply greater than the maximum pressure to be applied during the calibration to the PPC4E rear panel **SUPPLY** port (1/8 in. NPT F). (See Section 2.3.4)
- ❸ If the calibration will include pressures under atmospheric pressure, connect a vacuum pump to the PPC4E rear panel **EXHAUST** port (1/4 in. NPT F). There will be a constant bleed of gas through the **EXHAUST** port so the vacuum pump should be self-venting or disconnected when OFF (see Section 2.3.5).
- ❹ Connect the calibration standard output to the PPC4E rear panel **TEST(+)** port (1/8 in. NPT F).

⚠ Caution

DO NOT apply pressure to the TEST(+) port without having a pressure supply greater than the applied pressure connected to the SUPPLY port. Do not cause sudden external pressure changes. Damage to internal PPC4E components could result. Unless the piston gauge used to calibrate the PPC4E has automated pressure control, it is highly recommended that the PPC4E direct pressure control keys (see Section 3.2.1) be used to slew and adjust pressure during the calibration. This will minimize the risk of accidental overpressure of the PPC4E RPTs.

6.2.4 Recommended Calibration Point Sequence

Calibration adjustments to PPC4E RPTs are made by adjusting calibration coefficients, PA and PM (see Section 6.2.1.1). To adjust these coefficients to optimum values giving the best results over the RPTs complete operating range, specific calibration point sequences are recommended.

Prior to running the calibration point sequence, the RPT should be exercised by:

- a) Setting full scale pressure.
- b) Dwelling at full scale pressure for 1 minute.
- c) Returning to the lowest pressure being tested.
- d) Dwelling for 1 minute.
- e) Repeat steps a) through d) twice for a total of three pressurization sequences.

A dwell time after setting the pressure of at least 60 seconds before taking data at each point is recommended.

Section **Error! Reference source not found.** gives calibration point sequences.

Note

It is not required that the calibration pressure standard apply precisely the nominal pressure value of each calibration point as long as the exact value of the applied pressure is known. Best results are obtained if the actual applied pressure is within 2 % of the nominal point definition.

6.2.4.1 Recommended Calibration Point Sequences for PPC4E RPTs

See additional information in Section 6.2.4 concerning exercising the RPT and dwell time at pressure points. The recommended calibration point sequence depends on the RPT (HI or LO) and the PPC4E model. See Table 1 for a list of RPTs in each PPC4E model.

Note

The nominal range of each RPT is given by the RPT designation. A prefix of "A" indicates absolute pressure range. A prefix of "BG" indicates bi-directional gauge. The nominal

range is either in kPa or MPa. Thus an A200K is an absolute RPT with a range of 200 kPa. The BG15K is unique and has a range of ± 15 kPa in negative gauge mode.

Table 23. Calibration Point Sequence, A200K RPTs

CALIBRATION SEGMENT	POINT NO.	POINT [% OF SPAN]
Ascending	1	100%
	2	75 %
	3	50 %
	4	25 %
	5	Lowest Pressure ¹
Descending	6	25 %
	7	50 %
	8	75 %
	9	100%

¹ In absolute mode, the lowest point that can be set reliably by the reference piston gauge for low range RPTs.

Table 24. Calibration Point Sequence, A1.4M and A700K RPTs

CALIBRATION SEGMENT	POINT NO.	POINT [% OF SPAN]
Ascending	1	Lowest Pressure ¹
	2	25 %
	3	50 %
	4	75 %
	5	100%
Descending	6	75 %
	7	50 %
	8	25 %
	9	Lowest Pressure ¹

¹ In absolute mode, the lowest point that can be set reliably by the reference piston gauge for low range RPTs.

Table 25. Calibration Point Sequence, A7M and A14M RPTs

CALIBRATION SEGMENT	POINT NO.	POINT [% OF SPAN]
Ascending	1	ATM ¹
	2	25 %
	3	50 %
	4	75 %
	5	100%
Descending	6	75 %
	7	50 %
	8	25 %
	9	ATM ¹

¹ Atmospheric pressure in absolute by addition of ATM mode.

Table 26. Calibration Point Sequence, BG15K RPTs

CALIBRATION SEGMENT	POINT NO.	POINT [% OF SPAN] ¹
Ascending	1	0 %
	2	25 %
	3	50 %
	4	75 %
	5	100 %
Descending	6	75 %
	7	50 %
	8	25 %
	9	0 %

¹ The 15K span is - 15 to + 15 kPa, 30 kPa total. Therefore, 0 % is - 15 kPa, 25 % is - 7.5 kPa, 100 % is + 15 kPa, etc.

Note

Because the PPC4E is rangeable (scalable) down to 1% of controller span for PPC4EX models and 10% of controller span for PPC4E models it may be desirable to perform gauge, negative gauge or absolute verifications using the AutoRange that is required by the user.

6.2.5 Turning Off Absolute and Negative Gauge Measurement Modes

○ PURPOSE

To prevent operation in absolute and negative gauge measurement modes.

○ PRINCIPLE

Most PPC4E models offer absolute, gauge and negative gauge pressure measurement modes. In some applications, a PPC4E will frequently used in gauge measurement mode only (see Section 3.2.10). The reference pressure transducers may be calibrated in gauge mode with a reference that applies only gauge pressures. Calibration with an absolute reference is not necessary. However, if calibrated in gauge mode, it is not possible to know if it the PPC4E is in or out of tolerance in absolute and negative gauge modes. To avoid using absolute and negative gauge measurement modes on a PPC4E that is calibrated for gauge mode only, access to absolute and negative gauge modes can be turned ON and OFF.

○

6.2.7 Editing and Viewing RPT Calibration Information

○ PURPOSE

View and/or edit RPT calibration information fields including:

- **The calibration date** – This field is normally used to record the date on which the RPT is calibrated.
- **The value of absolute mode P_{offset} (applies to Hi RPT of PPC4EX models only)** – This value is normally set to zero following absolute measurement mode calibration of the PPC4E.
- **The value of PA** – The pressure adder for the selected RPT (see 6.2.1.1).
- **The value of PM** – The pressure multiplier for the selected RPT (see 6.2.1.1).
- **Gauge measurement modes ON or OFF** – See Section 3.2.10 for complete information on measurement modes. This is set to OFF if RPT was calibrated in gauge mode with a gauge pressure standard (see Section 0).

○ OPERATION

⚠ Caution

As editing PA and PM values will change the calibration of the RPTs, the edit function should only be used by qualified personnel as part of the calibration process. Caution should be taken to avoid accidental editing. A user level security system is available to control access (see Section 3.2.24.5).

Note

- A new PPC4E is delivered with PA and PM values set to zero and 1 for all ranges. This does not mean that the PPC4E has not been calibrated. In the original factory calibration, privileged factory coefficients are used for calibration with the user PA and PM set to zero and 1.
- PA is always in units of Pascal (Pa). PM is dimensionless.

To access the Calibration Coefficients use [\[Settings\]](#), [<More >>>](#), [<Calibration>](#). Hi or Lo RPT PA, PM, Poffset and Cal Date can be viewed and edited by using [\[Settings\]](#), [<More >>>](#), [<Calibration>](#), [<Hi RPT>](#) or [<Lo RPT>](#), [<Calibration>](#).

Cal Date: Enter the Cal Date in year/month/day format (yyyymmdd)

PA: Enter PA in units of Pa

PM: Enter PM (dimensionless)

Gauge Only: **On** to prevent Absolute or Negative Gauge modes (see Section 6.2.5).

Poffset: View P_{offset} for Hi RPT only. Updated automatically when Vented.

[\[OK\]](#) to accept changes and return to the Main Run Screen. [\[Back\]](#) to return to [<Calibration>](#) and make no changes. [\[Esc\]](#) or [ESC](#) to exit to the Main Run Screen and make no changes.

6.2.7.1 RPT Uncertainty

○ PURPOSE

Configure and edit the settings for calculation and display of RPT live uncertainty (see Section 3.2.27).

○ OPERATION

The Uncertainty functions are located in [\[Settings\]](#), [<More >>>](#), [<Calibration>](#), [<Hi RPT>](#) or [<Lo RPT>](#), [<Uncertainty>](#).

6.2.7.1.1 Uncertainty

This screen controls display and type of uncertainty as well as uncertainty in head height.

- Display:** **On** to enable display of live uncertainty in Main Run Screen, **Off** to disable display of uncertainty.
- Type:** **Measured** or **Delivered** (including control components)
- Head Height:** Uncertainty in head height (same units as Head)
- Constant:** Absolute mode zero drift component

[OK] to accept changes and return to the Main Run Screen. [Back] to return to <Calibration> and make no changes. [Esc] or **ESC** to exit to the Main Run Screen and make no changes.

6.2.8 RPT Calibration/Adjustment without CalTool for RPTs Software

○ PRINCIPLE

The PPC4E RPTs can be calibrated and adjustments made without using CalTool for RPTs software. This requires:

- Applying pressures with a calibration standard and recording the pressures measured by PPC4.
- Calculating new PA and PM values and entering them.

⚠ Caution

Before proceeding to calibrate a reference pressure transducer without using CalTool for RPTs software, Sections 6.2.1, 6.2.2 and 6.2.3, Calibration of Reference Pressure Transducers, Equipment Required, Setup and Preparation should be reviewed thoroughly.

○ OPERATION

The typical procedure for calibrating a RPT in a PPC4E is:

- ❶ Set-up and prepare the PPC4E for calibration (see Sections 6.2.2 and 6.2.3).
- ❷ Activate the RPT to be calibrated using [AutoRange], Range to choose the Default Range of the RPT (see Section 3.2.5). Be sure to set the DF range (not an AutoRanged range).
- ❸ Set the Head to zero using [Settings], <Pressure>, Head (see Section 3.2.15). Set the desired pressure unit of measure using [Settings], <Pressure>, Pressure Unit (see Section 3.2.9). Set the desired pressure measurement mode using [Settings], <Pressure>, Measurement Mode (see Section 3.2.10). Axxx (absolute) RPTs that will be used in gauge measurement mode only, may be calibrated in gauge measurement mode with a gauge pressure standard (see Section 6.2.5).
- ❹ Use [Settings], <Calibration>, Hi RPT or Lo RPT, read and record the current values of PA and PM for the RPT to be calibrated. If calibrating in absolute mode, also record the value of P_{offset}.
- ❺ Run the recommended calibration point sequence for the RPT (see Section 6.2.4) recording the pressure applied by the standard and the PPC4E reading at each calibration point. Dwell at least 90 seconds at each point after setting the reference pressure to allow full stabilization before taking data. The data recorded is the “as received” data for this calibration.
- ❻ Enter the calibration pressures and PPC4E readings into a spreadsheet. Calculate the “non-corrected” PPC4E readings by backing out the PA, PM and P_{offset} (P_{offset} only in the case of Axxx (absolute) RPTs in absolute mode) recorded in Step ❹ above, following:

$$\text{non-corrected reading} = ((\text{corrected reading} - \text{PA})/\text{PM}) + \text{P}_{\text{offset}}$$
- ❼ Perform a linear regression to find the offset and slope that best fit the non-corrected PPC4E readings to the calibration standard pressures. The offset is the new value of PA, the slope is the new value of PM.

- ⑥ Use [\[Settings\]](#), [<Calibration>](#), [Hi RPT](#) or [Lo RPT](#) and write the new calibration date and the new values of PA and PM for the RPT and range calibrated. If this is an Axxx Hi RPT then it is not necessary to set Poffset to 0. Poffset will be updated after calibration automatically when the PPC4E is vented. If this is an Axxx RPT and the calibration was performed in gauge mode, turn absolute and negative gauge modes Off to avoid their being used after the calibration by setting [Gauge Only](#) to [On](#) (see Section 6.2.5).
- ⑦ Calculate as left data for the calibration if desired following:

$$\text{as left reading} = (\text{non-corrected reading} \cdot \text{new PM}) + \text{new PA}$$
- ⑩ Perform additional verification pressure runs as desired.

6.3 Adjustment of an On-board Barometer

○ PURPOSE

To adjust the output of the on-board barometer (see Sections 1.2.2.2 and 3.2.25.3).

○ PRINCIPLE

The on-board barometer output can be adjusted using PA and PM values in the same manner as RPTs (see Section 6.2.1.1).

Note

The on-board barometer is a low accuracy sensor used for measuring changes in atmospheric pressure over short periods of time (see Section Error! Reference source not found.) and line pressure for differential RPT line pressure compensation. PPC4E measurement uncertainty does not depend on the measurement uncertainty of the on-board barometer.

○ OPERATION

To edit the values of PA and PM for the barometer, use [\[Settings\]](#), [<Calibration>](#), [Barometer](#). Set the calibration date [\[YYYYMMDD\]](#) and edit PA and PM. With security set to [Off](#), the values can be edited (see Section 3.2.24.5).

[\[OK\]](#) to accept changes and return to the Main Run Screen. [\[Back\]](#) to return to [<Calibration>](#) and make no changes. [\[Esc\]](#) or [ESC](#) to exit to the Main Run Screen and make no changes.

6.4 Pneumatic Control Module Configuration

○ PURPOSE

To run an automated routine that adjusts automated pressure control coefficients or to return automated pressure control coefficients to factory default values.

○ PRINCIPLE

PPC4E uses factory configuration coefficients in the pressure control algorithms used for automated pressure control. Changes in the pressure control elements over time or operation into an unusually large test volume can cause pressure control performance to change. The PPC4E on-board configuration routine automatically retunes the factory configuration coefficients to take these changes into account.

The Configuration function should be considered a maintenance function and only used to attempt to improve pressure control when all other factors affecting pressure control have been examined and eliminated (for example leaks, restrictions in test lines, unstable pressure supply, unstable vacuum supply). The configuration function may also be useful to speed up PPC4E pressure control when the minimum test volume is in excess of 500 cc.

In addition, the Configuration function allows pressure control parameters to be returned to factory default values. This feature can be useful to return to known conditions after the on-board configuration function has been run.

Note

- If the PPC4E is model PPC4E 15K, PPC4E 100K or PPC4EX 100K, the configuration routine should be run twice, once with a vacuum source attached to the EXHAUST port and once without.
- The default AutoRange of the PPC4E Hi RPT must be active for a Configuration to run. (See Section Error! Reference source not found.).

⚠ Caution

Poor control is usually caused by invalid control parameters, excessive leaks and restrictions in the test system or other set up problems. These problems should be identified and eliminated before resorting to use of the configuration function (see Section 7).

To access Control Configuration use **[Tools], <System>, Control Configuration**.

Set Default causes PPC4E to load factory default control coefficients. This feature can be useful to return to standard conditions if a faulty Configuration routine has been activated or the current configuration is no longer valid.

Before running a Configuration, remove any external volume and plug the TEST(+) port. However, if there is a minimum anticipated test volume, for example, if a DVU is to be used with PPC4E 15K or PPC4EX 100K (see Section 2.3.6.2), leave the volume connected. Connect the normal supply pressure to the rear panel SUPPLY port and perform a leak check.

To perform a Vacuum Configuration, connect a vacuum pump to the EXHAUST port. If the Control Reference (see Section 3.2.25.2) is not **Vacuum** an error will be displayed.

To perform an Ambient Configuration, make sure there is no vacuum applied to the EXHAUST port. If the Control Reference (see Section 3.2.25.2) is not **Atmosphere** an error will be displayed.

This display warns the user that pressure will increase to roughly 50% of the Hi RPT default range. **[Yes]** to continue if it is safe for PPC4E to set the indicated pressure.

<Running Vacuum configuration> or **<Running ATM configuration>** flashes above a progress bar while the PPC4E pulses and slews pressure. After about ten minutes, the user is asked whether or not to save the new configuration. **[Yes]** if the CONFIG function ran completely and without incident. **[No]** to return to the Main Run Screen with no change to the pressure control coefficients.

If the PPC4E is PPC4E 15K, PPC4E 100K or PPC4EX 100K, repeat the configuration routine in the other operating mode. If you never use the PPC4E in one of the two conditions, it is not necessary to configure it in that condition.

⚠ Caution

- The configuration routine must be run with **NO** external volume connected to the PPC4E (TEST(+) port plugged) unless a known minimum test volume is always connected. After configuring with a volume connected to the TEST(+) port, controlling pressure with a lower volume may result in poor pressure control.
- The effect of the CONFIG function can be eliminated and control coefficients returned to factory defaults by using **[Tools], <Control Configuration>, Set Default**.

6.5 Reloading Embedded Software into Flash Memory

PPC4E uses FLASH memory. This allows the embedded software that controls PPC4E operations and functions to be loaded into PPC4E over its COM1 port or front panel USB port from a computer with a simple FLASH loading utility program.

⚠ Caution

Only load PPC4E embedded software to the PPC4E. Loading software for Fluke Calibration PPC4E or any other product will fail or cause the unit to not function properly.

6.6 Removing the PPC4E Cover

⚠⚠ Warning

To avoid electric shock, disconnect mains power before removing the top cover.

In order to access the internal components of the PPC4E it is necessary to remove the chassis cover. To do so, first remove the eight screws that are on the top, right and left edges of the back panel. Then, using the two M3 x 20 mm screws in the PPC4E accessory kit, gradually back the cover from the closed and secured position using both screws. Once the cover is moved back by about 10 mm (0.4 inch) then the screws should be removed or retracted and the cover can be lifted off the chassis (see Figure 15).



Figure 15. Removing Back Cover

6.7 Overhaul

Note

If calibration of the reference pressure transducers (RPT) is included as part of the overhaul procedure, the calibration procedure should be performed last.

Any or all of the following items may be included as part of a system maintenance overhaul:

- Disassemble pressure control module filters and clean filter elements. Replace, if necessary.
- Clean front panel.
- Clean threads of rear panel fittings. Check for damage and replace, if necessary.
- Check that rear panel cooling fan operates when PPC4E is On.
- Check that internal screws, bolts and nuts are tight.
- Verify that internal barometer, if present, reads atmospheric pressure within ± 0.1 kPa (0.015 psi). Adjust if necessary (see Section 6.3)
- Verify that utility sensor, if present, indicates pressure with ± 0.1 % FS over its range. Adjust if necessary (see Section **Error! Reference source not found.**).
- Pressurize PPC4E to 90 % of maximum pressure and leak test. Use the Leak Test shortcut from the Main Run Screen (see Section 3.2.17). Leak rate, after stabilization, should not exceed 0.001 % of maximum pressure/ second.
- Check the PPC4E controls within specifications over its range (see Section 1.2.3).
- Perform calibration of RPTs if necessary (see Section 6.2).

6.8 Subassembly Description and Location

⚠⚠ Warning

To avoid electric shock, disconnect mains power before removing the top cover.

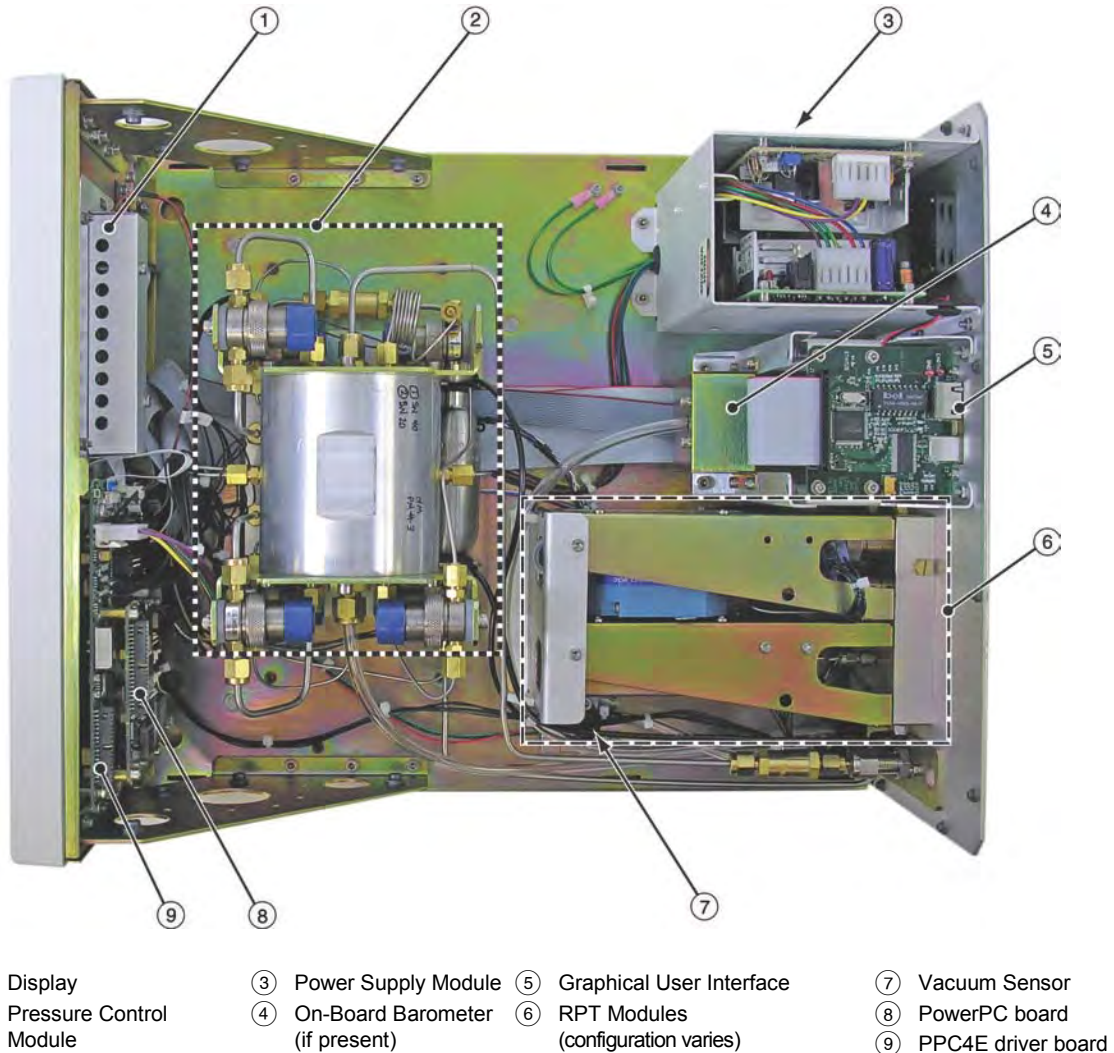

Figure 16. PPC4E Internal View

6.8.1 Power Supply Module

- + 12 V DC ($\pm 2\%$) @ 3.3 Amps: For internal and external valve actuation.
- + 5 V DC ($\pm 1\%$) @ 3.0 Amps; + 15 V DC ($\pm 3\%$) @ 1.5 Amps; - 15 V DC ($\pm 3\%$) @ 0.35 Amps: For the supply of the micro board and driver board electronics.

6.8.2 PowerPC Board

The PowerPC board supports a Motorola PowerPC 8241 processor, EPROM, EEPROM, 128k x 8 bit NVRAM, 64 Mbit flash memory, 256 Mbit SDRAM memory; RS232 communications; and display control. An FPGA controls other ports and devices in PPC4E.

6.8.3 RPT MODULE

The RPT module is an integrated assembly that mechanically manages the PPC4E's pressure transducers. The module includes a Hi RPT (reference pressure transducer) and may also have a Lo RPT (in "PPC4EX" models), brackets to hold the transducer(s) interconnecting tubing, a manifold with the PPC4E's **TEST (-)**, **TEST(+)** and **VENT** ports and solenoid valves for measurement mode changes and switching of the active transducer.

See Figure 18 for pneumatic schematics of different RPT module configurations.

6.8.3.1 Hi RPT

Every PPC4E is equipped with a high range reference pressure transducer (Hi RPT). An RPT is intended to provide very high precision, low uncertainty, traceable pressure measurement. The basic sensing principle is the measurement of the change in the natural oscillating frequency of a quartz tuning fork in response to changes in temperature and mechanical stress resulting from the change in pressure applied to a connecting bellows or bourdon tube. Two independent quartz elements are used. One quartz element is subjected to pressure related stress. The other quartz element is used only to monitor temperature. See Section **Error! Reference source not found.** for PPC4E measurement specifications.

6.8.3.2 Lo RPT

PPC4E models beginning with "PPC4EX" are equipped with a Lo RPT. The Lo RPT provides a lower measurement range than the Hi RPT. See Section 6.8.3.1 for a description of RPTs and Section **Error! Reference source not found.** for complete PPC4E specifications.

Through the PPC4E AutoRange function, the most appropriate RPT for the DUT full scale span and measurement mode will be activated.

6.8.4 On-board Barometer

The on-board barometer supports a board mounted, barometric range, micromachined silicon sensor and an ambient temperature sensor. The barometer readings are used for dynamic atmospheric pressure compensation when measuring gauge pressure with an absolute reference transducer (see Section 3.2.4). The temperature sensor is used for temperature compensation of the barometric sensor.

6.8.5 Vacuum Sensor

The vacuum sensor is a silicon solid state pressure sensor in the barometric range. The vacuum sensor readings are used to determine whether a atmospheric pressure or a vacuum pressure is applied to the PPC4E **EXHAUST** port (see Section 3.2.25.2).

6.8.6 Pressure Control Module

The pressure control module is an integrated assembly that includes two inlet (fast and slow); two exhaust (fast and slow) control valves; vent valve and differential pressure regulators. The differential pressure regulators use pressure feedback to maintain a constant differential pressure across the control valves. The control valves are solenoid type, actuated by 12 V. See Figure 17 for the pneumatic module schematic.

6.8.7 Display

Graphical user interface: 5.7" TFT QVGA LCD (320x240).

6.8.8 Driver Board

The driver board is controlled by the PowerPC board (see Section 6.8.2). It supports:

- 12 V drivers for internal and external solenoid valve actuation
- Frequency counters (4) for RPTs (see Section 6.8.3.1)
- On-board barometer power and output (see Section 6.8.4)
- Vacuum sensor power and output for ControlRef function (see Section 3.2.25.2)
- Power to the system cooling fan
- Keypad and display
- USB, IEEE-488.2 communications
- Beeper

6.9 Pneumatic Schematics

6.9.1 PPC4E Pressure Control Module

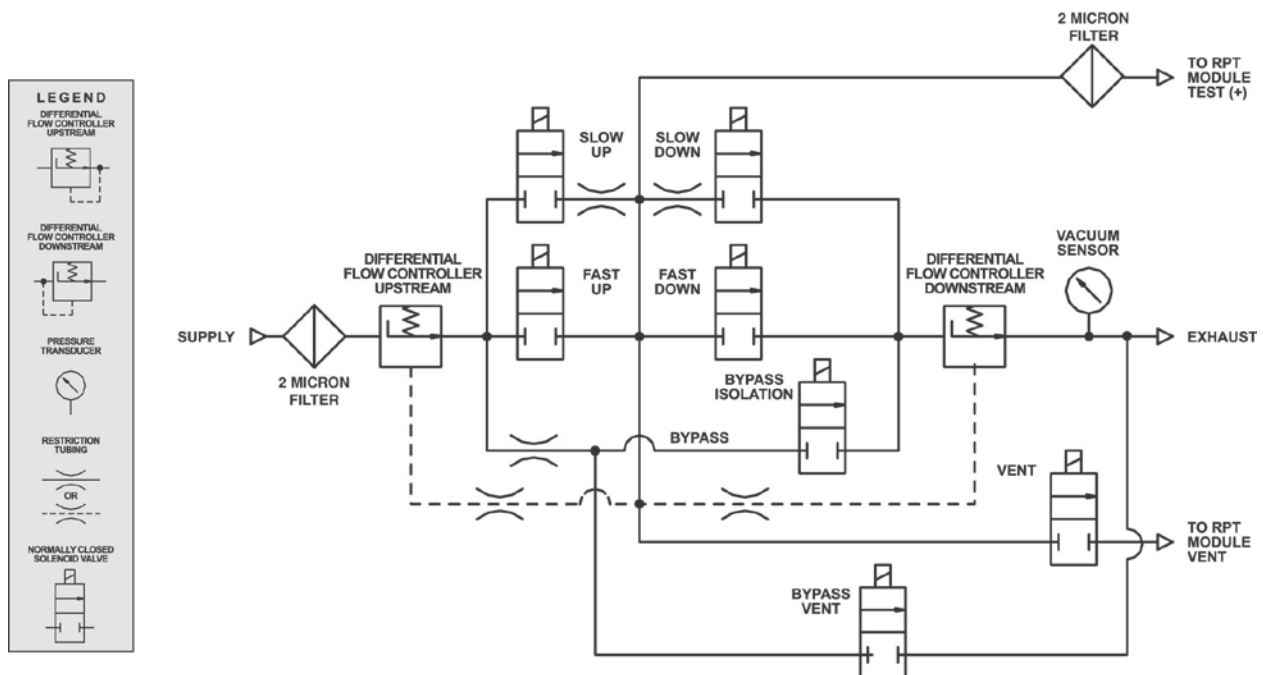

Figure 17. Pressure Control Module Schematic

6.9.2 PPC4E Reference Pressure Transducer Module Configurations

ONE REFERENCE PRESSURE TRANSDUCER: PPC4E 14M

CONDITION	VALVE STATE		
	A	B	C
Vent	O	O	O
Measure/Control	C	O	C
Power off	C	O	C

Valve C is shown for reference. It is in the pressure control module.

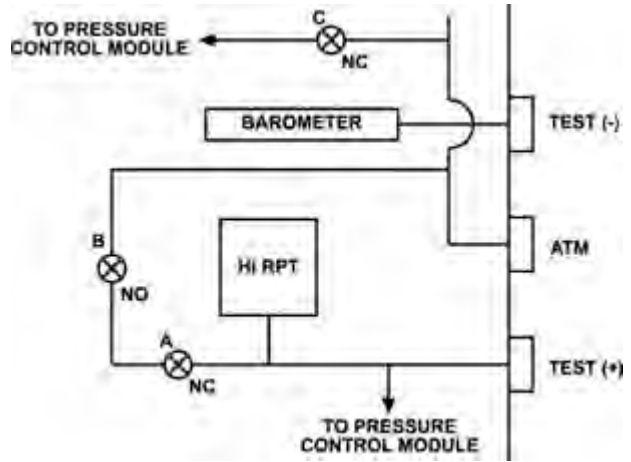

ONE REFERENCE PRESSURE TRANSDUCER: PPC4E 100K, PPC4E 1.4M or PPC4E 7M

CONDITION	VALVE STATE		
	A	B	C
Vent	O	O	O
Measure/Control	O	C	C
Power off	C	O	C

Valve C is shown for reference. It is in the pressure control module.

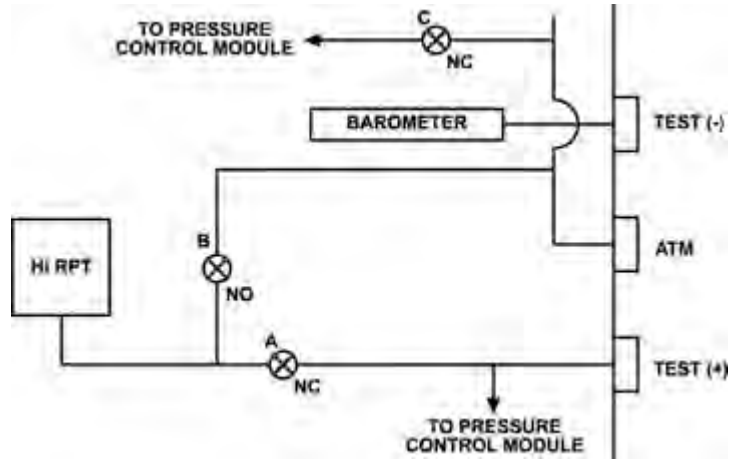

ONE REFERENCE PRESSURE TRANSDUCER: PPC4E 15K

CONDITION	VALVE STATE			
	A	B	C	D
Vent	O	O	O	O
Measure/Control	O	C	O/C	C
Power off	C	O	O	C

Valve C is the TEST (-) vent valve. In normal operation of PPC4E 15K, this valve is closed during fine pressure control (see Section 3.5.7.5).

Valve D is shown for reference. It is in the pressure control module.

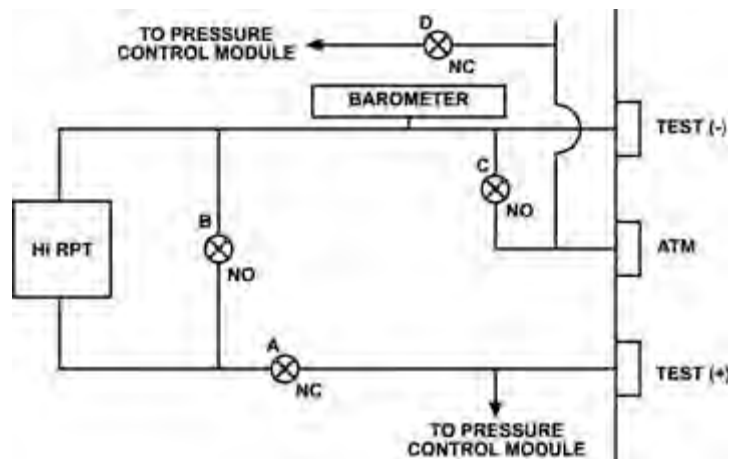

TWO REFERENCE PRESSURE TRANSDUCERS: PPC4EX 1.4M, PPC4EX 7M or PPC4EX 14M

CONDITION	VALVE STATE		
	A	B	C
Vent	O	O	O
Measure/Control Hi	C	O	C
Measure/Control Lo	O	C	C
Power off	C	O	C

Valve C is shown for reference. It is in the pressure control module.

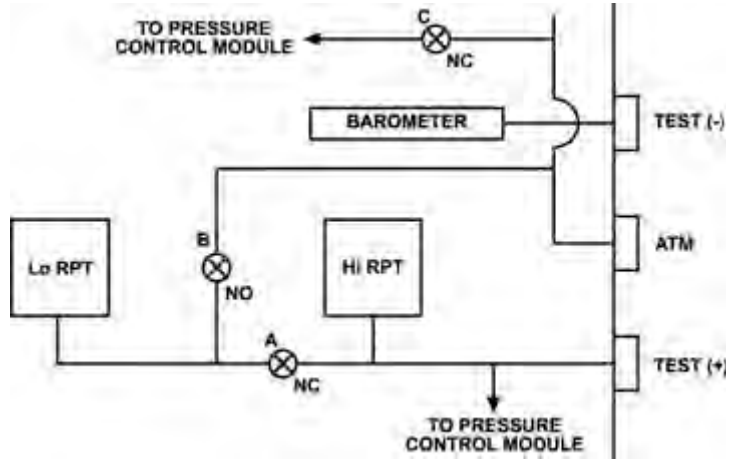

TWO REFERENCE PRESSURE TRANSDUCERS: PPC4EX 100K

CONDITION	VALVE STATE			
	A	B	C	D
Vent	O	O	O	O
Measure/Control Hi	C	O	C/O	C
Measure/Control Lo	O	C	C/O	C
Power off	C	O	O	C

Valve D is shown for reference. It is in the pressure control module.
 Valve C is the TEST (-) vent valve. In normal operation with PPC4EX 100K, this valve is closed during fine pressure control (see Section 3.5.7.5).

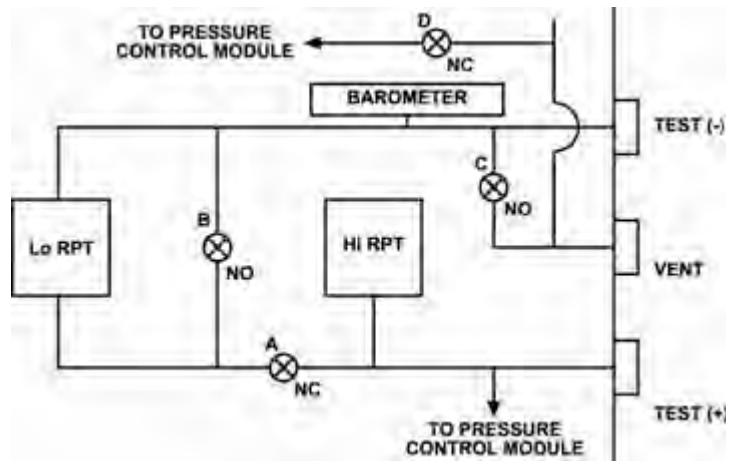

Figure 18. PPC4E Reference Pressure Transducer Module Schematics

7. Troubleshooting

PPC4E is a sophisticated pressure setting and measuring instrument with advanced on-board features and functions. Before assuming that unexpected behavior is caused by a system defect or breakdown, the operator should use this manual and other training facilities to become thoroughly familiar with PPC4E operation. This troubleshooting guide is intended as an aid in identifying the reason for PPC4E behavior and determining whether the behavior is due to normal operation or an internal or external problem.

Identify the symptom or unexpected behavior you are observing from the **SYMPTOM** list below. A **PROBABLE CAUSE** is provided and a **SOLUTION** is proposed including references to manual sections that provide information that may be of assistance.

Table 27. PPC4E Troubleshooting Guide

SYMPTOM	PROBABLE CAUSE	SOLUTION
Will not power up.	Blown fuse.	Replace fuse.
Cannot access certain functions > ACCESS RESTRICTED <	Security level has been set that restricts access to certain functions.	Change user level or consult system manager. 3.2.24.5
Displays < FATAL ERROR > or < FATAL FAULT >.	Encountered unresolved internal software conflict.	Cycle power to clear. Please record conditions leading up to event including the numbers displayed when ENTER is used. Report to your Authorized Service Provider. Error! Reference source not found.
There is a leak through the PPC4E EXHAUST port.	Normal flow through bypass of internal pressure controllers when pressure supply is connected and system is not vented or OFF.	Operation is normal if flow rate is normal. If there is flow through the EXHAUST port when system is vented or OFF, contact Authorized Service Representative. 6.7, 3.2.24.5
Front panel keys seem to be disabled.	< remote > command has been sent from a host computer.	Send < local > command from host computer or cycle PPC4E power. 5, 5.4.4
Valve driver #8 seems to be operating erratically without being told to do so.	Driver #8 is used automatically by the automated purge function when purge is activated.	Deactivate purge function or don't use driver #8 other than to support an SPLIT. 3.2.16
Measured pressure display has too much/not enough resolution.	Resolution setting needs to be changed.	Use Resolution function to change the resolution setting. 3.2.18
Can't increase resolution to level desired in AutoRanged range.	Resolution setting is limited when AutoRanging under 10% of controller span (PPC4E) or 1% of controller span (PPC4EX).	Operation is normal. Table 6
Values that should be non-zero are displayed as zero.	Resolution setting needs to be increased to view significant digits.	Use Resolution function to change the resolution setting. 3.2.18
Front panel is blank with moving pressure or logo	Screen saver option has activated.	Operation is normal. Press any key to resume full screen power. Adjust screen saver time, if desired. 3.2.24.1
Pressure display is flashing and beeper is sounding intermittently.	Current upper or lower limit of active range has been exceeded.	Correct overpressure condition. Change UL and/or active range if needed. 3.2.20, 3.2.20.1
Pressure display is flashing, no beeper is sounding and direct pressure control keys are inactive.	PPC4E has been over-pressured.	Correct the overpressure condition and cycle power ON and OFF. 3.2.20.1
A <i>Ready</i> (green <i>Ready/Not Ready</i> indicator) indication is never achieved.	Control parameter settings are too tight and/or existing conditions will not allow <i>Ready</i> to be achieved.	Adjust control parameters or correct other conditions. 3.2.3, 3.2.11
Cannot select absolute measurement mode.	If model is PPC4E 15K, absolute measurement mode is not available.	Operation is normal. 3.2.10
Cannot select absolute or negative gauge measurement mode.	Absolute and negative gauge measurement modes have been turned off in the calibration function.	Check that absolute/negative gauge is ON. 6.2.5

SYMPTOM	PROBABLE CAUSE	SOLUTION
Will not accept pressure command.	Target exceeds UL and/or current range.	Check UL, range and measurement mode. 3.2.20, Error! Reference source not found. , 3.2.10
Will not set pressure.	Pressure and/or vacuum supply incorrectly connected or not adequate.	Correct pressure and/or vacuum supply. 2.3.4, 2.3.5
	There is a very large leak in the test system or TEST(+) port is not connected.	Correct leak. 2.3.8, 3.2.17
Will not set negative gauge pressure.	Measurement mode is not negative gauge.	Set negative gauge mode if supported by RPT. 3.2.10
Poor pressure control at low gauge pressure.	Vacuum source on EXHAUST port is needed.	Connect vacuum source to EXHAUST port. 2.3.5
	Ambient (atmospheric pressure) is too noisy and/or not consistent on TEST (-) port and UUT.	Connect TEST (-) ports of PPC4E and UUT together and consider isolating from atmospheric pressure. 2.3.6, 2.3.7
Poor pressure control at low gauge and/or absolute pressure.	ControlRef not properly set to reflect pressure conditions at EXHAUST port.	Set Control Reference properly. 3.2.25.2
Poor pressure control at very low gauge pressure.	DVU is needed, particularly if the model is PPC4E 15K or PPC4EX 100K.	Install DVU on TEST(+) and TEST (-) ports. 2.3.6.2
Poor pressure control at pressures under atmosphere or inability to reach pressures under atmosphere.	Vacuum supply is incorrectly connected, is not low enough or is unstable.	Correct vacuum supply to EXHAUST port. 2.3.5
Poor pressure control characterized by control interrupting near the target pressure.	Control mode is set to static mode rather than dynamic mode.	Set control mode to dynamic. 3.2.2, 3.2.11
Poor pressure control characterized by excessive overshooting/undershooting and/or "hunting" around target.	There is a restriction in the test connection between the PPC4E and the test. Restrictions are particularly problematic at low absolute pressures.	Remove the restriction to allow free flow between the PPC4E and the test. 2.3.6
	Pneumatic control module needs to be reconfigured.	Reconfigure control module after all other possible control issues are considered. 6.4
	The volume connected to the TEST(+) port is too small.	Add volume to the system connected to the TEST(+) port. 1.2.3
	A filter in the PPC4E, the SPLT or an accessory is dirty and causing a restriction.	Clean and dry or replace the filter element.
	Excessive leak present in system.	Correct internal or external leak or increase hold limit. 3.2.17, 3.2.12
	Test volume too small.	Increase test volume. Consider use of DVU (Dual Volume Unit) if model is PPC4E 15K or PPC4EX 100K. Consider reconfiguration of pneumatic module after all other possible control issues have been evaluated. 2.3.6.2, 6.4
Poor pressure control characterized by minor overshooting.	Some overshooting is part of normal operation to speed up pressure stabilization.	Check whether overshooting is within normal limits. Objectively evaluate significance of overshoot relative to UUT span and specifications. Increase test volume.
Poor pressure control characterized by very slow slew rate.	Test volume is too large. Severe restriction in a test line.	Reduce test volume if slew rate is unacceptable. Remove restrictions in line connected to TEST(+) port.
Poor pressure control.	Unstable or incorrect pressure supply.	Connect regulated pressure supply set to correct supply pressure to SUPPLY port. 2.3.4
Poor pressure control and measurement.	The PPC4E and/or the connection to the test system are contaminated with liquids.	Purge and clean affected systems. Consider use of Self-Purging Liquid Trap. Contact Authorized Service Provider if PPC4E is contaminated internally. 2.3.6.1, Error! Reference source not found.
Apparent inaccurate pressure control/measure and little or no response from PPC4E reference pressure transducer	Reference transducer destroyed by overpressure.	Contact Authorized Service Provider. Error! Reference source not found.

SYMPTOM	PROBABLE CAUSE	SOLUTION
Apparent inaccurate pressure measurement/control.	Incorrect pressure units and/or measurement mode (gauge or absolute).	Set desired pressure units and/or measurement mode. Consider reference temperature if unit is xxH ₂ O. 3.2.9, 3.2.10
	Reference pressure transducer calibration coefficients have been altered.	Check and correct calibration coefficients if needed. Consider calibration or verification of PPC4E. 6.2
Will not vent.	System is vented but does not indicate zero because measurement mode is absolute.	Check measurement mode setting and current value of atmospheric pressure if absolute. 3.2.10
	VENT port is plugged.	Open VENT port to atmosphere.
	Vent valve not operating.	Contact Authorized Service Provider. Error! Reference source not found.
Will not vent while purging. Stuck at pressure during purging.	Purge function is not activated, Purge function is activated but no SPLT is connected or SPLT valve is not operating.	Activate SPLT; correct SPLT connection or repair SPLT exhaust valve. 3.2.25.4, 2.3.6.1

8. Appendix

8.1 Drivers

The PPC4E drivers output provides eight open collector drivers for operating external valves, solenoids, indicators, etc.

Each driver outputs 12 V, however the current sinking capacity of each driver is different. Refer to Table 28 for the maximum current of each driver. The total current for all the activated drivers cannot exceed 2 Amps.

Table 28. External Drivers Current Output

DRIVER NUMBER	MAX CURRENT [mA]
1	1 000
2	500
3	500
4	200
5	160
6	135
7	120
8	100

The male connector (P/N 3069838) for the **DRIVERS** port is delivered with the PPC4E accessories.

Table 29 and Figure 19 should be referred to when building a cable to utilize the drivers port.

Table 29. External Drivers Pin Outs

EXTERNAL DRIVERS		
PIN	DESCRIPTION	
A	D1	Driver #1 (Open Collector)
C	D2	Driver #2 (Open Collector)
E	D3	Driver #3 (Open Collector)
G	D4	Driver #4 (Open Collector)
M	D5	Driver #5 (Open Collector)
J	D6	Driver #6 (Open Collector)
K	D7	Driver #7 (Open Collector)
L	D8	Driver #8 (Open Collector)
B		Drivers (+ 12 V)
D		Drivers (+ 12 V)
F		Drivers (+ 12 V)
H		Drivers (+ 12 V)

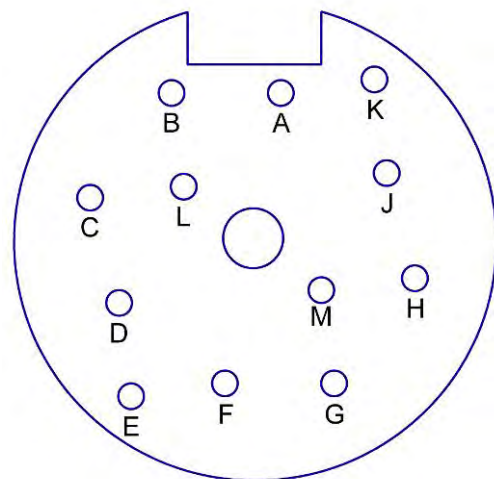

Figure 19. Drivers Connector Schematic

8.2 Unit Conversion

8.2.1 Pressure

PPC4E performs all internal calculations in SI units. Numerical values input or output in other units are converted to SI immediately after entry and back to other units just before output as needed.

Table 30 provides the conversion coefficients used by PPC4E to convert numerical values expressed in SI units to corresponding values expressed in other units.

Table 30. Pressure Unit of Measure Conversion Coefficients

TO CONVERT FROM Pa To		MULTIPLY BY
Pa	<i>Pascal</i>	1.0
mbar	<i>millibar</i>	1.0 E-02
hPa	<i>hecto Pascal</i>	1.0 E-02
kPa	<i>kilo Pascal</i>	1.0 E-03
bar	<i>bar</i>	1.0 E-05
mmH2O @ 4°C	<i>millimeter of water at 4°C</i>	1.019720 E-01
mmH2O @ 20°C	<i>millimeter of water at 20°C</i>	1.019716 E-01
mmH2O @ 60°F	<i>millimeter of water at 60°F</i>	1.018879 E-01
mH2O @ 4°C	<i>meter of water at 4°C</i>	1.019720 E-04
mH2O @ 20°C	<i>meter of water at 20°C</i>	1.019716 E-04
mH2O @ 60°F	<i>meter of water at 60°F</i>	1.018879 E-04
mmHg @ 0°C	<i>millimeter of mercury</i>	7.50063 E-03
psi	<i>pound per square inch</i>	1.450377 E-04
psf	<i>pound per square foot</i>	2.0885429E-02
inH2O @ 4°C	<i>inch of water at 4°C</i>	4.014649 E-03
inH2O @ 20°C	<i>inch of water at 20°C</i>	4.021732 E-03
inH2O @ 60°F	<i>inch of water at 60°F</i>	4.018429 E-03
inHg @ 0°C	<i>inch of mercury</i>	2.953 E-04
kcm ²	<i>kilogram force per centimeter square</i>	1.019716 E-05
mTorr	<i>milliTorr (micron of mercury)</i>	7.50063
Torr	<i>Torr (millimeter of mercury)</i>	7.50063 E-3
user	<i>User</i>	User defined coefficient
ft	<i>feet of altitude</i>	see Altitude Note below
m	<i>meter of altitude</i>	see Altitude Note below

Altitude Note: Quantities expressed in units of altitude follow MIL-STD-859A "Static Pressure, p, in Inches of Mercury for Values of Pressure Altitude, H, in Geopotential Feet." MIL-STD-859A provides tables of pressure in inches of mercury as a function of altitude in feet. PPC4E uses a set of equations to model the pressure/altitude relationship. The worst case deviation between the MIL-STD-859A table and the calculated pressure is 0.0001 inches of mercury (0.3 Pa). The pressure quantity expressed in inches of mercury is converted to Pascal following Table 30 above. For altitude expressed in meters, meters are converted to feet using 1 m = 3.28084 ft.

9. Limited Warranty and Limitation of Liability

Each Fluke product is warranted to be free from defects in material and workmanship under normal use and service. The warranty period is one year and begins on the date of shipment. Parts, product repairs and services are warranted for 90 days. This warranty extends only to the original buyer or end-user customer of a Fluke authorized reseller, and does not apply to fuses, disposable batteries or to any product which, in Fluke's opinion, has been misused, altered, neglected, contaminated, or damaged by accident or abnormal conditions of operation or handling. Fluke warrants that software will operate substantially in accordance with its functional specifications for 90 days and that it has been properly recorded on non-defective media. Fluke does not warrant that software will be error free or operate without interruption.

Fluke authorized resellers shall extend this warranty on new and unused products to end-user customers only but have no authority to extend a greater or different warranty on behalf of Fluke. Warranty support is available only if product is purchased through a Fluke authorized sales outlet or Buyer has paid the applicable international price. Fluke reserves the right to invoice Buyer for importation costs of repair/replacement parts when product purchased in one country is submitted for repair in another country.

Fluke's warranty obligation is limited, at Fluke's option, to refund of the purchase price, free of charge repair, or replacement of a defective product which is returned to a Fluke authorized service center within the warranty period.

To obtain warranty service, contact your nearest Fluke authorized service center to obtain return authorization information, then send the product to that service center, with a description of the difficulty, postage and insurance prepaid (FOB Destination). Fluke assumes no risk for damage in transit. Following warranty repair, the product will be returned to Buyer, transportation prepaid (FOB Destination). If Fluke determines that failure was caused by neglect, misuse, contamination, alteration, accident or abnormal condition of operation or handling, including overvoltage failures caused by use outside the product's specified rating, or normal wear and tear of mechanical components, Fluke will provide an estimate of repair costs and obtain authorization before commencing the work. Following repair, the product will be returned to the Buyer transportation prepaid and the Buyer will be billed for the repair and return transportation charges (FOB Shipping Point).

THIS WARRANTY IS BUYER'S SOLE AND EXCLUSIVE REMEDY AND IS IN LIEU OF ALL OTHER WARRANTIES, EXPRESS OR IMPLIED, INCLUDING BUT NOT LIMITED TO ANY IMPLIED WARRANTY OF MERCHANTABILITY OR FITNESS FOR A PARTICULAR PURPOSE. FLUKE SHALL NOT BE LIABLE FOR ANY SPECIAL, INDIRECT, INCIDENTAL OR CONSEQUENTIAL DAMAGES OR LOSSES, INCLUDING LOSS OF DATA, ARISING FROM ANY CAUSE OR THEORY.

Since some countries or states do not allow limitation of the term of an implied warranty, or exclusion or limitation of incidental or consequential damages, the limitations and exclusions of this warranty may not apply to every buyer. If any provision of this Warranty is held invalid or unenforceable by a court or other decision-maker of competent jurisdiction, such holding will not affect the validity or enforceability of any other provision.

10. Glossary

Absolute Mode	Measurement mode in which the PPC4E indicates absolute pressure (difference from vacuum).
AutoRange	A function that optimizes PPC4E measurement and control for a specific, user defined range of operation.
AutoRanged Range	A PPC4E range created using the AutoRange function.
AutoTest or ATest	PPC4E on-board automated testing sequences and their results.
Barometer	PPC4E on-board atmospheric pressure measuring sensor. Also referred to as on-board barometer.
Bi-directional Gauge	Measurement mode in which the PPC4E indicates gauge pressure (difference from atmospheric pressure), in both positive and negative directions (above and below atmosphere)
Control Mode	Type of automated pressure control (static or dynamic).
Control Parameters	Parameters affecting pressure control and the <i>Ready/Not Ready</i> determination (target, hold limit, stability limit).
Custom Control	Automated pressure control in which the control parameters are not the default control parameters.
Deviation	The deviation of the current pressure from the target pressure control value. Indicated in Main Run Screen when in dynamic control mode.
DUT	Device Under Test. The device or devices pneumatically connected to the PPC4E TEST port that the PPC4E is being used to test or calibrate. (see also UUT)
Dynamic Control	Control mode in which the pressure is constantly adjusted to remain as close as possible to the target value.
FS	Abbreviation of “full scale”. The full scale value is the maximum pressure or the span of a measurement range. Limits and specifications are often expressed as % FS.
Gauge Mode	Measurement mode in which the PPC4E indicates gauge pressure (difference from atmospheric pressure), but only in the positive direction (above atmosphere).
Head	A difference in height between the PPC4E test reference level and the DUT.
Hold Limit	An automated pressure control parameter. Maximum acceptable difference between the current pressure and the target pressure value.
IH or Hi	Internal Hi, an identifier for the reference pressure transducer internal to PPC4E, or the higher of two reference pressure transducers internal to PPC4EX.
IL or Lo	Internal Lo, an identifier for the lower of two reference pressure transducers internal to PPC4EX.
Measurement Mode	Whether pressure is being measured relative to absolute zero or vacuum (absolute mode) or relative to atmospheric pressure (gauge mode and negative gauge modes).
Negative gauge, compound gauge	Measurement mode in which the PPC4E indicates gauge pressure (difference from atmospheric pressure), in both positive and negative directions (above and below atmosphere).
P_{offset}	The difference between the Hi RPT reading and the Lo RPT at the last Vent.
PA	Pressure adder, used to offset a reference pressure transducer or internal barometer to calibrate it.
PM	Pressure multiplier, used to adjust span of a reference pressure transducer or internal barometer to calibrate it.
Rate	The rate of change of the current measured pressure. Indicated in the Main Run Screen when control is suspended.
Ready/Not Ready	Indication used to indicate when PPC4E pressure control meets specific criteria for distance from target pressure and stability. <i>Ready/Not Ready</i> is used to determine when test readings should be taken.
Reference Pressure Transducer (RPT)	The transducer(s) used by PPC4E for low uncertainty pressure measurement. “PPC4E” models utilize a single reference pressure transducer, and “PPC4EX” models utilize two reference pressure transducers for low uncertainty measurements over an extended range.

Span	The difference between FS and the lowest point in a range. For example, the span of a 100 kPa FS range in negative gauge mode is nominally 200 kPa (from - 100 kPa to 100 kPa).
SPLT	Self Purging Liquid Trap. An optional device to automatically protect PPC4E from liquid and particulate contamination returned from a DUT.
Stability Limit	A limit expressed in units of pressure per second (e.g., kPa/second). The stability limit is used as the <i>Ready/Not Ready</i> criterion. <i>Ready</i> if rate of change is less than stability limit. <i>Not Ready</i> if rate of change is greater than stability limit.
Static Control	Control mode in which the pressure is set near the target value and then shut OFF and allowed to evolve freely.
Target	The value to which automated pressure control sets and maintains the pressure.
UL	Same as Upper Limit.
Upper Limit	A range specific maximum value of pressure not be exceeded and at which PPC4E will abort pressure setting and beep. In negative gauge measurement mode there is also a lower limit.
UUT	Unit Under Test. The unit or units pneumatically connected to the PPC4E TEST port that the PPC4E is being used to test or calibrate.
User Level	Levels of security that can be set to protect certain PPC4E functions from being accessed.