

**FLUKE®**

# **51 & 52 Series II**

Thermometer

Users Manual

#### **Limited Warranty & Limitation of Liability**

This Fluke product will be free from defects in material and workmanship for 3 years from the date of purchase. This warranty does not cover fuses, disposable batteries or damage from accident, neglect, misuse or abnormal conditions of operation or handling. Resellers are not authorized to extend any other warranty on Fluke's behalf. To obtain service during the warranty period, send your defective tester to the nearest Fluke Authorized Service Center with a description of the problem.

THIS WARRANTY IS YOUR ONLY REMEDY. NO OTHER WARRANTIES, SUCH AS FITNESS FOR A PARTICULAR PURPOSE, ARE EXPRESSED OR IMPLIED. FLUKE IS NOT LIABLE FOR ANY SPECIAL, INDIRECT, INCIDENTAL OR CONSEQUENTIAL DAMAGES OR LOSSES, ARISING FROM ANY CAUSE OR THEORY. Since some states or countries do not allow the exclusion or limitation of an implied warranty or of incidental or consequential damages, this limitation of liability may not apply to you.

10/96

## Table of Contents

Title	Page
Introduction .....	1
Contacting Fluke.....	1
Getting Started .....	4
Components .....	5
Display Elements.....	6
Buttons .....	7
Using the Thermometer.....	9
Changing Setup Options .....	9
Entering or Exiting Setup.....	9
Setup Options.....	9
Changing a Setup Option .....	10
Measuring Temperatures .....	11
Connecting a Thermocouple.....	11
Displaying Temperatures.....	11
Holding the Displayed Readings.....	12
Viewing the MIN, MAX, and AVG Readings .....	12
Using the Offset to Adjust for Probe Errors .....	12

**51 & 52 Series II**  
*Users Manual*

---

Maintenance .....	1 3
Replacing the Batteries .....	13
Cleaning the Case and Holster .....	13
Calibration .....	13
Specifications .....	13
Environmental .....	13
General .....	14
80 PK-1 Thermocouple (supplied with thermometer) .....	14
Electrical .....	1 4
Replacement Parts and Accessories .....	15

## **51 & 52 Series II**

### ***Introduction***

The Fluke Model 51 and Model 52 Thermometers (“the thermometer”) are microprocessor-based, digital thermometers designed to use external J-, K-, T-, and E-type thermocouples (temperature probes) as temperature sensors.

Use the thermometer only as specified in this manual. Otherwise, the protection provided by the meter may be impaired.

Refer to safety information in Table 1 and meter symbols in Table 2.

Table 1. Safety Information

**⚠ Warning**

A Warning identifies conditions and actions that pose hazards to the user. To avoid electrical shock or personal injury, follow these guidelines:

- Before using the thermometer inspect the case. Do not use the thermometer if it appears damaged. Look for cracks or missing plastic. Pay particular attention to the insulation around the connectors.
- Disconnect the thermocouple(s) from the thermometer before opening the case.
- Replace the batteries as soon as the battery indicator (🔋) appears. The possibility of false readings can lead to personal injury.
- Do not use the thermometer if it operates abnormally. Protection may be impaired. When in doubt, have the thermometer serviced.
- Reflective objects result in lower than actual temperature measurements. These objects pose a burn hazard.
- Do not operate the thermometer around explosive gas, vapor, or dust.
- Do not connect to voltages > 30 V ac rms, 42 V pk, 60 V dc from earth ground.

Table 1. Safety Information (cont.)

**⚠ Warning (cont.)**





- **Model 52:** Measurement errors may occur if voltages on the measurement surfaces result in potentials greater than 1 V between the two thermocouples. When potential differences are anticipated between the thermocouples, use electrically insulated thermocouples.
- When servicing the thermometer, use only specified replacement parts.
- Do not use the thermometer with any part of the case or cover removed.

**Caution**

A Caution identifies conditions and actions that may damage the meter or the equipment under test.

- Use the proper thermocouples, function, and range for your thermometer.
- Do not attempt to recharge the batteries.
- To prevent explosion, do not throw batteries into a fire.
- Follow local laws or regulations when disposing of batteries.
- Match the + and – polarities of the battery with the battery case.

Table 2. International Symbols

	Refer to the manual for information about this feature.		Complies with European Union directives.
	Battery.		Complies with relevant Canadian Standards Association directives.

### Getting Started

Everything in this *Users Manual* applies both to Models 51 and 52 unless otherwise indicated.

To become familiar with the thermometer, study the following:

- Figure 1 and Table 3 describe the components.
- Figure 2 and Table 4 describe the display.
- Table 5 describes the functions of the buttons.

Then read the following sections.



**Components**

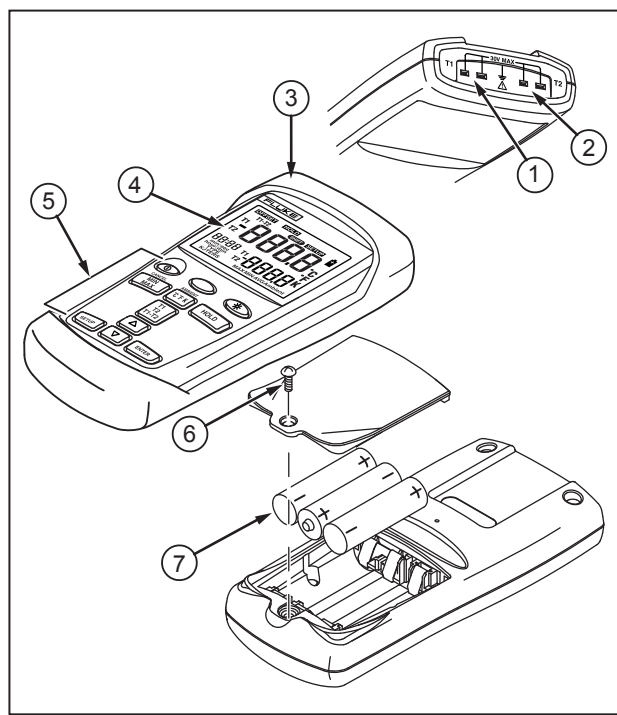

Figure 1. Components

aas01f.eps

Table 3. Components

①	Thermocouple T1 input
②	Model 52: Thermocouple T2 input
③	Holster
④	Display
⑤	Buttons
⑥	Battery door
⑦	Batteries

**Display Elements**

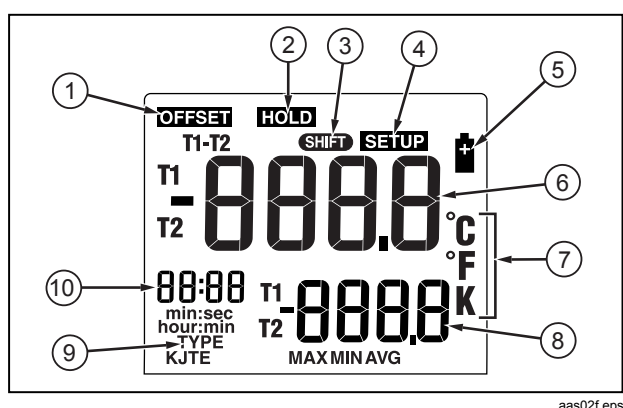

Figure 2. Display Elements

Table 4. Display Elements

①	The thermocouple measurement includes an offset. See "Changing Setup Options."
②	The displayed readings do not change.
③	A shift function is in progress.
④	Setup is in progress.
⑤	Low battery. Replace the batteries.
⑥	Primary Display. <i>Model 51:</i> T1 reading. <i>Model 52:</i> T1, T2, or T1-T2 reading.
⑦	The temperature unit.
⑧	Secondary Display: MAX, MIN, AVG, or offset. <i>Model 52:</i> T1 or T2 reading.
⑨	The thermocouple type.
⑩	Time Display: The elapsed time.

**Buttons**

**Table 5. Buttons**































	Press  to turn the thermometer on or off.
 (Shift function)	Press  ,  (CANCEL) to stop displaying the minimum, maximum, and average readings in the secondary display.
	Press  to turn the backlight on and off. The backlight turns off after 2 minutes without any button presses. If the battery is low, the backlight is disabled.
	Press  to step through the maximum, minimum, and average readings. When viewing logged readings, shows the maximum, minimum, and average of the logged readings. Press  ,  (CANCEL) to turn off this display.
	Press  to switch between Celsius (°C), Fahrenheit (°F), and Kelvin (K).
	Press  to freeze or unfreeze the displayed readings. Press  when turning on the thermometer to test the display. All display elements appear.
	<i>Model 52:</i> Press  to toggle showing the T1, T2, and T1-T2 (differential temperature measurement) in the primary or secondary display.

Table 5. Buttons (cont.)

	Press  to start or exit Setup. (See "Changing Setup Options.")
	Press  to scroll to the Setup option you want to change. Press  to increase the displayed setting.
	Press  to scroll to the Setup option you want to change. Press  to decrease the displayed setting.
	Press  to enter a Setup option. Press  again to store the displayed setting in memory.

### Using the Thermometer

1. Plug the thermocouple(s) into the input connector(s).
2. Press  to turn on the thermometer.

After 1 second the thermometer displays the first reading. If no thermocouple is plugged into the selected input or the thermocouple is "open," the display shows "- - -"

### Changing Setup Options

Use Setup to change the thermocouple type, offset, sleep mode, and line frequency settings.

The thermometer stores the settings in its memory. Setup settings reset only when the batteries are removed for more than 2 minutes.

### Entering or Exiting Setup







When the thermometer is in Setup mode, the display shows **SETUP**.

- Press  to start or exit Setup.

### Setup Options

Option	Menu Item	Settings
Thermocouple Type	<b>TYPE</b>	J, K, T, or E
Offset	<b>OFFSET</b>	T1 or T2 (Model 52)
Sleep Mode	<b>SLP</b>	<b>on</b> (sleep mode on) or <b>OFF</b> (sleep mode off)
Line Frequency	<b>Line</b>	<b>50 H</b> (50 Hz) or <b>60 H</b> (60 Hz)

### Changing a Setup Option

1. Press  or  to scroll to the setup option you want to change.
2. Press  to indicate that you want to change this setting.
3. Press  or  until the setting you want to use appears on the display.
4. Press  to store the new setting in memory.

#### Notes

Setup is disabled in MIN MAX mode.

#### Offset:

The primary display shows the temperature plus the offset and the secondary display shows the offset. Remember to reset the offset to 0.0 when it is no longer needed. The offset automatically resets to 0.0 when you change the thermocouple type. Model 52: You can store individual offsets for T1 and T2.

#### Sleep mode:

The thermometer enters sleep mode if no button press occurs for 20 minutes. Pressing any button wakes the thermometer and returns it to its previous state. Sleep mode becomes enabled each time you turn on the thermometer and is automatically disabled in MIN MAX mode.

#### Line frequency:

For optimum rejection of line noise, the thermometer must be set for the local line frequency.

## Measuring Temperatures

### Connecting a Thermocouple

To change the thermocouple type, see "Changing Setup Options." The North American ANSI Color Code is:

Type	J	K	E	T	N
Color	Black	Yellow	Purple	Blue	Orange

1. Plug a thermocouple into the input connector(s). (Make sure that the polarity is correct.)
2. Set the thermometer for the correct thermocouple type.

### Displaying Temperatures

1. Press  $\square_{\text{CFK}}$  to select the correct temperature scale.
2. Hold or attach the thermocouple(s) to the measurement location.

The temperature reading appears in the primary display.

3. *Model 52:* Press  $\square_{\begin{smallmatrix} T1 \\ T2 \\ T1-T2 \end{smallmatrix}}$  to toggle between showing the T1, T2, and T1-T2 readings in the primary or secondary display.

### Notes

The display shows " - - - " when a thermocouple is not connected.

The display shows **OL** (overload) when the temperature being measured is outside the thermocouple's valid range.

*Model 52:* If only thermocouple T2 is connected, the T2 reading appears in the primary display.

#### **Holding the Displayed Readings**

1. Press **HOLD** to freeze the readings on the display.  
The display shows **HOLD**.
2. *Model 52:* Press **T1 T2** to toggle showing the T1, T2, or T1-T2 readings in the primary or secondary display.
3. Press **HOLD** again to turn off the HOLD function.

#### **Viewing the MIN, MAX, and AVG Readings**

1. Press **MIN MAX** to step through the maximum (MAX), minimum (MIN), or the average (AVG) readings.  
The elapsed time since entering MIN MAX mode, or the time at which the minimum or maximum occurred, appears on the display.
2. Press **○**, **MIN MAX** (CANCEL) to exit MIN MAX mode.

#### **Using the Offset to Adjust for Probe Errors**

Use the offset option in Setup to adjust the thermometer's readings to compensate for the errors of a specific thermocouple.

The allowable adjustment range is  $\pm 5.0$  °C or K, and  $\pm 9.0$  °F.

1. Plug the thermocouple into the input connector.
2. Place the thermocouple in a known, stable temperature environment (such as an ice bath or a dry well calibrator).
3. Allow the readings to stabilize.
4. In Setup change the offset until the primary display reading matches the calibration temperature. (See "Changing Setup Options.")



### **Maintenance**

#### **Replacing the Batteries**

Refer to the safety information in Table 1 before replacing the batteries.

1. Turn off the thermometer if necessary.
2. Loosen the screw and remove the battery door.
3. Replace the three AA batteries.
4. Replace the battery door and tighten the screw.

#### **Cleaning the Case and Holster**

Use soap and water or a mild commercial cleaner.

Wipe with a damp sponge or soft rag.

### **Calibration**

To ensure that the thermometer performs to its accuracy specifications, Fluke recommends that you calibrate the thermometer annually, starting one year after purchase.

To calibrate the thermometer, contact Fluke for the Service Center nearest you or follow the calibration procedure in the service manual listed in "Replacement Parts and Accessories."

### **Specifications**

#### **Environmental**

<b>Operating Temperature</b>	-10 °C to 50 °C (14 °F to 122 °F)
<b>Storage Temperature</b>	-40 °C to +60 °C (-40 °F to +140 °F)
<b>Humidity</b>	Non condensing <10 °C (<50 °F) 95 % RH: 10 °C to 30 °C (50 °F to 86 °F) 75 % RH: 30 °C to 40 °C (86 °F to 104 °F) 45 % RH: 40 °C to 50 °C (104 °F to 122 °F)

**51 & 52 Series II**  
Users Manual

**General**

<b>Weight</b>	280 g (10 oz)
<b>Dimensions (without holster)</b>	2.8 cm × 7.8 cm × 16.2 cm (1.1 in × 3 in × 6.4 in)
<b>Battery</b>	3 AA batteries
<b>Certification</b>	CE, 
<b>Safety</b>	CAN/CSA C22.2 No. 61010-1-04, ANSI/UL 61010-1:2004, EN/IEC 61010-1:2001
<b>EMC</b>	EN/IEC 61326-1:2006
<b>CAT I</b>	OVERVOLTAGE (Installation) CATEGORY I, Pollution Degree 2 per IEC1010-1*
* Refers to the level of Impulse Withstand Voltage protection provided. Category 1 products should not be attached to mains circuits.	

**80 PK-1 Thermocouple (supplied with thermometer)**

<b>Type</b>	Type K, Chromel Alumel, bead style
<b>Temperature Range</b>	-40 °C to +260 °C (-40 °F to +500 °F)
<b>Accuracy</b>	± 1.1 °C (± 2.0 °F)

**Electrical**

<b>Measurement Range</b>	J-type: -210 °C to +1200 °C (-346 °F to + 2192 °F) K-type: -200 °C to +1372 °C (-328 °F to +2501 °F) T-type: -250 °C to +400 °C (-418 °F to +752 °F) E-type: -150 °C to +1000 °C (-238 °F to +1832 °F)
<b>Display Resolution</b>	0.1 °C / °F / K <1000° 1.0 °C / °F / K ≥1000°

**51 & 52 Series II**  
Replacement Parts and Accessories

**Electrical (cont.)**

<b>Measurement Accuracy, T1, T2, or T1-T2 (Model 52)</b>	J-, K-, T-, and E-type: $\pm[0.05\%$ of reading + 0.3 °C (0.5 °F)] [below -100 °C (-148 °F): add 0.15 % of reading for J-, K-, E-, and N-type; and 0.45 % of reading for T-type]
<b>Temperature Coefficient</b>	0.01 % of reading + 0.03 °C per °C (0.05 °F per °F) outside the specified +18 °C to 28 °C (+64 °F to +82 °F) range [below -100 °C (-148 °F): add 0.04 % of reading for J-, K-, E-, and N-type; and 0.08 % of reading for T-type]
<b>Electromagnetic Compatibility</b>	Susceptibility: $\pm 2$ °C ( $\pm 3.6$ °F) for 80 MHz to 200 MHz in 1.5 V/m field, for 200 MHz to 1000 MHz in 3 V/m field. Emmissions: Commercial Limits per EN50081-1
<b>Maximum Differential Common Mode Voltage</b>	1 V (Maximum voltage difference between T1 and T2)
<b>Temperature Scale</b>	ITS-90

<b>Applicable Standards</b>	NIST-175
Accuracy is specified for ambient temperatures between 18 °C (64 °F) and 28 °C (82 °F) for a period of 1 year. The above specifications do not include thermocouple error.	

**Replacement Parts and Accessories**

<b>Accessory</b>	<b>Part Number</b>
Holster and Flex Stand™ Assembly	1272438
AA NEDA 15A IEC LR6 batteries	376756
80PK-1 K-Type Bead Thermocouple	773135
CD-ROM	1276106
Service Manual	1276123