

**FLUKE®**

# 417D/424D

Laser Distance Meters

Users Manual



September 2019

© 2012-2019 Fluke Corporation. All rights reserved.

Specifications are subject to change without notice.

All product names are trademarks of their respective companies.

## LIMITED WARRANTY AND LIMITATION OF LIABILITY

Each Fluke product is warranted to be free from defects in material and workmanship under normal use and service. The warranty period is three years and begins on the date of shipment. Parts, product repairs, and services are warranted for 90 days. This warranty extends only to the original buyer or end-user customer of a Fluke authorized reseller, and does not apply to fuses, disposable batteries, or to any product which, in Fluke's opinion, has been misused, altered, neglected, contaminated, or damaged by accident or abnormal conditions of operation or handling. Fluke warrants that software will operate substantially in accordance with its functional specifications for 90 days and that it has been properly recorded on non-defective media. Fluke does not warrant that software will be error free or operate without interruption.

Fluke authorized resellers shall extend this warranty on new and unused products to end-user customers only but have no authority to extend a greater or different warranty on behalf of Fluke. Warranty support is available only if product is purchased through a Fluke authorized sales outlet or Buyer has paid the applicable international price. Fluke reserves the right to invoice Buyer for importation costs of repair/replacement parts when product purchased in one country is submitted for repair in another country.

Fluke's warranty obligation is limited, at Fluke's option, to refund of the purchase price, free of charge repair, or replacement of a defective product which is returned to a Fluke authorized service center within the warranty period.

To obtain warranty service, contact your nearest Fluke authorized service center to obtain return authorization information, then send the product to that service center, with a description of the difficulty, postage and insurance prepaid (FOB Destination). Fluke assumes no risk for damage in transit. Following warranty repair, the product will be returned to Buyer, transportation prepaid (FOB Destination). If Fluke determines that failure was caused by neglect, misuse, contamination, alteration, accident, or abnormal condition of operation or handling, including overvoltage failures caused by use outside the product's specified rating, or normal wear and tear of mechanical components, Fluke will provide an estimate of repair costs and obtain authorization before commencing the work. Following repair, the product will be returned to the Buyer transportation prepaid and the Buyer will be billed for the repair and return transportation charges (FOB Shipping Point).

THIS WARRANTY IS BUYER'S SOLE AND EXCLUSIVE REMEDY AND IS IN LIEU OF ALL OTHER WARRANTIES, EXPRESS OR IMPLIED, INCLUDING BUT NOT LIMITED TO ANY IMPLIED WARRANTY OF MERCHANTABILITY OR FITNESS FOR A PARTICULAR PURPOSE. FLUKE SHALL NOT BE LIABLE FOR ANY SPECIAL, INDIRECT, INCIDENTAL OR CONSEQUENTIAL DAMAGES OR LOSSES, INCLUDING LOSS OF DATA, ARISING FROM ANY CAUSE OR THEORY.

Since some countries or states do not allow limitation of the term of an implied warranty, or exclusion or limitation of incidental or consequential damages, the limitations and exclusions of this warranty may not apply to every buyer. If any provision of this Warranty is held invalid or unenforceable by a court or other decision-maker of competent jurisdiction, such holding will not affect the validity or enforceability of any other provision.

# Table of Contents

Title	Page
Introduction .....	1
How to Contact Fluke .....	1
Safety Information.....	1
Product Familiarization .....	2
Features.....	2
Before You Start .....	2
Multifunction Endpiece .....	3
Display .....	4
Keypad .....	6
Measurements with a Tripod.....	8
Reference Point .....	8
Functions .....	9
Units of Measurement.....	9
Backlight .....	9
Keypad Lock .....	9
Memory .....	9
Addition/Subtraction.....	9
Compass.....	10
Compass Calibration.....	10
Magnetic Declination.....	10
Timer.....	12
Beeper .....	12
Measurements.....	12
Single Distance Measurement .....	12
Continuous Measurement.....	12
Minimum/Maximum Tracking.....	13
Area .....	13

417D .....	13
424D .....	13
Volume .....	14
Tilt.....	14
Smart Horizontal Mode.....	14
Height Tracking .....	15
Leveling .....	15
Tilt Sensor Calibration .....	16
Stake Out Measurement .....	16
Corner Angle Measurement .....	17
Indirect Measurement.....	18
Maintenance.....	20
Clean the Product.....	20
Batteries .....	20
Information or Error codes .....	21
Specifications .....	22

## ***Introduction***

The Fluke 417D and 424D Laser Distance Meters (Meter or Product) are professional-grade laser distance meters. Use these Meters to quickly and accurately get the distance to a target, the area, and the volume measurements.

This Meter is better than an ultrasonic device because it uses laser light waves and measures their reflection. The Meter includes:

- Most advanced technology for distance measurements
- More accurate measurement
- Longer measurement distance – *model dependent*

## Product Familiarization

The manual explains features for multiple models. Because models have different features, not all of the information in the manual may apply to your Product.

### Features

Table 1 lists the features of the Product.

**Table 1. Features**

Feature	417D	424D
Handstrap	●	●
Multifunction endpiece		●
Display lines	2	4
Backlight	●	●
Keypad illumination		●
Keypad lock		●
Memory		●
Compass		●
Distance Measurement	●	●
Continuous measurement		
without min/max tracking	●	
with min/max tracking		●
Area	●	●

**Table 1. Features (cont.)**

Feature	417D	424D
Volume		●
Tilt (Smart horizontal mode, height tracking, leveling)		●
Stake Out		●
Triangular area		●
Pythagoras calculations		●
Room corner angle		●
Add/Subtract		●
Tripod measurement		●
Timer		●
Beeper		●

### Before You Start

This section has basic information about the Meter.

### Multifunction Endpiece

Use the multifunctional endpiece to adapt to multiple measurement situations. A built-in sensor automatically senses the orientation of the endpiece and adjusts the zero point. See Figure 1.

- For measurements from an edge, fold out the endpiece (90 °) until it locks into place. See Figure 2.
- For measurements from a corner, fold out the endpiece (90 °) until it locks into place. Push the endpiece lightly to the right side to fold it out fully. See Figures 1 and 3.

Figure 1. Multifunction Endpiece

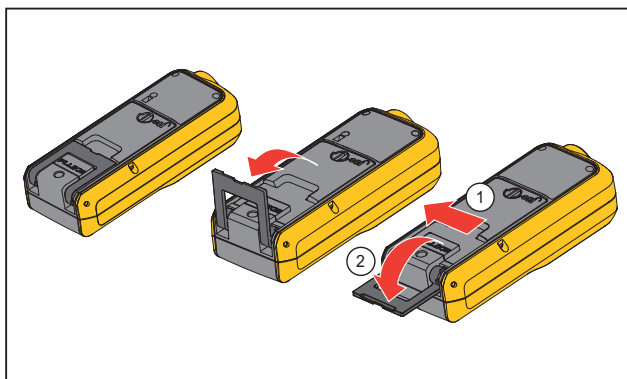

Figure 2. Edge Measurements

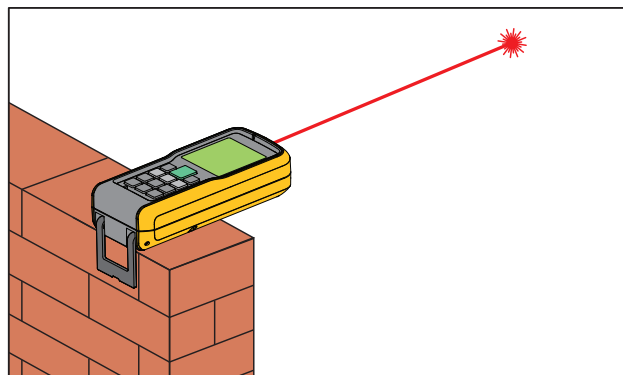
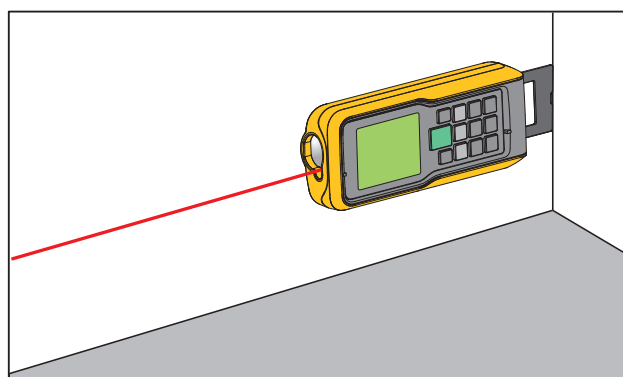

Figure 3. Corner Measurements



**Display**

Table 2 shows the readout location on the display for each function of the 417D.

Table 3 shows the readout location on the display for each function of the 424D.

**Table 2. Display 417D**

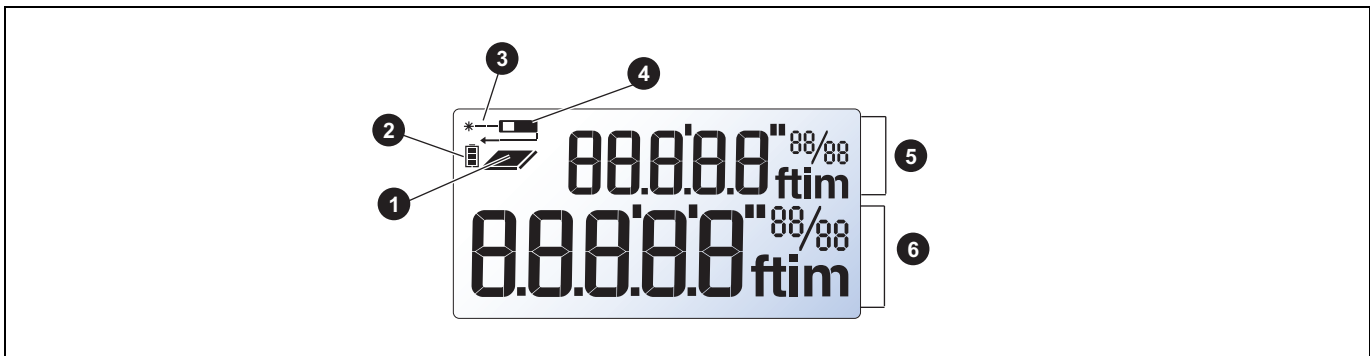

Item	Description
1	Area
2	Battery Status
3	Laser Indication
4	Measurement Reference
5	Previous Measurement
6	Measurement (Error code will also display here.)



Table 3. Display 424D

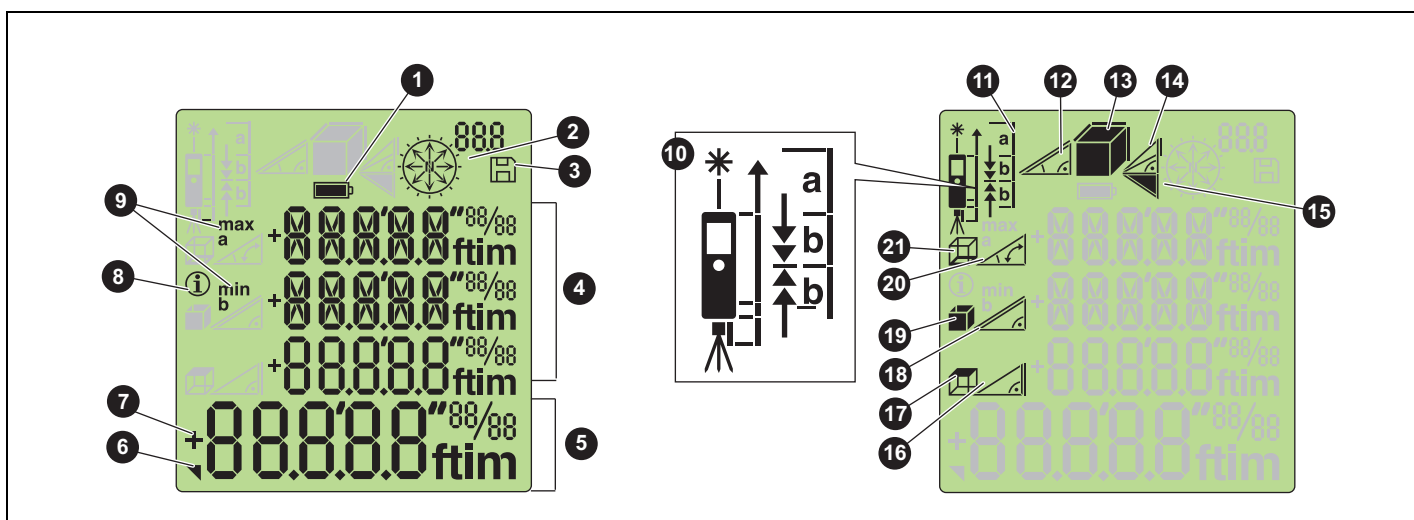

Item	Description	Item	Description	Item	Description
1	Battery Status	8	Information	15	Triangle Area
2	Compass / Timer readout	9	Min/Max Measurement	16	Indirect Height
3	Memory	10	Measurement Reference	17	Ceiling Area
4	Additional Measurements / Status	11	Stake out	18	Slope Distance
5	Measurement	12	Leveling	19	Wall Area
6	2nd Result Available	13	Area/Volume	20	Tilt Angle
7	Addition Subtraction	14	Pythagoras	21	Circumference



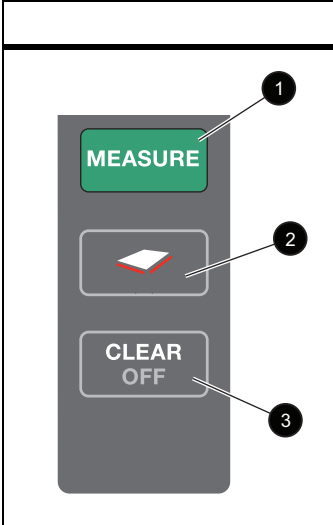

**Keypad**

Table 4 shows the buttons on the keypad on the 417D. Table 6 shows the keypad of the 424D.

**Table 4. Keypad 417D**

	Item	Description
	1	On/Measure
	2	Area/Units
	3	Clear/Off

**Table 5. 417D Button Operation**

Button	Pushes	Function
	1x	Turn on the Product and laser. (The battery symbol shows by default.)
	2x	Take a measurement.
	2 seconds	Continuous measurement mode. To cancel, push  again.
	1x	Start an area measurement.
	2 seconds	Select units of measure (see Table 8).
	1x	Clear last measurement.
	2 seconds	Turn off the Product.

**Table 6. Keypad 424D**

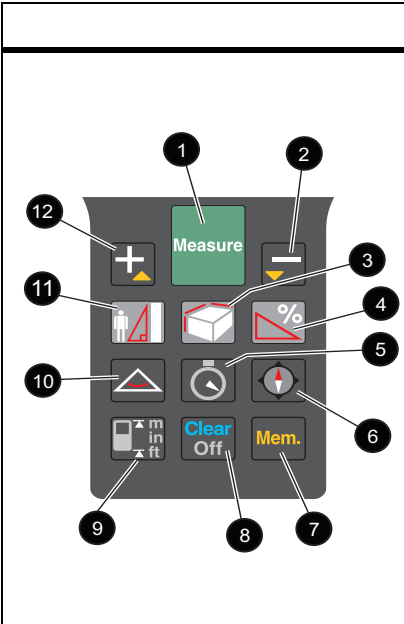
	Item	Description
	1	On/Measure
	2	Minus
	3	Area/Volume
	4	Tilt
	5	Timer
	6	Compass
	7	Memory
	8	Clear/Off
	9	Reference/Units
	10	Triangle
	11	Indirect Measurement
	12	Plus

**Table 7. 424D Button Operation**

Button	Pushes	Function
	1x	Turn on the laser.
	2x	Take a measurement.
	2 seconds	Turn on tracking (min/max measurement).
	2 seconds (from off)	Turn on Continuous Laser.

**Table 7. 424D Button Operation (cont.)**











Button	Pushes	Function
	1x	Start area measurement.
	2x	Start volume measurement.
	2 seconds	View 2 <sup>nd</sup> Results.
	1x	Turn on Smart Horizontal Mode.
	2x	Turn on Height Tracking.
	3x	Turn on Leveling.
	1x	Arrow points in north direction.
	2 seconds	Arrow points in direction of Laser beam and display shows the direction in degrees and an alpha symbol.
	1x	Clear last value.
	2x	Clear all
	2 seconds	Turn off Meter.
	1x	Turn on Room Corner Angle (Triangular Area)
	2 seconds	View 2 <sup>nd</sup> Results.
	1x	Pythagoras 1
	2x	Pythagoras 2
	3x	Pythagoras 3
	4x	Stake Out (2 values)

Table 7. 424D Button Operation (cont.)

Button	Pushes	Function
	1x	Measure from front 
	2x	Measure from tripod screw 
	3x	Measure from end 
	2 seconds	Select units of measure (See Table 8.)

### Measurements with a Tripod

Measurements with the 424D that use a tripod must have the tripod reference set. When set,  shows on the display.

### Reference Point

The display shows the reference point for a measurement. The default reference point is from the end of the Meter. If the beeper is on, the Meter beeps as you change the reference point. See Figure 4 for more information.

The Meter automatically adjusts the reference point when you use the endpiece and  shows on the display.

#### Note

*The tripod mode overrides other reference points. The Meter stays in the tripod mode until you change to a different reference point.*

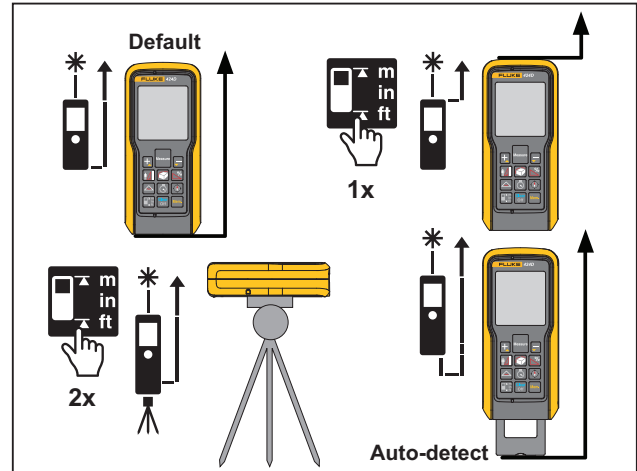

Figure 4. Change Reference Point



## Functions

This section shows how to use non-measurement functions.

### Units of Measurement



Push and hold  (417D) or  (424D) for 2 seconds to step through the units for distance measurements. See Table 8.

**Table 8. Units of Measure**

417D	424D
0.000 m	0.000 m
0.0000 m	0.0000 m
0.00 ft	0.00 m
0' 00" 1/32	0.00 ft
0 in 1/32*	0'00 1/32*
* Default	0.000 in
	0 in 1/32

\* Default

### Backlight

Push   at the same time for 2 seconds to turn on and turn off the backlight. The display shows the status as ILLU ON or ILLU OFF.

### Keypad Lock

To lock the keypad, push   at the same time.





To unlock:

1. Push .
2. Push  within 2 seconds to unlock the keypad.

### Memory

You can recall a previous measurement from memory, for example, the height of a room. The Meter stores a maximum of 20 displays.

To recall:

1. Push  1x.
2. Push  and  to move through the stored displays.  and the memory ID show on the display.
3. Push  for 2 seconds to use the value shown in the Summary line for further calculations.

To delete:



- Push  and  at the same time.

The Meter deletes all the stored values in memory.

### Addition/Subtraction

The Meter adds and subtracts a value to a single distance, area, and volume measurements.

To add or subtract:

1. Push  to add the next measurement to the previous measurement, or push  to subtract the next measurement from the previous measurement.
2. Do these steps again for each measurement.  
The total measurement result is always shown in the summary line with the value before in the second line.
3. Push  to cancel the last step.

## Compass

The compass feature lets you know the view or direction as you make measurements. This is useful indoors to set the building plans in the correct direction. It is also useful to know the correct direction when you calculate the efficiency for a solar panel. See Table 7.

Tips:

- Make sure that the endpiece is folded in.
- When you use the compass feature, the Meter shows the calibration message. See [Compass Calibration](#) for more information.
- Compass arrows blink on the display if the Meter is tilted  $>20^\circ$  end to end or  $>10^\circ$  side to side.
- When you turn on the compass, the Meter shows the calibration message. See [Manual Calibration](#) for more information.

### ⚠ Caution

To prevent incorrect direction readouts, do not use near magnets and magnetic devices.

## Compass Calibration

### Automatic Calibration

The compass sensor continuously collects and saves new calibration values in 60-second intervals.

### Manual Calibration

When you turn on the compass, the Meter shows the calibration message:

1. For no, push **[-]**. The compass uses old data that can be inaccurate.
2. For yes, push **[+]**.

To continue with the calibration:

- a. Rotate the Meter  $180^\circ$  around the Z-axis. See Figure 5.
- b. Rotate the Meter  $180^\circ$  around the X-axis.
- c. Rotate the Meter  $180^\circ$  around the Y-axis.

The Meter counts from 1 to 12 during calibration. COMPA OK shows on the display when the calibration is complete.

Figure 5. Manual Calibration

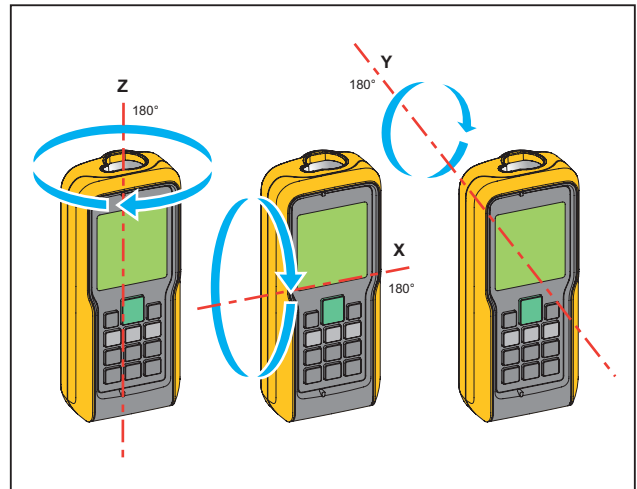

## Magnetic Declination

The difference between the north geographic pole and the north magnetic pole is known as magnetic declination, or more plainly, declination. The angle of declination is different at different locations on the earth. The geographic and magnetic poles are aligned so declination is minimal. From some locations, the angle between the two poles can be fairly large.

Table 9 is a list of the current angles of declination by location.

For other declination values, contact your local Geomagnetic Institute.

To set the Meter with the correct compensation for your location:

1. Push   at the same time.

The display shows dECLI and the current setting. The default value is 0 °.

2. Push  and  to change the value.

3. Push  to accept the new value.





**Table 9. Estimated Values of Magnetic Field**

Country	City	Declination in Degrees (+E   -W)	Country	City	Declination in Degrees (+E   -W)	Country	City	Declination in Degrees (+E   -W)
Argentina	Buenos Aires	-7	Greenland	Godthab	-29	Spain	Madrid	-1
Australia	Darwin	3	Iceland	Reykjavik	-15	Switzerland	Zurich	1
Australia	Perth	-1	Italy	Rome	2	Thailand	Bangkok	0
Australia	Sidney	12	India	Mumbai	0	Ukraine	Donetsk	7
Austria	Vienna	3	Japan	Tokyo	-7	UAE	Dubai	1
Brazil	Brasilia	-20	Kenya	Nairobi	0	United Kingdom	London	-1
Brazil	Rio de Janeiro	-22	Norway	Oslo	2	USA	Anchorage	18
Canada, BC	Vancouver	17	Panama	Panama	-3	USA	Dallas	3
Chili	Santiago de Chile	2	Russia	Irkutsk	-3	USA	Denver	8
China	Beijing	-6	Russia	Moscow	10	USA	Honolulu	9
Egypt	Cairo	3	Russia	Omsk	11	USA	Los Angeles	12
France	Paris	0	Senegal	Dakar	-8	USA	Miami	-6
Germany	Berlin	2	Singapore	Singapore	0	USA	New York	-13
Greece	Athens	3	South Africa	Cape Town	-24	Venezuela	Caracas	-11

### Timer

Fluke recommends that you use a time-delay for the most accurate measurements at long distances. This prevents Meter movement when you push .

To turn on the timer:



1. Push  1x to turn on the 5-second timer. This is the default time interval to release the laser for a measurement.
2. Push  or  to adjust the timer up to 60 seconds.
3. Push  to begin the timer.

The seconds until measurement (for example, 59, 58, 57...) show as a countdown. The last 5 seconds count down with a beep. After the last beep, the Meter makes the measurement and the value shows on the display.

#### Note

*The timer is useful for all measurements.*

### Beeper



Push   at the same time for 2 seconds to turn on and turn off the beeper. The display shows the status as BEEP ON or BEEP OFF.

### Measurements

The Meter measures the distance to a target, the area bounded by two distances, or the volume in three measurements.

#### Single Distance Measurement

To measure distance:

1. Push  to turn on the laser.
2. Push  again to make the distance measurement.

The measurement shows on the display.

#### Note

*Measurement errors can occur if you point the laser at colorless liquids, glass, polystyrene, semi-permeable surfaces, and high-gloss surfaces. The measurement time increases when you point the laser at dark surfaces.*



A target plate is useful for long distance measurements if the target reflectivity and illumination is a problem.

#### Continuous Measurement

Use continuous measurement to make a series of quick measurements. For example, to mark stud positions along a wall plate.

To start continuous measurement:

1. While the meter is on, push  for 2 seconds.
2. Move the laser to each position and view each measurement.

The Meter continuously shows measurements until you push  or  or the Meter times out.





### Minimum/Maximum Tracking

The tracking function measures the room diagonal (maximum value) and the horizontal distance (minimum value) from a stable measurement point. It also can find the distance between objects. See Figure 6.

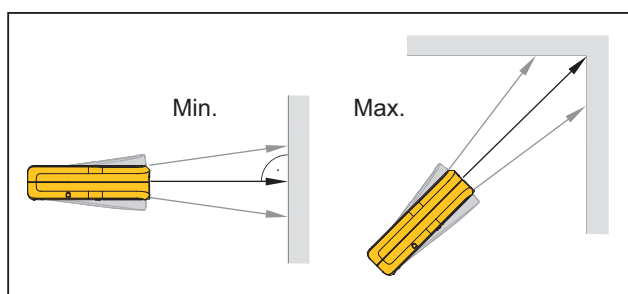
Figure 6. Minimum/Maximum Tracking



To measure:

1. Push and hold  for 2 seconds.  
→\* shows on the display to confirm that the Meter is in tracking mode.
2. Move the laser side to side, up and down on the target area (for example, into the corner of a room).
3. Push  to stop tracking mode.

The last measured value shows in the summary line.





#### Note

The values for maximum and minimum distances show in the display. The last measured value shows in the summary line.

### Area

#### 417D





To measure area:

1. Push  1x.  
The  symbol appears in the display.
2. Push  to make the first measurement (for example, length).
3. Push  again to make the second measurement (for example, width).

The result shows in the summary line.





#### 424D

To measure area:

1. Push  1x.  
The  symbol shows in the display.
2. Push  to make the first measurement (for example, length).
3. Push  again to make the second measurement (for example, width).  
The result shows in the summary line.
4. Push  and hold for 2 seconds to get the 2<sup>nd</sup> result as a circumference.



## Volume

To measure volume:

1. Push  2x.  
The  symbol appears in the display.
2. Push  to make the first measurement (for example, length).
3. Push  again to make the second measurement (for example, height).
4. Push  again to make the third length measurement (for example, depth).

The result shows in the summary line.

5. Push  x 2 seconds to show additional room information such as ceiling/floor area, surface area of the walls, circumference.

-  Ceiling/floor area
-  Wall area
-  Circumference



## Tilt

### Note



*The inclinometer senses tilts at 360 °. For tilt measurements, hold the Meter without a transverse tilt ( $\pm 10$  °).*



### Smart Horizontal Mode

Use the Smart Horizontal mode (indirect horizontal distance) function to find a horizontal distance when the line-of-sight is blocked by an object or obstacle. See Figure 7 for more information.

The tilt is continuously shown as ° or %. To change the units, push and hold   at the same time for 2 seconds. The default unit is °.

To measure:

1. Push  1x.  
 shows in the display.
2. Point laser at target.
3. Push .

The display shows all results as  $\alpha$  (angle ) , x (diagonal distance ) , and y (vertical distance ) . The z (horizontal distance) shows in the summary line.

4. Push  to turn off Smart Horizontal Mode.

Figure 7. Smart Horizontal Mode

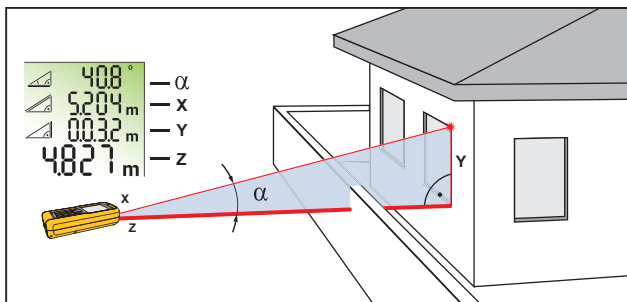

### Height Tracking

Height tracking shows continuously on the display as the Meter turns on a tripod. The tilt is continuously shown in the selected unit of measure as  $^{\circ}$  or %.

To measure:

1. Push 2x.  
 $\sphericalangle$  shows in the display.
2. Point the laser at lower target.
3. Push .
 $\sphericalangle$  shows in the display with the distance and angle to the lower target.
4. Move the laser upwards to the top target.  
 Height Tracking starts automatically. The display shows the angle to the actual target and the vertical distance from the lower target.
5. Push at the top target.

Height Tracking stops and the display shows the vertical distance between the two measured targets. See Figure 8 for more information.

### Note

The minimum/maximum tracking is very helpful for  $90^{\circ}$  angle measurements. See [Minimum/Maximum Tracking](#).

Figure 8. Height Tracking

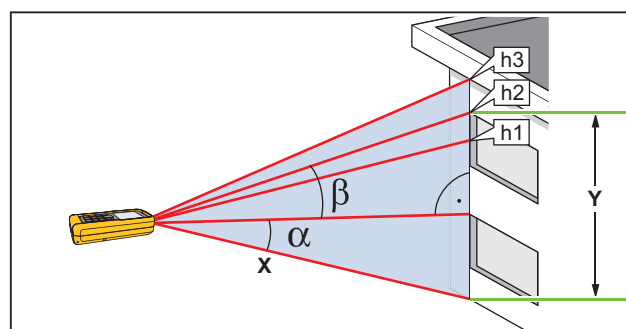

### Leveling

The Leveling function continuously shows the angle of the Meter. From an angle of  $\pm 5^{\circ}$ , the Meter starts to beep. As it gets near  $1^{\circ}$ , the Meter beeps faster. At  $\pm 0.3^{\circ}$ , the Meter beeps constantly.

To level:

1. Push 3x.  
 $\sphericalangle$  shows in the display.
2. Put the Meter on object to do a test for level.  
 The angle continuously shows on the display as the object moves.

### Tilt Sensor Calibration

To calibrate the tilt sensor:

1. Push **Clear** **On** **%** at the same time for 2 seconds.

The display shows **CAL** message and the instructions for the first measurement. See Figure 9.

Figure 9. Tilt Sensor Calibration

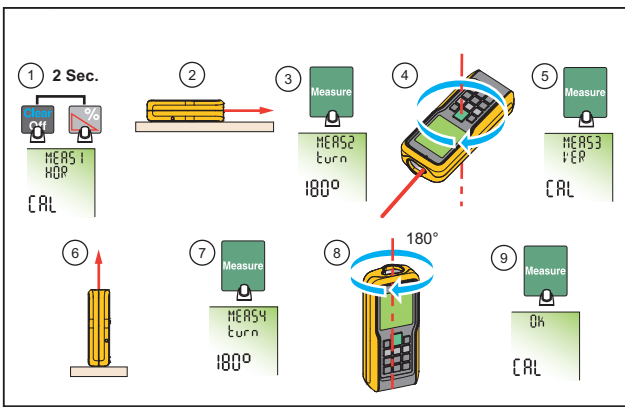

2. Put the Meter on a flat horizontal surface.
3. Push **Measure**.  
The display shows the instructions for the subsequent measurement.
4. Turn the Meter horizontally 180 ° on the same flat horizontal surface.
5. Push **Measure**.  
The display shows the instructions for the subsequent measurement.
6. Put the Meter upright on a flat horizontal surface.
7. Push **Measure**.

The display shows the instructions for the subsequent measurement.

8. Turn the upright Meter 180 ° on the same flat surface.
9. Push **Measure**.

The display shows the calibration results as **OK CAL**.

### Stake Out Measurement

A specific distance can be set in the Meter and used to mark off defined measured lengths. An example of this application is in the construction of wooden frames. See Figure 10 for more information.

#### Note

For best results, use the end reference point for a stake out measurement. See [Reference Point](#).

Figure 10. Stake Out Measurement

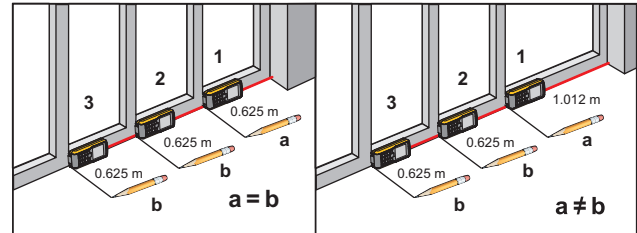

You can enter two different distances (a and b) into the Meter and use them to mark off measured lengths, for example, in the construction of wooden frames.

To find stake out distances with 2 values:

1. Push **[M]** 4x.  
 $\begin{matrix} \uparrow \\ \downarrow \end{matrix}$  shows in the display.
2. Push **[+]** and **[-]** to increase or decrease the values that show on the display.  
 The value (a), and the intermediate line that corresponds, blink on the display.
3. Push **[+]** and **[-]** to adjust the (a) value.

*Note*

Hold the buttons down to increase the rate of change for the values.

4. Push **[Measure]** to accept the (a) value.
5. Push **[+]** and **[-]** to adjust the (b) value.
6. Push **[Measure]** to accept the (b) value.  
 The display shows the stake out distance in the summary line between the stake out point (a and then b) and the Meter (rear reference).
7. Move the Meter slowly along the stake out line the displayed distance decreases.

The arrows in the display  $\begin{matrix} \uparrow \\ \downarrow \end{matrix}$  indicate in which direction the Meter needs to be moved in order to achieve the defined distance (either a or b).

*Note*

If the beeper feature is on, the Meter starts to beep at a distance of 0.1 m (4 in) from the next stake out point. As the Meter moves near to the stake out point, the beep changes and the arrows do not show on the display.

8. Push **[Clear OFF]** to stop the stake out function.

### Corner Angle Measurement

The Meter calculates the angles in a triangle with measurements from the three sides. As an example, use this function with a right-angle room corner. See Figure 11 for more information.

To make corner angle measurements:

1. Push **[Angle]** 1x.  
 $\sphericalangle$  (room corner) shows in the display.

Figure 11. Corner Angle Measurement

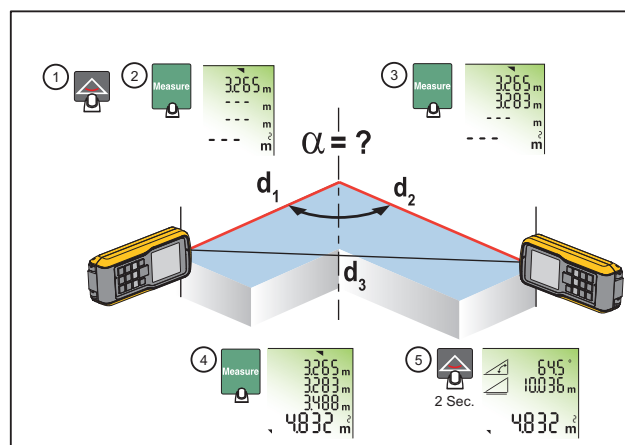

2. Put marks for the reference points to the right and left (d1/d2) of the angle for measurement.
3. Push **[Measure]** to make a measurement of the first side of the triangle (d1 or d2).
4. Push **[Measure]** to make a measurement of the second side of the triangle (d1 or d2).
5. Push **[Measure]** to make a measurement of the third side of the triangle (d3).

The result shows in the summary line as the room triangle area.

6. Push  for 2 seconds to get the second results as the angle between d1 and d2, the triangle circumference, and the area.

### Indirect Measurement

The Meter can calculate distances with Pythagoras' theorem. With this function, you can find a distance with two auxiliary measurements, such as building height or width measurements. It is helpful to use a tripod for a height measurement that uses two or three measurements.

#### Note

*Make sure that you use the correct sequence of measurement:*

- All target points must be in a horizontal or vertical plane.
- For the best results, turn the Meter about a set point. An example of this is with the endpiece fully open and the Meter on a wall.
- Make sure that the first measurement and the measurement distance are at  $90^\circ$  angles.
- The minimum/maximum tracking is very helpful for  $90^\circ$  angle measurements. See [Minimum/Maximum Tracking](#).

To find a distance with two measurements (Pythagoras 1):







1. Push  1x.  shows on the display.
2. Point the laser at the top point (1). See Figure 12.

Figure 12. Pythagoras 1



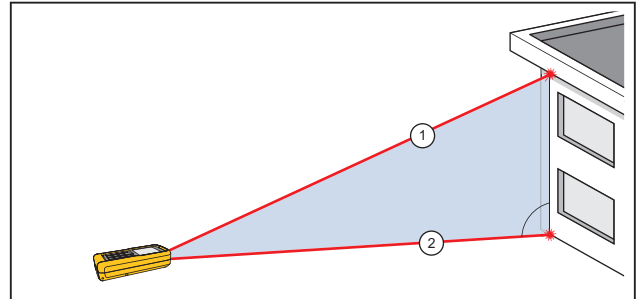



3. Push .
4. Point the laser at the second target (2).  
Make sure that the Meter is perpendicular to the wall.
5. Push  for the second distance measurement.  
The Meter shows the height in the summary line. The distance of the second measurement shows in the secondary line.

To find a total distance with three measurements (Pythagoras 2):

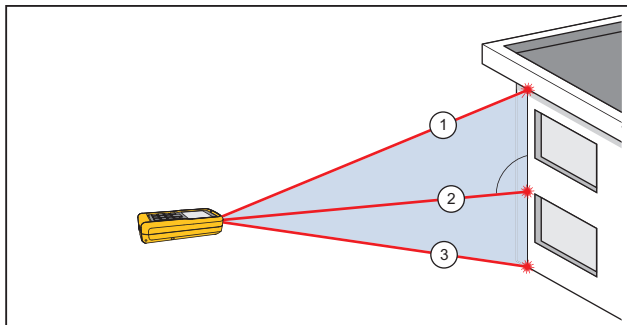

1. Push  2x.  shows on the display.
2. Point the laser at the first target. See Figure 13.

**Figure 13. Pythagoras 2**







3. Push  for the first distance (diagonal) measurement.
4. Point the laser at the second target (2).  
Make sure that the Meter is perpendicular to the wall.
5. Push  for the second distance.
6. Point the laser at the third (3) target.
7. Push  for the third distance measurement.  
The Meter shows the result in the summary line. The measured distance to the subsequent measurement shows in the second line.

To find a partial distance with three measurements (Pythagoras 3):

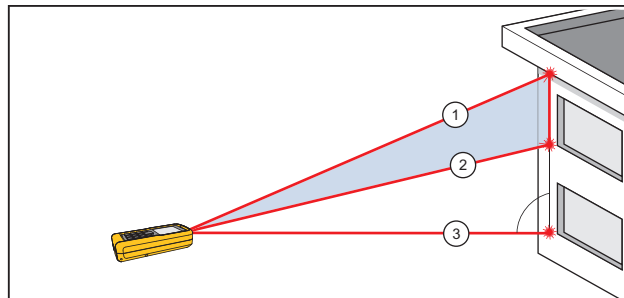

1. Push  3x. The laser turns on and  shows on the display.
2. Point at the top target (1). See Figure 14.

**Figure 14. Pythagoras 3**



3. Push . The Meter stores this measurement value.
4. Point the laser at the second diagonal target (2).
5. Push  for the second distance measurement.  
Make sure that the Meter is perpendicular to the wall.
6. Push  to trigger the bottom target (3) measurement.  
The result is the partial vertical distance between target 1 and target 2. The third measurement shows in the secondary line.

As an option, use the tracking mode on one or more targets. To use tracking mode:

1. Push and hold  for 2 seconds to start tracking mode.
2. Move the laser side to side and up and down on the ideal horizontal target point.
3. Push  to stop the tracking mode.

## Maintenance

Maintenance and calibration are not necessary for the Meter.

### Clean the Product

To keep the Meter in good condition:

- Remove dirt with a moist, soft cloth.
- Do not put in water.
- Do not use aggressive detergents or solutions.

### Batteries

Replace the batteries when  blinks in the display. See Figure 15.

*Note*

*Do not use zinc-carbon batteries.*

Figure 15. Battery Replacement

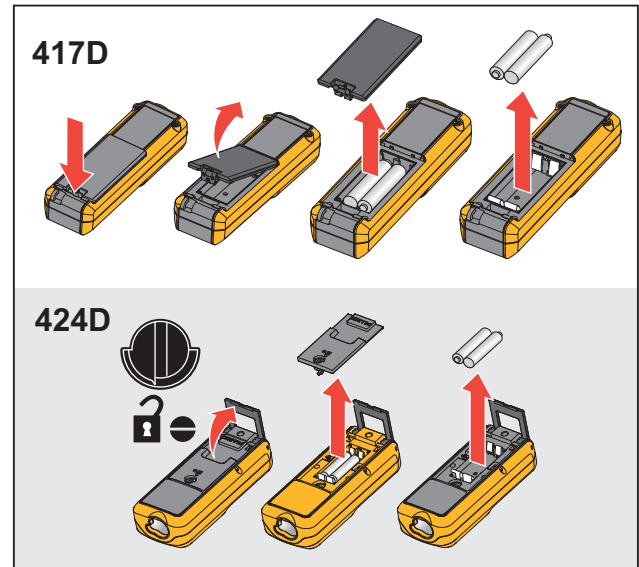



**Information or Error codes**

Table 10 is a list of all message codes that show on the display.

**Table 10. Message Codes**

Codes	Causes	Resolution
156	Transverse tilt greater than 10 °	Hold the Meter without a transverse tilt.
162	Calibration mistake	Make sure that the device is on a horizontal and flat surface. Do the calibration procedure again. If the code continues, contact Fluke.
204	Calculation error	Do the measurement again.
252	Temperature too high	Let the Meter cool down.
253	Temperature too low	Let the Meter warm up.
255	Received signal too low, measurement time too long	Change target surface (for example, white paper).
256	Received signal too high	Change target surface (for example, white paper)
257	Too much background light	Darken target surface.
258	Measurement outside of measurement range	Correct the range.
260	Laser beam interrupted	Do the measurement again.
Error	Hardware error	Turn on and turn off the device 2 to 3 times. If the symbol stays on the display, then your Meter is defective, contact Fluke.

## Specifications

	417D	424D
<b>Distance Measurement</b>		
Accuracy at favorable conditions <sup>[1]</sup>	±2.0 mm (±0.08 in) <sup>[3]</sup>	±1.0 mm (±0.04 in) <sup>[3]</sup>
Accuracy at unfavorable conditions <sup>[2]</sup>	±3.0 mm (±0.12 in) <sup>[3]</sup>	±2.0 mm (±0.08 in) <sup>[3]</sup>
Range at favorable conditions <sup>[1]</sup>	0.2 m to 40 m (0.6 ft to 131 ft)	0.05 m to 100 m (0.16 ft to 328 ft)
Range at unfavorable condition <sup>[4]</sup>	30 m / 98 ft	60 m / 196 ft
Smallest unit displayed	1 mm / 1/16 in	1 mm / 1/32 in
∅ laser point at distances	6 mm @ 10 m / 30 mm @ 50 m / 60 mm @ 100 m 0.24 in @ 33 ft / 1.2 in @ 164 ft / 2.4 in @ 328 ft	
<b>Tilt measurement</b>		
Measurement tolerance to laser beam <sup>[5]</sup>	no	±0.2 °
Measurement tolerance to case <sup>[5]</sup>	no	±0.2 °
Range	no	360 °
Compass accuracy	no	8 points (±22.5 °) <sup>[6]</sup>
<b>General</b>		
Protection class	IP54	
Automatic laser off	90 seconds	
Automatic power off	180 seconds	
Battery life (2 x AAA) 1.5 V NEDA 24A/IEC LR03	up to 3000 measurements	up to 5000 measurements
Dimensions (H x W x L)	11.6 cm x 5.3 cm x 3.3 cm (4.6 in x 2.1 in x 1.3 in)	12.7 cm x 5.6 cm x 3.3 cm (5.0 in x 2.2 in x 1.3 in)
Weight (with batteries)	113 g (4 oz)	158 g (6 oz)
<b>Temperature</b>		
Storage	-25 °C to +70 °C (-13 °F to +158 °F)	-25 °C to +70 °C (-13 °F to +158 °F)
Operation	0 °C to +40 °C (32 °F to +104 °F)	-10 °C to +50 °C (14 °F to +122 °F)
Calibration cycle	Not applicable	Tilt and Compass

	417D	424D
Maximum relative humidity	85 % at -7 °C to 50 °C (20 °F to 120 °F)	
Safety	IEC 61010-1: Pollution Degree 2	
Laser	IEC 60825-1: Class 2, 635 nm, <1 mW	
Max peak radiant output power	0.95 mW	
Wavelength	635 nm	
Pulse duration	>400 ps	
Pulse repetition frequency	320 MHz	
Beam divergence	0.16 mrad x 0.6 mrad	
EMC		
International	IEC 61326-1: Industrial Electromagnetic Environment	
	CISPR 11: Group 1, Class A	
	<i>Group 1: Equipment has intentionally generated and/or uses conductively-coupled radio frequency energy that is necessary for the internal function of the equipment itself.</i>	
	<i>Class A: Equipment is suitable for use in all establishments other than domestic and those directly connected to a low-voltage power supply network that supplies buildings used for domestic purposes. There may be potential difficulties in ensuring electromagnetic compatibility in other environments due to conducted and radiated disturbances.</i>	
KCC	Class A Equipment (Industrial Broadcasting & Communication Equipment)	
	<i>Class A: Equipment meets requirements for industrial electromagnetic wave equipment and the seller or user should take notice of it. This equipment is intended for use in business environments and not to be used in homes.</i>	
USA (FCC)	47 CFR 15 subpart B. This product is considered an exempt device per clause 15.103.	
	[1] Applies for 100 % target reflectivity (white painted wall), low background illumination, 25 °C.	
	[2] Applies for 10 % to 500 % target reflectivity, high background illumination, -10 °C to +50 °C.	
	[3] Tolerances apply from 0.05 m to 10 m with a confidence level of 95 %. The maximum tolerance may deteriorate to 0.15 mm/m between 10 m to 30 m and to 0.2 mm/m for distances above 30 m.	
	[4] Applies for 100 % target reflectivity, background illumination ~30,000 lux.	
	[5] After user calibration. Additional angle related deviation of ±0.01 ° per degree up to ±45 ° in each quadrant. Applies at room temperature. For the whole operating temperature range the maximum deviation increases by ±0.1 °.	
	[6] After calibration. Do not use the compass for navigation.	