

CERTIFIER® FA TEST SYSTEM

OPERATOR'S MANUAL

P/N 1980436, REVISION L
FEBRUARY 2017



Contents

1	INTRODUCTION	1
1.1	Parts List	3
1.2	Glossary	6
2	SETUP	7
3	OPERATION	13
3.1	Power Up	13
3.2	Keypad Functions	14
3.3	Displaying Test Measurements	14
3.4	Measurements	15
3.4.1	Flow Rate	15
3.4.2	Peak Flow Rate	16
3.4.3	Volume	16
3.4.4	Minute Volume	16
3.4.5	Stacked Volume	17
3.4.6	Oxygen Concentration	17
3.4.7	Low Pressure	17
3.4.8	Peak Pressure.....	18
3.4.9	Peep Pressure.....	18
3.4.10	Breath Rate	18
3.4.11	I:E Ratio.....	18
3.4.12	I Time	19
3.4.13	Absolute Pressure	19
3.4.14	Oxygen Concentration	19
3.5	Required Pre-test Calibrations.....	20
3.5.1	Low-Pressure Transducer Zero Calibration	20
3.5.2	Oxygen Sensor Calibration	20
3.6	Breathing Cycles and Trigger Levels.....	21
3.6.1	Inhalation and Exhalation Timing.....	21
3.6.2	Flow Trigger Levels.....	21
3.7	Display Information	22
4	TROUBLESHOOTING	25
5	MAINTENANCE	29
5.1	Replacing the Batteries (as required)	29
5.2	Replacing the Oxygen Sensor (yearly).....	29

5.3	Cleaning (as required).....	29
5.4	Factory Calibration (yearly).....	30
5.5	Return Procedure.....	30
6	SPECIFICATIONS.....	31
6.1	Physical.....	31
6.2	Environmental.....	31
6.3	Power.....	31
6.4	Test Measurements.....	31
6.5	Calibration Requirements.....	33
6.6	Compliance and Approvals.....	33

List of Figures

Figure 1.	The Certifier® FA Test System.....	2
Figure 2.	Certifier® FA Test System Parts.....	3
Figure 3.	Connecting the Controller Module to a Flow Module.....	7
Figure 4.	Connecting the Bacteria Filters to the Flow Modules.....	8
Figure 5.	Attaching Pressure Tubing to the High Flow Module.....	9
Figure 6.	Attaching the Oxygen Sensor to the High Flow Module.....	10
Figure 7.	Installing a Flow Module into the Test Circuit.....	11
Figure 8.	Certifier® FA Test System Installed in an Oxygen Concentrator Circuit.....	12
Figure 9.	Controller Module Keypad.....	14

List of Tables

Table 1.	Certifier® FA Test System Parts List.....	4
Table 2.	Keypad Functions and Operation.....	14
Table 3.	Screen Displays.....	22
Table 4.	Troubleshooting the Certifier® FA Test System.....	25
Table 5.	Cleaning Recommendations.....	29

1 Introduction

The Certifier® Flow Analyzer (FA) Test System allows you to test respiratory care or other devices. This portable tester makes it simple to test flows, volumes, pressures, oxygen concentration, and breath timing. The Certifier® FA Test System is designed for institutional, home care, field service, and laboratory settings.

Certifier® FA Test System components include:

- **Controller module:**
The keypad and display allow you to select test measurements and units for display. The controller module connects to a high or Low Flow module.
- **High Flow module:**
Measures air or 100% oxygen (O₂) over a range of flows from 0 to 300 standard liters per minute (SLPM).
- **Low Flow module:**
Measures air, 100% O₂, or 100% nitrous oxide (N₂O) over a range of flows from 0.01 to 15 SLPM with greater accuracy than the High Flow module at low flow rates.
- **Oxygen sensor:**
Used with the High Flow module, allows the High Flow module to measure O₂ concentration and other measurements for any mixture of air and O₂.

You can connect or disconnect the flow modules and oxygen sensor at any time during normal operation without interrupting tester operation. Four AA batteries power the test system. The test system conserves power by automatically turning off if none of the keys are pressed for 15 minutes. See **Section 3.1** to disable this feature.

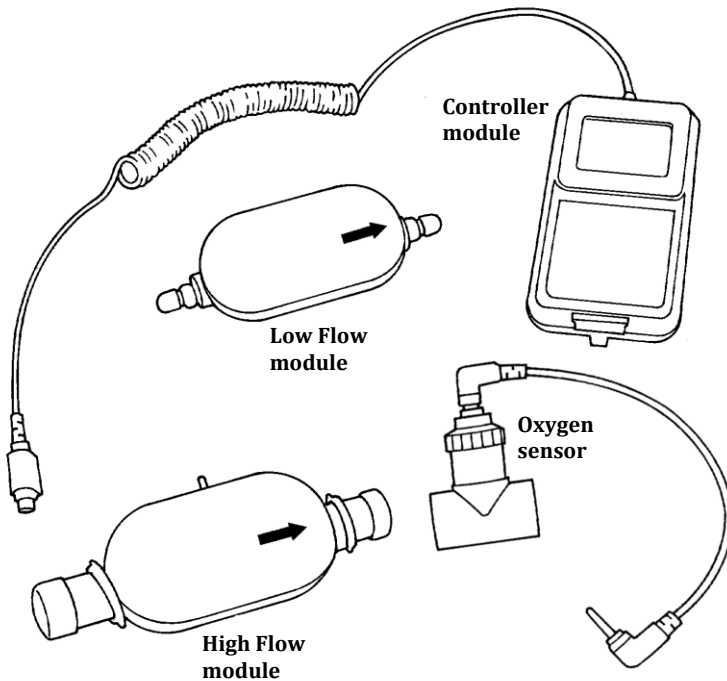

Figure 1. The Certifier® FA Test System

WARNING

- To avoid the risk of explosion, do **not** use in the presence of flammable anesthetic gases.
- Only qualified and trained service technicians are authorized to service the Certifier® FA Test System. Use only factory-approved parts and procedures to service the device.

CAUTION

- To avoid inaccurate test readings, do **not** obstruct tubing or inlet or exhaust ports, and always use dry gas.
- To avoid damage to the Certifier® FA Test System components, always use bacteria filters upstream of the flow modules, and always cap flow module ports when not in use.
- TSI flowmeters are **not** medical devices under FDA 510(k) and in no situation should be used for human measurements.

1.1 Parts List

Carefully unpack the test system components from the shipping container. Check the individual parts against the packing list and notify TSI immediately if anything is missing or damaged. Table 1 summarizes the Certifier® FA Test System components and part numbers shown in Figure 2.

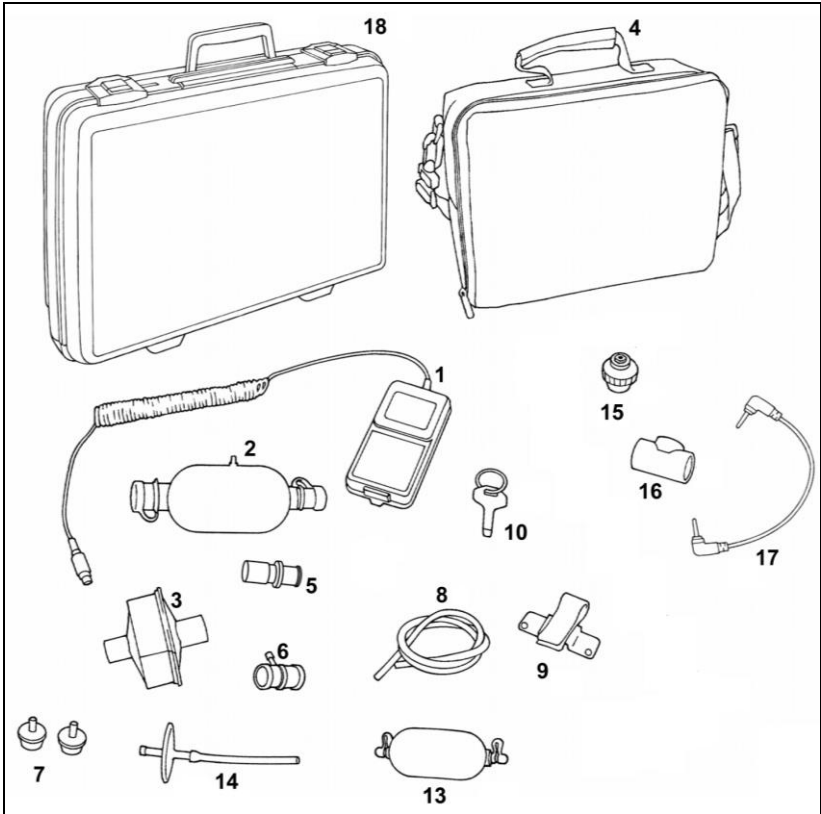

Figure 2. Certifier® FA Test System Parts

Table 1. Certifier® FA Test System Parts List

Item no.	Description	Part no.	Qty
High Flow standard kit (part no. 4070)			
1	Controller module	4078	1
2	High Flow module	4071	1
3	Bacteria filter, 22-mm x 22-mm male/female, for use with High Flow module (single use)	1602341	1
4	Soft carrying case (holds Certifier® FA Test System and accessories)	1319289	1
5	Adapter, 15-mm ID x 22-mm OD	1102093	1
6	Airway pressure fitting with screen	1611330	1
7	Adapter, 22-mm x 6-mm (for interfacing High Flow module to Low Flow filter, for use with oxygen concentrator)	1102091	2
8	Pressure tubing, 1/8-in. ID x 1/4-in. OD x 48-in. length, silicone	3002053	1
9	Mounting bracket (includes mounting bracket, screws, and Velcro strap)	1040044	1
10	Pocket driver (used to remove/install the controller module battery cover)	3012034	1
11	AA batteries (not shown)	NA	4
12	Certifier® FA Test System Operator's Manual (not shown)	1980436	1

Table 1. Certifier® FA Test System Parts List (cont)

Item no.	Description	Part no.	Qty
Low Flow standard kit (part no. 4075)			
1	Controller module	4078	1
13	Low Flow module	4074	1
14	Bacteria filter, barbed fittings, for use with Low Flow module (single use)	1040045	1
4	Soft carrying case (holds Certifier® FA Test System and accessories)	1319289	1
9	Mounting bracket (includes mounting bracket, screws, and Velcro strap)	1040044	1
10	Pocket driver (used to remove/install the controller module battery cover)	3012034	1
11	AA batteries (not shown)	NA	4
12	Certifier® FA Test System Operator's Manual (not shown)	1980436	1
High Flow module kit (optional) (part no. 4076)			
2	High Flow module	4071	1
3	Bacteria filter, 22-mm x 22-mm male/female, for use with High Flow module (single use)	1602341	1
5	Adapter, 15-mm ID x 22-mm OD	1102093	1
6	Airway pressure fitting with screen	1611330	1
7	Adapter, 22-mm x 6-mm (for interfacing High Flow module to Low Flow filter, for use with oxygen concentrator)	1102091	2
8	Pressure tubing, 1/8-in. ID x 1/4-in. OD x 48-in. length, silicone	3002053	1
9	Mounting bracket (includes mounting bracket, screws, and Velcro strap)	1040044	1

Table 1. Certifier® FA Test System Parts List (cont)

Item no.	Description	Part no.	Qty
Low Flow module kit (optional) (part no. 4072)			
13	Low Flow module	4074	1
14	Bacteria filter, barbed fittings, for use with Low Flow module (single use)	1040045	1
9	Mounting bracket (includes mounting bracket, screws, and Velcro strap)	1040044	1
Oxygen sensor kit (optional) (part no. 4073)			
15	Oxygen sensor	2917019	1
16	Threaded tee	1313118	1
17	Cable, 8-in. length	1303741	1
Other accessories (optional)			
18	Hard shell carrying case (holds Certifier® FA Test System and accessories)	1319288	1

1.2 Glossary

These labels, terms, and symbols appear on the Certifier® FA Test System:



Refer to manual: see *Certifier® FA Test System Operator's Manual* for important information.



Safety approvals for Canada by Underwriter's Laboratories Inc. (UL).

See **Section 3.7** for definitions of symbols and abbreviations that appear on the Certifier® FA display.

2 Setup

Follow these steps to set up the Certifier® FA Test System:

CAUTION

To avoid damage to the Certifier® FA Test System components, always use bacteria filters upstream of the flow modules, and always cap flow module ports when not in use.

1. Connect the controller module to a flow module (Figure 3).
To remove the cable, pull its locking connector (not the cable) from the controller module.

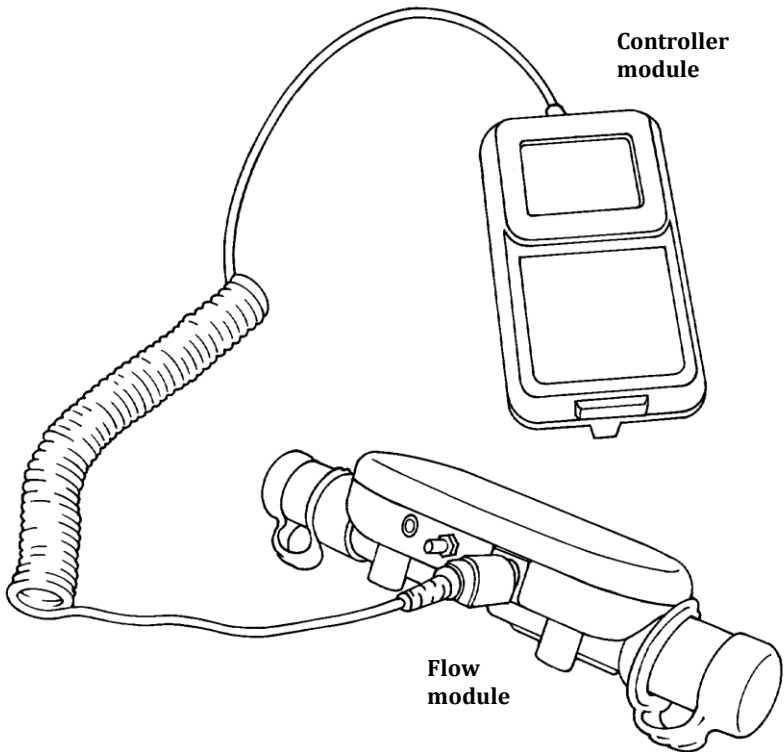

Figure 3. Connecting the Controller Module to a Flow Module

2. Attach the bacteria filter to the flow module (Figure 4).

Install the bacteria filter to the flow module inlet or upstream of all Certifier® FA Test System components. Make sure the filter is in the correct orientation by aligning the filter's flow arrow with the direction of the flow, ensuring that the filter's inlet indicator (labeled "INLET", "I", or other) faces upstream of the flow module, or that the outlet indicator (label "Patent side", "Outlet" or other) faces towards the flow module.

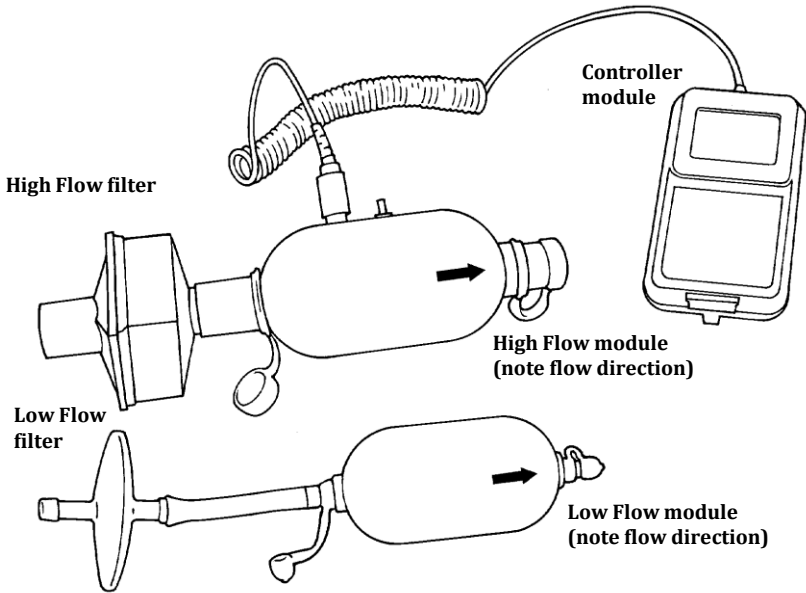

Figure 4. Connecting the Bacteria Filters to the Flow Modules

3. High Flow module only: install pressure tubing (Figure 5).
Attach one end of the pressure tubing to the low-pressure port on the flow module, and the other to the pressure port in the circuit.

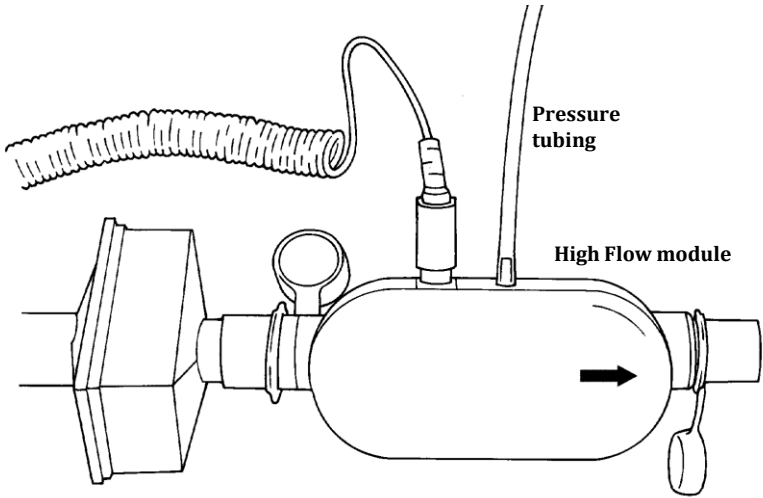

Figure 5. Attaching Pressure Tubing to the High Flow Module

4. High Flow module only: install the oxygen sensor (optional, Figure 6).

Plug the oxygen sensor cable into the High Flow module and oxygen sensor. Turn the cable collar to secure the cable to the oxygen sensor. Use the threaded tee to install the oxygen sensor into the circuit. The oxygen sensor can only connect to the High Flow module.

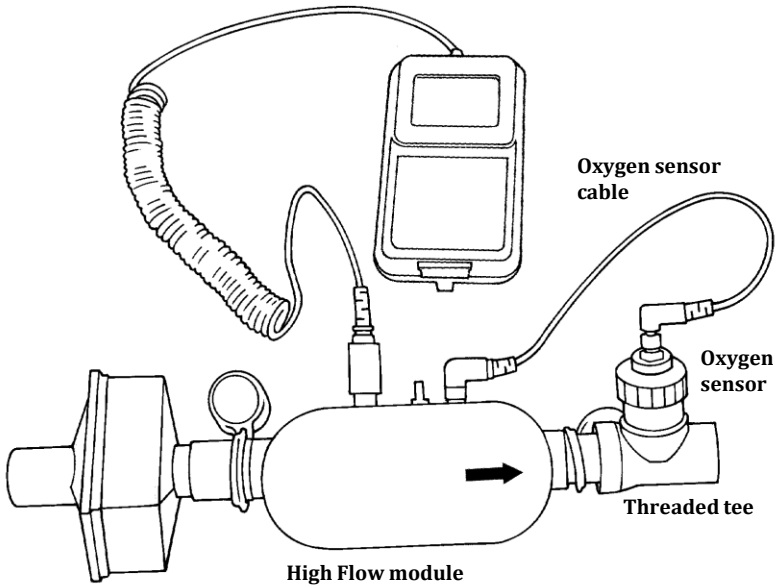

Figure 6. Attaching the Oxygen Sensor to the High Flow Module

5. Install the flow module into the test circuit (Figure 7, Figure 8).
Align the flow direction of the flow module and filter with the direction of flow through the circuit.

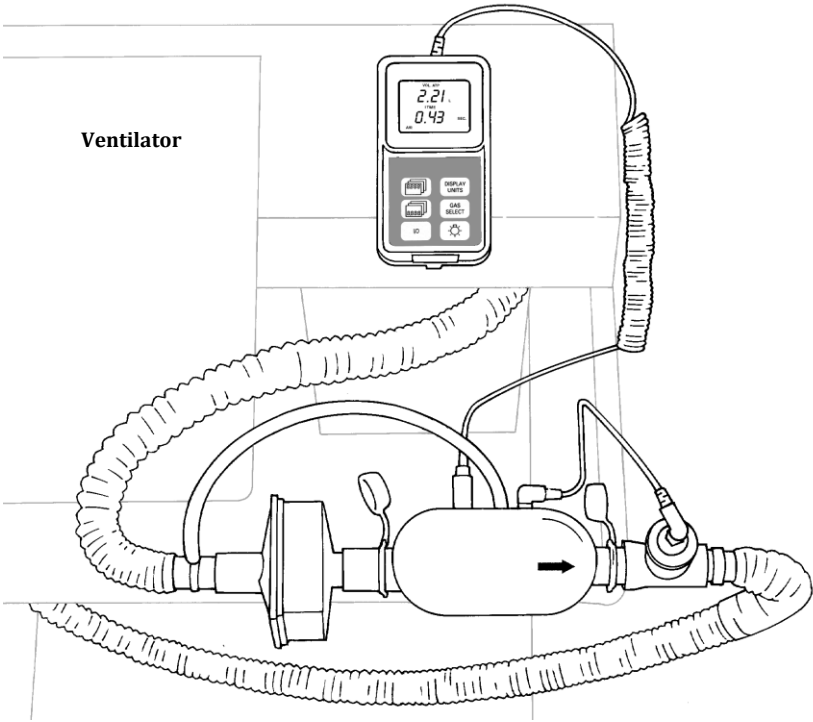

Figure 7. Installing a Flow Module into the Test Circuit

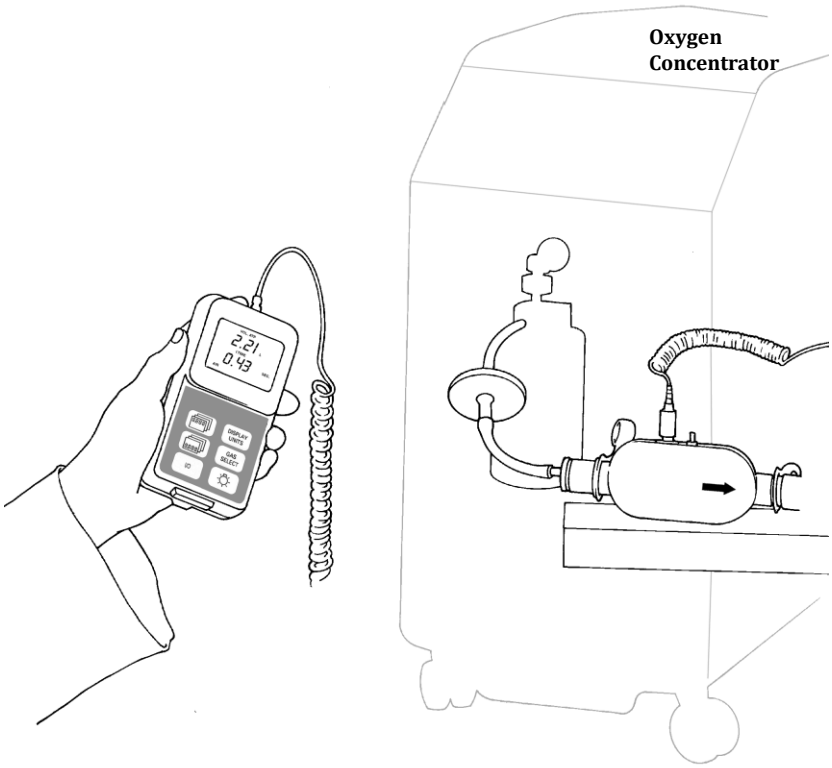



Figure 8. Certifier® FA Test System Installed in an Oxygen Concentrator Circuit

3 Operation

3.1 Power Up

Pull the protective caps from the flow module ports before powering up. Do **not** apply pressure to the flow module at power up (this ensures accurate low-pressure transducer zero calibration).

Press the **I/O (on/off)** key on the controller module to power up the Certifier[®] FA Test System (the controller module powers all of the attached Certifier[®] FA Test System components). At power up, the controller module shows information in this sequence:

1. All LCD segments light (about two seconds).
NOTE: If battery voltage is below the minimum operating level, the battery symbol lights and the controller module will turn off.
2. Firmware revision shown (about two seconds).
3. Controller module verifies connection and correct operation of the flow module and oxygen sensor (if installed). If the oxygen sensor is installed, the controller module will display a  symbol.
4. Default measurements displayed:
High Flow module: flow (top line), low pressure (bottom line).
Low Flow module: flow (top line), respiratory rate (bottom line).

CAUTION

- To ensure accurate measurements, wait about one minute for the Certifier[®] FA Test System to warm up. If environmental conditions have changed significantly, more time may be necessary.
- To avoid damage to the Certifier[®] FA Test System components, always use bacteria filters upstream of the flow modules, and always cap flow module ports when not in use.
- If liquid has penetrated any of its components, do **not** use, and return to the factory for calibration.

The test system conserves battery life by automatically turning off if none of the keys are pressed for 15 minutes. To override the automatic turn off, press the GAS SELECT key with the I/O key when turning on. The  will appear while the software revision is displayed during power up if the automatic turn off is disabled.

3.2 Keypad Functions

Table 2 summarizes the primary functions of the Certifier® FA Test System keypad (**Figure 9**).

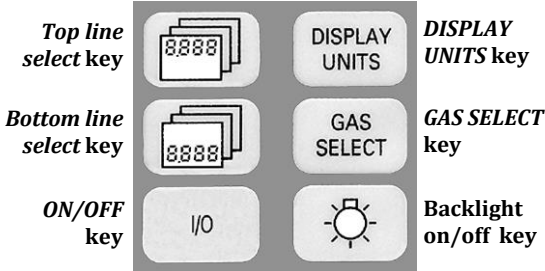

Figure 9. Controller Module Keypad

Table 2. Keypad Functions

Key		Primary Function
Top line select		Selects the measurement shown on the top line of the display.
Bottom line select		Selects the measurement shown on the bottom line of the display.
ON/Off		Turns the system on (I) or off (O).
DISPLAY UNITS		Selects the unit of measure for measurements.
GAS SELECT		Selects the supply gas type for the Certifier® FA.
Backlight on/off		Turns the controller module display backlight on or off.

3.3 Displaying Test Measurements

Follow these steps to display test measurements:

1. Set up the Certifier® FA Test System and install it into the circuit.
2. Press the **I/O (on/off)** key to power up the system.

3. Once power up is complete, press the **Top line select** and **Bottom line select** keys to select the measurements to be displayed. See **Section 3.4, Measurements**, for details on each parameter.

You can change the display selections and connect or disconnect the flow module or oxygen sensor at any time during normal operation.

- If you disconnect the flow module, the controller module display is blank.
- If you disconnect the oxygen sensor, the sensor symbol and any oxygen-related measurements are not shown on the display.
- Normal operation and display resume about one second after reconnection.

NOTE: The Certifier® FA Test System automatically updates measurements that are recalculated at every breath. The Certifier® FA Test System uses a threshold flow to determine the beginning and end of each breath. The threshold flow calculated from the last three breaths, is updated at each breath, and then is applied to the following breath. Breath measurement displays begin after two full breaths.

CAUTION

To avoid damage to the Certifier® FA Test System components, always use bacteria filters upstream of the flow modules, and always cap flow module ports when not in use.

3.4 Measurements

Measurements on Top Line of Display

The following parameters are displayed on the top line of the display.

The *Top Line Select* key  is used to scroll through parameters by momentarily pressing and then releasing the key.

3.4.1 Flow Rate

The flow rate can be displayed on the top line of control module display. Units of standard liters per minute, indicated by “SLPM”, and actual liters per minute, indicated by “LPM”, can be selected using the DISPLAY UNITS key. For the High Flow module air, O₂, and air/O₂ mixture (when oxygen sensor is attached) can be selected using the GAS SELECT key. For the Low Flow module air, O₂, and N₂O can be selected using the GAS SELECT key.

3.4.2 Peak Flow Rate

Maximum flow rate during the inhalation cycle of a breath can be displayed on the top line of the control module display. Units of standard liters per minute, indicated by “PEAK SLPM”, and actual liters per minute, indicated by “LPM”, can be selected using the DISPLAY UNITS key. See **Section 3.7, Display Information**, for definitions of these units of measure. For the High Flow module air, O₂, and air/O₂ mixtures can be selected using the GAS SELECT key. For the Low Flow module air, O₂, and N₂O can be selected using the GAS SELECT key.

NOTE: A valid flow cycle must occur for this value to be displayed. See **Section 3.6, Breathing Cycles and Trigger Levels**, for details.

3.4.3 Volume

Volume that occurs during the inhalation cycle of a breath can be displayed on the top line of the control module display. Units of actual liters, indicated by “ATP L”; standard liters, indicated by “STP L”; or liters at body temperature and pressure saturated, indicated by “BTPS L” can be selected using the DISPLAY UNITS key. See **Section 3.7, Display Information**, for definitions of these units of measure. For the High Flow module air, O₂, and air/O₂ mixture can be selected using the GAS SELECT key. For the Low Flow module air, O₂, and N₂O can be selected using the GAS SELECT key.

NOTE: A valid flow cycle must occur for this value to be displayed. See **Section 3.6, Breathing Cycles and Trigger Levels**, for details.

3.4.4 Minute Volume

Minute volume calculated from the inhalation cycle of the last breath and breath rate can be displayed on the top line of the control module display. Units of “MINUTE VOL ATP L” (actual liters), “MINUTE VOL STP L” (standard condition liters), or “MINUTE VOL BTPS L” (liters at body temperature and pressure saturated) can be selected using the DISPLAY UNITS key. See **Section 3.7, Display Information**, for definitions of these units of measure. For the High Flow module air, O₂, and air/O₂ mixture can be selected using the GAS SELECT key. For the Low Flow module air, O₂, and N₂O can be selected using the GAS SELECT key.

NOTE: A valid flow cycle must occur for this value to be displayed. See **Section 3.6, Breathing Cycles and Trigger Levels**, for details.

3.4.5 Stacked Volume

Total volume over a displayed number of inhalation cycles can be displayed on the top line of the control module display with the number of inhalation cycles displayed on the bottom line of the display. Units of actual liters, indicated by “ATP S L”; standard liters, indicated by “STP S L”; or liters at body temperature and pressure saturated, indicated by “BTPS S L” can be selected using the DISPLAY UNITS key. See **Section 3.7, Display Information**, for definitions of these units of measure. For the High Flow module air, O₂, and air/O₂ mixture can be selected using the GAS SELECT key. For the Low Flow module air, O₂, and N₂O can be selected using the GAS SELECT key.

NOTE: A valid flow cycle must occur for this value to be displayed. See **Section 3.6, Breathing Cycles and Trigger Levels**, for details.

3.4.6 Oxygen Concentration

When the oxygen sensor is attached to the High Flow module the oxygen concentration “%O₂” can be displayed on the top line of the control module display. Oxygen concentration can also be displayed on the bottom line of the display, see **Section 3.4.14**.

Daily calibrations need to be done on the oxygen sensor. See **Section 3.5.2** for instructions on oxygen sensor calibration.

NOTE: The  symbol will appear on the display when the oxygen cable is attached.

Measurements on Bottom Line of Display

The following parameters are displayed on the bottom line of the display. The *Bottom line select* key  is used to scroll through parameters by momentarily pressing and then releasing the key.

3.4.7 Low Pressure

Gauge pressure from the low-pressure port of the High Flow module can be displayed on the bottom line of the control module display. Select units of “cmH₂O” or “mmHg” by pressing and holding the DISPLAY UNITS key for at least three seconds.

For best results check the zero on the low pressure transducer before measurements. See **Section 3.5.1** for instructions on zeroing the pressure transducer.

NOTE: For distinguishing low pressure from absolute pressure, the resolution for low pressure is in 0.1 cmH₂O or mmHg and absolute pressure measurement (**Section 3.4.13**) is displayed in resolution of 1 mmHg.

3.4.8 Peak Pressure

Peak gauge pressure from the low-pressure port of the High Flow module during the inhalation cycle can be displayed on the bottom line of the control module display. Select units of “PEAK cmH₂O” or “PEAK mmHg” by pressing and holding the DISPLAY UNITS key for at least three seconds.

NOTE: A valid flow cycle must occur for this value to be displayed. See **Section 3.6, Breathing Cycles and Trigger Levels**, for details.

For best results check the zero on the low pressure transducer before measurements. See **Section 3.5.1** for instructions on zeroing the pressure transducer.

3.4.9 Peep Pressure

Positive end expiratory pressure (PEEP) from the low-pressure port of the High Flow module can be displayed on the bottom line of the control module display. Select units of “PEEP cmH₂O” or “PEEP mmHg” by pressing and holding the DISPLAY UNITS key for three seconds.

For best results check the zero on the low pressure transducer before measurements. See **Section 3.5.1** for instructions on zeroing the pressure transducer.

NOTE: A valid flow cycle must occur for this value to be displayed. See **Section 3.6, Breathing Cycles and Trigger Levels**, for details.

3.4.10 Breath Rate

The breaths per minute (BPM) can be displayed on the bottom line of the control module display.

NOTE: A valid flow cycle must occur for this value to be displayed. See **Section 3.6, Breathing Cycles and Trigger Levels**, for details.

3.4.11 I:E Ratio

The ratio of the inhalation time and exhalation time (I:E RATIO) can be displayed on the bottom line of the control module display.

NOTE: A valid flow cycle must occur for this value to be displayed. See **Section 3.6, Breathing Cycles and Trigger Levels**, for details.

NOTE: The inhalation time is defined as the time of positive inhalation flow and does **not** include the breath hold time. If the vents inhalation time includes the inhalation pause time, the Certifier® FA's I:E ratio will not match the vents I:E ratio.

3.4.12 I Time

The inhalation time (I TIME) can be displayed on the bottom line of the control module display.

NOTE: A valid flow cycle must occur for this value to be displayed. See **Section 3.6, Breathing Cycles and Trigger Levels**, for details.

NOTE: The inhalation time is defined as the time of positive inhalation flow and does not include the breath hold time. If the vents pause inhalation time includes a pause time, the Certifier® FA's I time will not match the vents I time.

3.4.13 Absolute Pressure

The absolute pressure in the flow tubes can be displayed on the bottom line of the control module display in units of “mmHg”.

NOTE: For distinguishing absolute pressure from low pressure, the resolution for absolute pressure measurement is displayed in a resolution of 1 mmHg and low pressure (**Section 3.4.7**) is displayed in a resolution of 0.1 cmH₂O or mmHg.

3.4.14 Oxygen Concentration

When the oxygen sensor is attached to the High Flow module, the oxygen concentration “%O₂” can be displayed on the bottom line of the control module display. Oxygen concentration can also be displayed on the top line of the display. See **Section 3.4.6**.

Daily calibrations need to be done on the oxygen sensor. See **Section 3.5.2** for instructions on oxygen sensor calibration.

NOTE: The  symbol will appear on the display when the oxygen cable is attached.

3.5 Required Pre-test Calibrations

3.5.1 Low-Pressure Transducer Zero Calibration

The Certifier[®] FA Test System automatically performs a low-pressure transducer zero calibration at power up. Check the low pressure zero by disconnecting the pressure tubing from the flow module *before each low-pressure measurement after initial power up* to ensure the most accurate readings. If low pressure is not reading zero, perform the following steps to zero the transducer.

1. Disconnect the pressure tubing from the flow module to expose the flow module to ambient air.
2. Momentarily press the **Bottom line select** key until low pressure (see **Section 3.4.7**) is shown on the display.
3. Press **and hold** the **Bottom line select** key for 2 to 3 seconds. The display shows **ZERO** to indicate that the zero calibration is in progress.
4. When **ZERO** is no longer displayed, the low-pressure transducer zero calibration is complete.

NOTE: The barometric pressure transducer does **not** require a zero calibration.

3.5.2 Oxygen Sensor Calibration

Follow these steps *daily* and following an altitude change or sensor replacement to calibrate the oxygen sensor:

1. Power up the Certifier[®] FA Test System with the High Flow module and oxygen sensor attached, then allow about one minute to warm up. The oxygen sensor symbol flashes if the controller module detects the sensor needs calibration or has expired.
2. Momentarily press the **Top line select** or **Bottom line select** key to show %O₂ on the display.
3. Press and hold the **GAS SELECT** key for 2 to 3 seconds. Expose the oxygen sensor to room air when you see **21.0 %O₂** and **CAL** on the display. The 21% calibration is complete when **100.0 %O₂** lights up on the top line and **CAL** flashes on the display. This can take several minutes while the oxygen concentration and sensor stabilize.
4. Expose the oxygen sensor to 100% oxygen of at least 5 liters per minute. Press and release the **GAS SELECT** key to begin the 100% calibration. **CAL** stops flashing when the 100% calibration begins.

5. If the calibration is successful, CAL disappears and the O₂ concentration is shown on the display. This can take several minutes while the oxygen concentration and sensor stabilize.
6. If the calibration is not successful (oxygen sensor symbol continues to flash, no O₂ concentration is shown), repeat the calibration. If the repeated calibration is not successful, replace the oxygen sensor and repeat.
7. Expose the oxygen sensor to room air. The Certifier® FA Test System is ready to use when the %O₂ reading returns to approximately 21%.

3.6 Breathing Cycles and Trigger Levels

The Certifier® FA uses flow rate to trigger the beginning and the end of a ventilator's inhalation cycle.

3.6.1 Inhalation and Exhalation Timing

At the beginning of the inhalation cycle the flow rate must be above the trigger flow rate for at least 0.25 milliseconds. If this time is less than 0.25 milliseconds, the Certifier® FA considers this part of the exhalation cycle. When a valid inhalation cycle is ending and the flow rate goes below the trigger level, the flow rate must remain below the trigger level for at least 0.25 milliseconds, otherwise, this period is included in the inhalation cycle.

If testing of ventilator pressure modes is needed, a test lung must be used to ensure that a long enough flow delivery time is generated. If there is not enough volume in the breathing circuit, the pressure can be generated in less than 0.25 milliseconds.

3.6.2 Flow Trigger Levels

The default trigger level is automatically set on power up at the 20% point from the minimum flow to the peak flow. For example, if the maximum flow rate is 80 L/min and the minimum flow is 5 L/min, then the trigger flow rate is set to $(80 \text{ L/min} - 5 \text{ L/min}) \times 20\% + 5 \text{ L/min} = 20 \text{ L/min}$. The 20% auto trigger level will work for most ventilators, but some manufactures may instruct you to select a different trigger level.

A 10% of the peak flow rate and trigger can also be selected. The 10% auto trigger does not use the minimum flow rate in calculating the trigger level; zero is assumed for the minimum flow rate. In the above example the trigger level would be $80 \text{ L/min} \times 10\% = 8 \text{ L/min}$.

Manually set trigger levels can also be used. Trigger can be manually set at 1, 2, 3, 4, 5, 6, 7, 8, 9, 10, 12, 15, 17, 20, 22, 24, 30, 35, or 40 L/min.

Follow these steps to view or adjust the flow trigger level.

1. Momentarily press the **Top line select** key until volume parameter is on the display, see **Section 3.4.3**.
2. Press and hold the **Top line select** key until the “trig” appears on the bottom of the display.
3. The trigger value will appear on the top line of the display which will be one of the following: “20 PEAK” (20% Auto trigger), “1 LPM”, “2 LPM”, “3 LPM”, “4 LPM”, “5 LPM”, “6 LPM”, “7 LPM”, “8 LPM”, “9 LPM”, “10 LPM”, “12 LPM”, “15 LPM”, “17 LPM”, “20 LPM”, “22 LPM”, “25 LPM”, “30 LPM”, “40 LPM”, or “10 PEAK” (10% Auto trigger).
4. To adjust the value, press and release the **Top line select** or **Bottom line select** to scroll through the list of values in step 3. After 3 seconds the new trigger level will be set and the interface module will return to displaying volume.

NOTE: The default value of 20% auto trigger is restored once the controller module is turned off.

3.7 Display Information

Table 3 describes information that can appear on the controller module screen.

Table 3. Screen Displays



Display	Meaning
---	An out-of-range measurement.
	Oxygen sensor symbol: indicates presence of oxygen sensor. Flashes to indicate that sensor must be calibrated or replaced.
	Low battery voltage symbol: indicates that batteries should be replaced.
%O ₂	Oxygen concentration can be displayed on either line if High Flow module and oxygen sensor are attached.
AIR	Air supply gas, selected using the GAS SELECT key (when High Flow or Low Flow module is attached).
AIR O ₂	Mixed air and oxygen supply gas, selected using the GAS SELECT key (when High Flow module and oxygen sensors are attached).

Table 3. Screen Displays (cont.)

Display	Meaning
ATP	Atmospheric temperature and pressure: a condition of volume measurement. The Certifier® FA Test System calculates the ATP value by applying the actual gas temperature and pressure to the STP measurement.
BPM	Breaths per minute: a unit of respiratory rate. Can be displayed on the bottom line (either High Flow or Low Flow module attached).
BTPS	Body temperature and pressure, saturated: a condition of volume measurement. The Certifier® FA Test System calculates a BTPS value by compensating the STP measurement for BTPS conditions (37 °C (98.6 °F), ambient pressure, 100% relative humidity).
CAL 100% O ₂	Oxygen sensor calibration in progress (during exposure to 100% O ₂).
CAL 21% O ₂	Oxygen sensor calibration in progress (during exposure to room air).
cmH ₂ O	Centimeters of water: a unit of pressure.
I TIME	Inspiratory time (in seconds). Can be displayed on the bottom line (either High Flow or Low Flow module attached).
I:E RATIO	Ratio of inspiratory time to expiratory time, can be displayed on the bottom line (when High Flow or Low Flow module is attached).
L	Liter: a unit of volume.
LPM	Liters per minute: a unit of flow. The Certifier® FA Test System calculates the LPM value by applying the actual gas temperature and pressure to the SLPM measurement.
MINUTE VOL	Minute volume: an estimate of exhaled volume for the next 60 seconds, based on the current breath. Can be displayed on the bottom line (when High Flow or Low Flow module is attached).
mmHg	Millimeters of mercury: a unit of pressure.
N ₂ O	100% nitrous oxide supply gas, selected using the GAS SELECT key (if Low Flow module is attached).

Table 3. Screen Displays (cont.)

Display	Meaning
O ₂	100% oxygen supply gas, selected using the GAS SELECT key (when High Flow or Low Flow module is attached).
PEAK	Peak flow or pressure. Peak flow can be displayed on top line (when High Flow or Low Flow module is attached). Peak pressure can be displayed on bottom line (if High Flow module is attached).
PEEP	Positive end expiratory pressure: the minimum pressure measured in the circuit throughout the breath cycle. Can be displayed on the bottom line (if High Flow module attached).
REV	Software revision level, displayed at power up.
S	Stacked volume: a cumulative volume measurement for consecutive breaths. The top line shows the cumulative volume and the bottom line shows the number of consecutive breaths.
SEC	Seconds, a unit of time for I TIME measurements.
SLPM	Standard liters per minute: a unit of flow. The Certifier [®] FA Test System measures flows in SLPM. Standard conditions are defined as 21.1 °C (70 °F) at 101.3 kPa (14.7 psia).
STP	Standard temperature and pressure: a condition of volume measurement. The Certifier [®] FA Test System measures volumes at STP. Standard conditions are defined as 21.1 °C (70 °F) at 101.3 kPa (14.7 psia).
VOL	Volume: the exhaled volume for the most recent breath. Can be displayed on the top line (either High Flow or Low Flow module attached).
ZERO	Low-pressure transducer zero calibration in progress.

4 Troubleshooting

Table 4 lists the symptoms, possible causes, and recommended corrective actions for problems you may encounter with the Certifier® FA Test System. If the symptom is not listed, or if none of the recommended corrective actions solves the problem, please contact TSI Customer Support at (800) 874-2811 or 651-490-2811.

Table 4. Troubleshooting the Certifier® FA Test System

Symptom	Possible Cause	Corrective Action
Controller module won't turn on, or turns on and off.	Batteries are depleted or installed backwards.	Check that batteries are installed correctly. Replace batteries.
Measurements aren't displayed even though controller module is on.	Flow module isn't connected to controller module.	Connect flow module to controller module.
'---' is shown on display.	Measurement is out of range.	Check range for displayed measurement, and only make measurements within that range.
Flow rate does not read zero when no gas flowing (Especially when set to N ₂ O).	Meter was not purged with gas displayed on the controller.	Purge meter with gas displayed on controller or press gas select key to change to desired gas.
Unable to disconnect flow module from controller module.	Pulling on the cable rather than the connector.	Pull the locking connector (not the cable) to disengage connector lock.
Can't display %O ₂ .	Oxygen sensor not connected. Look for oxygen sensor symbol,  .	Connect oxygen sensor cable to High Flow module and oxygen sensor.

Table 4. Troubleshooting the Certifier® FA Test System (cont.)

Symptom	Possible Cause	Corrective Action
Can't select AIR O ₂ mixtures.	Oxygen sensor not connected. Look for oxygen sensor symbol,  .	Connect oxygen sensor cable to High Flow module and oxygen sensor.
Volume, minute volume, peak flow, peak pressure, PEEP, respiratory rate, or I:E ratio measurement isn't updated.	<p>Less than two consecutive full breaths have been supplied to flow module, or flow is not supplied as a breathing waveform.</p> <p>Bias flow is greater than auto trigger level.</p> <p>Inhalation cycle is less than 0.25 milliseconds</p> <p>Testing pressure mode on ventilator and no test lung attached.</p>	<p>Wait for at least two consecutive full breaths to be supplied to the flow module.</p> <p>Ensure that flow is supplied as a breathing waveform.</p> <p>Manually set flow trigger level.</p> <p>Certifier® FA cannot measure shorter than 0.25 millisecond flow delivery.</p> <p>Use a test lung so that at least 0.25 milliseconds of flow delivery is generated to generate pressure.</p>
Can't change measurement units.	Measurement isn't displayed while changing units.	Press the Top line select or the Bottom line select key to display measurement, then press the DISPLAY UNITS key to change units.
Can't zero low-pressure transducer.	Transducer is connected to a pressure source.	Disconnect pressure tubing from flow module, then zero low-pressure transducer.
Can't zero barometric pressure transducer.	Barometric pressure transducer does not require a zero calibration.	Resume normal system operation.

Table 4. Troubleshooting the Certifier® FA Test System (cont.)

Symptom	Possible Cause	Corrective Action
Oxygen sensor calibration takes longer than 5 minutes.	21% oxygen and/or 100% oxygen not supplied for calibration. Flow of 100% oxygen is too low.	Verify that calibration gases are 21% oxygen and 100% oxygen and repeat calibration. Increase flow of 100% oxygen to at least 5 SLPM and repeat calibration.
Oxygen sensor calibration fails.	21% oxygen and/or 100% oxygen not supplied for calibration. Oxygen sensor is expired.	Verify that calibration gases are 21% oxygen and 100% oxygen and repeat calibration. Replace oxygen sensor.

5 Maintenance

5.1 Replacing the Batteries (as required)

Replace the batteries when the low battery voltage symbol is displayed or instrument will not power up.

1. Turn off the controller module.
2. Use the pocket driver tool (supplied) to loosen the screw that holds the battery cover on the controller module back panel.
3. Remove the old batteries from the battery compartment, and install new batteries noting the polarity indicators.
4. Reinstall the battery cover and tighten the screw to hold the cover to the controller module.

5.2 Replacing the Oxygen Sensor (yearly)

The oxygen sensor will function for one year of normal operation if use begins before the expiration date. Replace the oxygen sensor every year of normal use, or if the sensor cannot be calibrated or sensor readings are erratic.

5.3 Cleaning (as required)

Table 5 summarizes recommended cleaning methods for Certifier® FA Test System components.

Table 5. Cleaning Recommendations

Component	Cleaning
<ul style="list-style-type: none">▪ Controller module▪ Flow modules▪ Carrying cases▪ Oxygen sensor▪ Oxygen sensor cables	Clean exterior as required with a clean cloth and isopropyl alcohol, hydrogen peroxide (3%), or ammonia (15%).
<ul style="list-style-type: none">▪ Tee▪ Adapters	Steam autoclave after contact with any non-sterile breathing circuit components, and discard if any damage is visible.
<ul style="list-style-type: none">▪ Single use filters (high and Low Flow modules)	Discard after contact with any non-sterile breathing circuit components or if damage is visible.

6 Specifications

NOTE: Specifications are subject to change without notice.

6.1 Physical

Dimensions	Controller module: 13.2 cm x 7 cm x 3.3 cm (5.2 in. x 2.8 in. x 1.3 in.). High Flow module: 18 cm x 6.6 cm x 4 cm (7.1 in. x 2.6 in. x 1.6 in.). Low Flow module: 12.7 cm x 5.1 cm x 2.8 cm (5.0 in. x 2.0 in. x 1.1 in.).
Flow connectors	High Flow module: <ul style="list-style-type: none"> flow inlet: 22-mm female ISO taper. flow outlet: 22-mm male ISO taper. Low Flow module: <ul style="list-style-type: none"> flow inlet: 0.25-in. barb. flow outlet: 0.25-in. barb.
Weight	Approximately 1.36 kg (3 lb) for the standard kits.

6.2 Environmental

Temperature	Operating: 5 to 40 °C (41 to 104 °F). 15 to 80% relative humidity from 5 to 31 °C decreasing linearly to 15 to 50% relative humidity at 40 °C. Storage: -40 to 70 °C (-40 to 158 °F) at 10 to 95% relative humidity.
Atmospheric Pressure	Operating: 57.1 to 106 kPa (8.28 to 15.37 psia). Storage: 50 to 106 kPa (7.25 to 15.37 psia).
Conditions	Indoor Use Operating Altitude up to 4000 m (13,000 ft) Pollution degree I or II

6.3 Power

Battery life	15 to 20 hours.
Battery type	Four commercially available AA batteries.

6.4 Test Measurements (see notes at end of section)

Measurement	High Flow Module	Low Flow Module
Flow and Peak Flow		
Range	0 to 300.0 SLPM.	0.01 to 15.00 SLPM.
Accuracy	Air and oxygen: ± 2% of reading or ± 0.075 SLPM, whichever is greater. Air/oxygen mixtures: ± 4% of reading or ± 0.1 SLPM, whichever is greater.	Air and oxygen: ± 2% of reading or ± 0.010 SLPM, whichever is greater. Nitrous oxide: ± 4% of reading or ± 0.025 SLPM, whichever is greater.

Measurement	High Flow Module	Low Flow Module
Pressure drop	Maximum between inlet and outlet ports at 101.3 kPa (14.7 psia) including filter: 0.50 cmH ₂ O at 20 SLPM, 1.50 cmH ₂ O at 50 SLPM, 5.0 cmH ₂ O at 100 SLPM, 30.0 cmH ₂ O at 300 SLPM.	Maximum between inlet and outlet ports at 101.3 kPa (14.7 psia) including filter: 4 cmH ₂ O at 2 SLPM, 16 cmH ₂ O at 5 SLPM, 45 cmH ₂ O at 10 SLPM, 85 cmH ₂ O at 15 SLPM.
Volume		
Range	0.01 to 10.0 L STP.	0 to 9.999 L STP.
Accuracy	Air and oxygen: ± 2% of reading plus 0.020 L STP Air/oxygen mixtures: ± 4% of reading plus 0.020 L STP.	Air and oxygen: ± 2% of reading or ± 0.010 L STP, whichever is greater. Nitrous oxide: ± 4% of reading or ± 0.010 L STP, whichever is greater.
Minute Volume		
Range	0 to 99.00 L STP.	0 to 9.999 L STP.
Accuracy	± 7% of reading.	± 7% of reading.
Stacked Volume		
Range	0 to 99.00 L STP.	0 to 9.999 L STP.
Accuracy	Air and oxygen: ± 2% of reading plus 0.020 L STP Air/oxygen mixtures: ± 4% of reading plus 0.020 L STP.	Air and oxygen: ± 2% of reading or ± 0.010 L STP, whichever is greater. Nitrous oxide: ± 4% of reading or ± 0.010 L STP, whichever is greater.
Inspiratory Time		
Range	0.25 to 60.00 seconds.	0.25 to 60.00 seconds.
Accuracy	± 0.01 seconds.	± 0.01 seconds.
I:E Ratio		
Range	1:100.0 to 100.0:1.	1:15.0 to 15.0:1.
Accuracy	± 5% of reading.	± 5% of reading.
Respiratory Rate		
Range	0.5 to 120.0 breaths per minute.	0.5 to 120.0 breaths per minute.
Accuracy	± 5% of reading.	± 5% of reading.
Low Pressure		
Range	-25.0 to 150.0 cmH ₂ O. (-18.4 to 110 mmHg)	Not applicable.
Accuracy	± 0.75% of reading or ± 0.20 cmH ₂ O (0.15 mmHg), whichever is greater.	Not applicable.

Measurement	High Flow Module	Low Flow Module
Peak & PEEP Low Pressure		
Range	0 to 150.0 cmH ₂ O. (0 to 110 mmHg)	Not applicable.
Accuracy	± 0.75% of reading or ± 0.20 cmH ₂ O (0.15 mmHg), whichever is greater.	Not applicable.
Barometric Pressure		
Range	375 to 1500 mmHg.	375 to 1500 mmHg.
Accuracy	± 8 mmHg.	± 8 mmHg.
Oxygen Concentration		
Range	0 to 100.0% O ₂ .	Not applicable.
Accuracy	± 2% O ₂ at daily calibration conditions.	Not applicable.
NOTES		
<ol style="list-style-type: none"> Standard conditions are defined as 21.1 °C (70 °F) and 101.3 kPa (14.7 psia). Flow and volume accuracy is applicable in SLPM or STP mode only. The temperature of the gas and the ambient air must be within ± 10 °C (± 18 °F) of each other and the gas must be less than 30% relative humidity at 21.1 °C (70 °F). Flow and volume accuracy de-rating: ± 0.075% of reading per 1 °C (1.8 °F) away from 21.1 °C (70 °F); ± 0.015% of reading per 1.03 kPa (0.15 psia) above 101.3 kPa (14.7 psia); ± 0.022% of reading per 1.03 kPa (0.15 psia) below 101.3 kPa (14.7 psia); ± 0.07% of reading per 1% relative humidity above 30% relative humidity. 		

6.5 Calibration Requirements

Flow modules	Factory calibration every year for normal use under normal conditions using the filter(s) provided.
Controller module	No calibration required.
Oxygen sensor	Daily, following sensor replacement or as required.

6.6 Compliance and Approvals

Complies with these standards:	<ul style="list-style-type: none"> CAN/CSA-C22.2 No. 1010. 1-92: Canadian Standard for the Safety of Electrical Equipment for Measurement, Control and Laboratory Use, Part 1. EN 55011 (1991) Class B, CISPR 11 (1990) Class B, FCC (CFR 47, Part 15) Class B: Emissions, Radiated and Conducted. EMC Directive 89/336/ECC, EN 61326-1 (1997 plus Amendment A1 1998), IEC 1000-4-2 (1995), EN 61000-4-2, IEC 1000-4-3 (1995), EN 61000-4-3: Immunity.
--------------------------------	---