

3490

ANALOG MΩ HiTESTER (Insulation and Continuity Tester)

Instruction Manual

EN

Dec. 2023 Revised edition 13
3490A981-13



HIOKI



All regional
contact
information

HIOKI E.E. CORPORATION

2309 EN

Edited and published by HIOKI E.E. CORPORATION

Printed in Japan

- Contents subject to change without notice.
- This document contains copyrighted content.
- It is prohibited to copy, reproduce, or modify the content of this document without permission.
- Company names, product names, etc. mentioned in this document are trademarks or registered trademarks of their respective companies.

Warranty

Warranty malfunctions occurring under conditions of normal use in conformity with the Instruction Manual and Product Precautionary Markings will be repaired free of charge. This warranty is valid for a period of three (3) years from the date of purchase. Please contact the distributor from which you purchased the product for further information on warranty provisions.

Introduction

Thank you for purchasing the HIOKI Model 3490 ANALOG MΩ HiTESTER. To obtain maximum performance from the instrument, please read this manual first, and keep it handy for future reference.

Overview

The 3 Ω range of this instrument can be used for both the Continuity Test on protective conductors used in electrical installations of buildings, and the protective conductor resistance measurement test approved by IEC60364.

The 30 Ω range is also optimal for the Polarity and Circuit Connection Testing for Indoor Wiring approved by AS/NZS3017, guidelines for tests and inspections on electrical installations in the Oceania region. This instrument is not designed for the production line and is not suitable for that purpose. Please use the ST5520 Insulation Tester for the production line.

Inspection and Maintenance

Initial Inspection

When you receive the instrument, inspect it carefully to ensure that no damage occurred during shipping. If damage is evident, or if it fails to operate according to the specifications, contact your dealer.

Maintenance and Service

- To clean the instrument, wipe it gently with a soft cloth moistened with water or mild detergent. Never use solvents such as benzene, alcohol, acetone, ether, ketones, thinners or gasoline, as they can deform and discolor the case.
- If the instrument seems to be malfunctioning, contact your dealer or Hioki representative.
- Pack the instrument so that it will not sustain damage during shipping, and include a description of existing damage. We cannot accept responsibility for damage incurred during shipping.

Safety

This instrument is designed to conform to IEC 61010 Safety Standards and has been thoroughly tested for safety prior to shipment. However, using the instrument in a way not described in this manual may negate the provided safety features. Carefully read the following safety notes before using the instrument.

⚠ DANGER

Mishandling instrument could result in bodily injury or even death, as well as damage to the instrument. Familiarize yourself with the instructions and precautions in this manual before use.

Safety Symbol

	Indicates cautions and hazards. When the symbol is printed on the instrument, refer to a corresponding topic in the Instruction Manual.
	Indicates that dangerous voltage may be present at this terminal.
	Indicates a double-insulated device.
	Indicates AC (Alternating Current).
	Indicates DC (Direct Current).

The following symbols in this manual indicate the relative importance of cautions and warnings.

⚠ DANGER	Indicates that incorrect operation presents an extreme hazard that could result in serious injury or death to the user.
⚠ WARNING	Indicates that incorrect operation presents a significant hazard that could result in serious injury or death to the user.
⚠ CAUTION	Indicates that incorrect operation presents a possibility of injury to the user or damage to the instrument.

Other Symbol

	Indicates a prohibited action.
	Indicates that the product complies with standards imposed by EU directives.

Measurement categories

This instrument complies with CAT III safety requirements. To ensure safe operation of measurement instruments, IEC 60664 establishes safety standards for various electrical environments, categorized as CAT II to CAT IV, and called overvoltage categories. These are defined as follows.

CAT II :Primary electrical circuits in equipment connected to an AC electrical outlet by a power cord (portable tools, household appliances, etc.). CAT II covers directly measuring electrical outlet receptacles.

CAT III:Primary electrical circuits of heavy equipment (fixed installations) connected directly to the distribution panel, and feeders from the distribution panel to outlets.

CAT IV:The circuit from the service drop to the service entrance, and to the power meter and primary overcurrent protection device (distribution panel).

Using a measurement instrument in an environment designated with a higher-numbered category than that for which the instrument is rated could result in a severe accident, and must be carefully avoided. Use of a measurement instrument that is not CAT-rated in CAT II to CAT IV measurement applications could result in a severe accident, and must be carefully avoided.

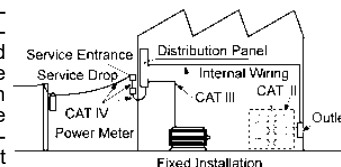

Usage Notes

Follow these precautions to ensure safe operation and to obtain the full benefits of the various functions.

Preliminary Checks

Before using the instrument the first time, verify that it operates normally to ensure that no damage occurred during storage or shipping. If you find any damage, contact your dealer.

DANGER

- 1000 V or 600 V may be labeled depending on the supplied test leads, but this is the rating of the test lead and not the rating performance of the 3490. Please refer to the Specifications for the rating performance of this instrument.
- Before attaching to or removing the test lead from the instrument, please remove the Test Lead from the tested object and turn the function switch to OFF.

WARNING

- Do not use the instrument where it may be exposed to corrosive or combustible gases. The instrument may be damaged or cause an explosion.
- Do not use the instrument where it may be exposed to oil, chemicals, or solvents. Contact with these substances may cause cracking in the instrument, resulting in damage or electric shock.
- Do not allow the instrument to get wet, and do not take measurements with wet hands. This may cause an electric shock.
- Please only use batteries for electrical supply. Any other electrical supply may damage the instrument and tested object and cause electric shock.
- Before using the instrument, make sure that the insulation on the test leads is undamaged and that no bare conductors are improperly exposed. Using the instrument in such conditions could cause an electric shock, so contact your dealer or Hioki representative for replacements.
- To prevent an electric shock, do not exceed the every rating shown on either the instrument or each test lead, whichever is worse.

CAUTION

- This instrument is designed for use indoors. It can be operated at temperatures between 0 and 50°C without degrading safety.
- Do not store or use the instrument where it could be exposed to direct sunlight, high temperature or humidity, or condensation. Under such conditions, the instrument may be damaged and insulation may deteriorate so that it no longer meets specifications.
- To prevent accidents, please use the supplied L9787 Test Leads (or the optional L9788-10).
- To avoid damage to the instrument, protect it from physical shock when transporting and handling. Be especially careful to avoid physical shock from dropping.
- If the protective functions of the instrument are damaged, either remove it from service or mark it clearly so that others do not use it inadvertently.
- Although this instrument is dust resistant, it is not completely dust- or waterproof. To prevent possible damage, avoid using in dusty or wet environments.
- The protection rating for the enclosure of this device (based on EN60529) is *IP40.
- Removable sleeves are attached to the metal pins at the ends of the test leads. To prevent a short circuit accident, be sure to use the test leads with the sleeves attached when performing measurements in the CAT III measurement category. Remove the sleeves from the test leads when performing measurements in the CAT II measurement category. For details on measurement categories, see "Measurement categories" in the instruction manual.
- When performing measurements with the sleeves attached, be careful to avoid damaging the sleeves. If the sleeves are inadvertently removed during measurement, be especially careful in handling the test leads to avoid electric shock.
- To prevent an electric shock accident, confirm that the white or red portion (insulation layer) inside the cable is not exposed. If a color inside the cable is exposed, do not use the cable.
- To avoid battery depletion, turn the function selector OFF after use. Battery may drain if the switch is not turned to OFF.
- The test lead plug comes with a protective cap. Please remove this cap before attaching it to the instrument.
- After measurement, please turn the function switch to OFF. The cover will not close if the switch is not at OFF.

*IP40

4: Protected against access to hazardous parts with wire measuring 1.0 mm in diameter. The equipment inside the enclosure is protected against entry by solid foreign objects larger than 1.0 mm in diameter.

0: The equipment inside the enclosure is not protected against the harmful effects of water.

Specifications

Standard Specifications

Functions	<ul style="list-style-type: none"> • Insulation Resistance measurement: DC voltage supply, current detection • Low resistance measurement: DC current supply, voltage detection • AC Voltage measurement: Average responding type • Effective battery range indicator: Built-in battery power indicator • Live circuit indicator: lights up when voltage is detected between LINE terminal and EARTH terminal
Automatic electric discharge	Automatically discharges the electric charge still present in the capacitance of the test object after the Insulation resistance measurement test. Discharge resistance: 800 kΩ or less Maximum capacitive load: 5 μF Discharge time: Max.30 s (when connected to 5 μF)
Auto Power Save	When the function switch is not at OFF, the power will only go off automatically 15 minutes after the last live circuit alert has been displayed.
Indicator	Indicator: Meter (Internal magnet type taut band method) Indicator light • Light device: LED • Light automatic OFF function: Light goes off about 3 minutes after MEASURE key is switched to OFF or when LIGHT key is pressed.

General Specifications

Guaranteed accuracy period	1 year
Product warranty period	3 years
Operating Temperature & Humidity	0°C to 40°C (32°F to 104°F), 90% RH or lower (non-condensation) 40°C to 50°C (104°F to 122°F), at 50°C and below relative with linear decrease up to 50% RH
Operating Environment	Indoors, Pollution Degree 2, Altitude up to 2000 m (6562-ft.)
Storage Temperature & Humidity	-10°C to 50°C (14°F to 122°F), 90% RH or lower (non-condensation)
Degree of protection	IP40(Excluding terminals)
Maximum rated voltage to terminal	600 V AC (AC voltage function)
Maximum rated voltage to earth	600 V AC, Measurement Category III, Anticipated Transient Overvoltage: 6000 V
Dielectric strength	7060 V AC, 50 Hz/60 Hz, Measurement terminals - electrical enclosure, during 1 minute, current sensitivity 1 mA
Power supply	Rated supply voltage: 1.5 V DC × 4, LR6 alkaline battery × 4 1.2 V DC × 4, HR6 nickel-metal hydride batteries × 4
Maximum rated power	3 VA
Continuous operating time	Approx. 20 hours (at 500 V range, no load)
Drop Proof	On concrete: 1 m/1 time
Dimensions (excluding protrusions)	Approx. 159W×177H×53D mm (6.26"W×6.97"D×2.09"D)
Mass	Approx. 610g (21.5oz) (including battery, not including test lead)
Accessories	L9787 Test Lead, Instruction manual, Shoulder strap, LR6 alkaline battery × 4
Replacements	FF0.5AH/ 1000 V (70 172 40.0.500: SIBA) (Very fast acting, arc extinction type, high rupturing capacity type) L9788-10 Test Lead with Remote Switch (Red), L9787-91 Breaker Pin, L9788-92 Breaker Pin, 9804-02 Magnetic Adapter, L9787 Test Lead, L9788-90 Tip Pin, L9788-11 Test Lead Set with Remote Switch
Options	Safety EN61010 EMC EN61326
Standards	Measuring equipment for Low voltage distribution system EN61557-1/-2/-4* (the 3 Ω is applicable to part 4) *Subclause 4.3 of Part 4 (Interchanging of test leads) is not applicable when the L9788-10 is used.

Measurement functions

Guaranteed for one year at 23°C±5°C (73°F ±9°F) and 90% RH.

Insulation Resistance Measurement

Rated output voltage	250 VDC	500 VDC	1000 VDC
Effective maximum indicated value	100 MΩ		4000 MΩ
Center scale value	1 MΩ		50 MΩ
Response time	Within 3 sec. (∞ → center value, ∞ → 0 MΩ)		
Possible number of measurements	1000 times (at 0.25 MΩ)	1000 times (at 0.5 MΩ)	1000 times (at 1 MΩ)
Effect of position (Horizontal ±90°)	±4% of scale length		
Overload protection	660 VAC (10 sec.)		
Accuracy			
1st effective measuring range	0.05 to 50 MΩ		2 to 1000 MΩ
	±2% of scale length		
2nd effective measuring range	0.01 to 0.05 MΩ 50 to 100 MΩ		0.5 to 2 MΩ 1000 to 4000 MΩ
	±2% of scale length		
0 MΩ, ∞ scale	±2% of scale length		
Measurement terminal voltage characteristic			
Open circuit voltage (when no load is applied)	1 to 1.2 times of rated output voltage		
Lower limit measurement resistance value to be maintained rated output voltage	0.25 MΩ	0.5 MΩ	1 MΩ
Rated current	1 mA (Tolerance: 1 to 1.2 times of the rating value) (The current flow when rated output voltage is maintained)		
Short circuit current	1.2 mA max.		

Effect of temperature		
1st effective measuring range		±1.5% of scale length
2nd effective measuring range		±1.5% of scale length
0 MΩ, ∞ scale		±1.5% of scale length
Resistance Measurement		
Ranges	3 Ω	30 Ω
Effective maximum indicated value	3 Ω	30 Ω
Center scale value	1.5 Ω	15 Ω
Measuring range	0 to 3 Ω	0 to 30 Ω
Accuracy	±0.09 Ω	±0.9 Ω
Open-circuit voltage	4.1 to 6.9 V	
Measuring current	200 mA DC or more	20 mA DC or more
Possible number of measurements (5sec ON, 25sec OFF)	1000 times (at 1 Ω)	1000 times (at 10 Ω)
Effect of temperature	±3% of effective maximum scale value	
Effect of position (Horizontal ±90°)	±4% of effective maximum scale value	
Overload protection	720 VAC (10 sec., by Fuse)	
AC Voltage Measurement		
Measuring range	0 to 600 V	
Accuracy	±5% of maximum scale value	
Frequency range	50/60 Hz	
Input resistance	100 kΩ or more (50Hz/60Hz)	
Effect of temperature	±5% of maximum scale value	
Effect of position (Horizontal ±90°)	±4% of maximum scale value	
Overload protection	660 VAC (10 s)	

- Effect of temperature is applicable to the temperature range other than 18°C to 28°C
- Accuracy for the low resistance measurement is applicable after zero adjustment (when the temperature changes more than ±1°C after zero adjustment, another zero adjustment is necessary)
- Accuracy is applicable after adjustment by meter movement zero adjuster

Names and Functions of Parts

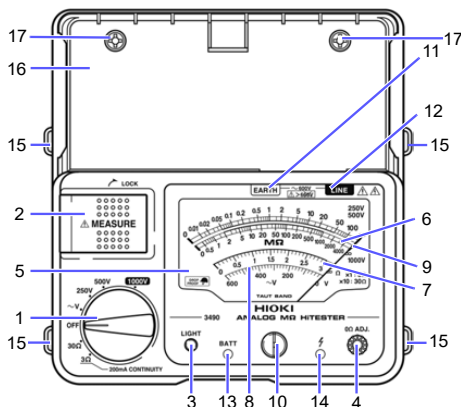

- Function switch: Select measurement functions
- MEASURE key: Press to measure insulation resistance or low resistance.
- LIGHT key: Press this key to turn on the light
- 0Ω.ADJ Knob: Use in zero adjustment before low resistance measurement
- Scale plate
- Insulation resistance scale: Read blue scale at 250 V, 500 V and red scale at 1000 V
- Low resistance scale: Read as it is at 3 Ω and multiply by 10 at 30 Ω
- AC voltage scale
- Indicator needle
- Meter movement zero adjuster
- EARTH terminal: Connect the black test lead
- LINE terminal: Connect the red test lead
- Effective battery range indicator: Green when battery power is high, red when battery power is decreasing and no light when battery is drained
- Live circuit indicator: Lights up when voltage remains between input terminals
- Strap opening: Pass the supplied strap through the opening
- Test lead storage space: Stores the test lead without having to remove it from the measurement terminal
- Sleeve stand: Attach the sleeve removed from the tip of the test lead.

Options

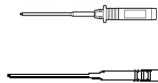

- **L9787-91 Breaker Pin**
(Pin length 70 mm and 48 mm from the tip has width 2.5 mm. The rest have width 3.8 mm.) Breaker pin for L9787.
- **L9788-92 Breaker Pin**
(Pin length 123 mm and 65 mm from the tip has width 2.6 mm.) Breaker pin for L9788-10.

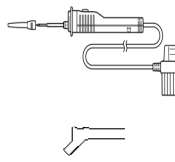

- **L9788-10 Test Lead with Remote Switch (Red) (1.2 m)**
Test lead with MEASURE key for the line side measurement. Measurement can be started by pressing the key. There is a light at the tip which can be switched on by pressing the LIGHT key on the 3490. Earth side lead is not attached.
- **9804-02 Magnetic Adaptor**
(Ø11 mm Corresponding standard screw: M6 Button head screw)
Adaptor for connecting a Test lead to the round head screw by means of magnetism. The tip of adaptor is a concave shape in order to fit the round head screw.
Put an adaptor on the tip of the earth side lead of a L9787 Test Lead or L9788-11 Test Lead Set with Remote Switch

Replacing of Batteries and Fuses

WARNING

- To avoid electric shock, turn off the function switch and disconnect the test leads from the object to be measured, before replacing the batteries or fuse.
- To avoid electric shock, turn off the MEASURE key and disconnect the test leads before replacing the batteries or fuse.
- After replacing the batteries or fuse, place back the cover and tighten the screws before using the instrument.
- Do not mix old and new batteries, or different types of batteries. Also, be careful to observe battery polarity during installation. Otherwise, poor performance or damage from battery leakage could result.
- Battery may explode if mistreated. Do not short-circuit, recharge, disassemble or dispose of in fire.
- Handle and dispose of batteries in accordance with local regulations.
- Please use only the specified fuse. Specified fuse can be purchased, so contact your dealer or Hioki representative. Using a non-specified fuse or shorting the fuse holder may cause a life-threatening hazard.
Fuse type: FF0.5AH/ 1000 V (70 172 40.0.500: SIBA)
(Very fast acting, arc extinction type, high rupturing capacity type)
Fuse can be purchased from your Hioki distributor.

CAUTION

- To avoid corrosion from battery leakage, remove the batteries from the instrument if it is to be stored for a long time.
- Do not use manganese batteries, but alkaline or nickel-metal hydride batteries only.
- The instrument with nickel-metal hydride batteries inserted is not drop-proof.

- Turn the function switch to OFF and remove the test lead from the instrument as a precaution.
- Loosen the central fastening screw at the back of the instrument and remove the battery cover.
- Replace all 4 batteries or the fuse.
- Place back the battery cover and tighten the screw.

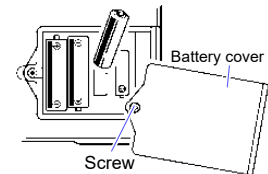

Measurement Procedures

Preparing for Measurement

- Attach the strap.
- Insert the batteries.
- Connect the test lead (connect the black test lead to the EARTH terminal, and the red test lead to the LINE terminal)

Attaching the strap

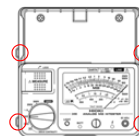

Pass the ring on both ends of the supplied strap through each of the four holes in the instrument.

Pre-measurement inspection

- Adjust the needle to point to zero before measuring. With the function switch at OFF, turn the meter movement zero adjuster with a screw driver until the needle points to the center part of the ∞ in the scale.
- Verifying the solid connection and integrity of the test leads
 - Turn the function switch to one of the Insulation Resistance Measurement functions.
 - Short circuit the tips of the test leads.
 - Push down the MEASURE key, and confirm that the needle is pointing to 0 MΩ.

- Confirming the battery power
Set the function switch away from OFF and confirm the effective battery range indicator. Battery power is high when a green light is shown. Battery power is low when a red light is shown and replacement is recommended. Battery is drained when no light is shown. Please replace the batteries then.

• Auto power save (power-saving function)

When the function switch is not at OFF, the power save function automatically kicks in 15 minutes after the last time the MEASURE key is pressed and the effective battery range indicator goes off. The automatic power save function cannot be cancelled.

Reviving from power save

Turn off the function switch then return to the original position.

• Insulation Resistance Measurement

⚠ WARNING

Observe the following to avoid electric shock, short circuits, and damage to the instrument.

- When measuring insulation resistance, dangerous voltage is applied to the measurement terminals. To avoid electric shock, do not touch the probe.
- Never touch the object being measured immediately after measuring. There is danger of electric shock from the charge accumulated during high voltage testing.
- Discharge the subject conductor after measurement.
- Do not attempt to measure insulation resistance on a live conductor. Doing so could damage the instrument or cause an accident that might result in injury or death. Always turn off power to the conductor being measured before starting.

⚠ CAUTION

- Insulation resistance is the ratio of leakage current to applied voltage, and is therefore unstable. Depending on the specific object being measured, the needle may not stabilize, but this is not a meter malfunction.
- Press the MEASURE key fully down until a click is heard. If the button is not pressed down fully, the needle will not move from ∞ and a proper measurement cannot be made.
- Always release the MEASURE key after use.

1. Use the function switch to select the measurement voltage.
2. Connect the black test lead to the ground side of the object being measured.
3. Connect the red test lead to the line to be measured.
4. Press the MEASURE key. (To make continuous measurements, pull the button up.)
5. Read the value after the needle has stabilized.

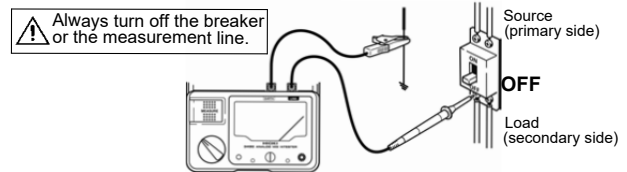

*When measuring an insulation resistance that contains a capacitance element, a charge proportional to the measurement voltage accumulates, and if undischarged could lead to an electric shock accident.

6. Without removing the test leads from the item being measured, release the MEASURE key.
7. The built-in discharge circuit automatically discharges the item. During a discharge, the needle will return slowly to the infinity (∞) position.
8. The discharge is completed when the needle reaches the ∞. The time required for discharge depends on the capacitance value.

• AC Voltage Measurement

⚠ DANGER

- Test leads should only be connected to the secondary side of a breaker, so the breaker can prevent an accident if a short circuit occurs. Connections should never be made to the primary side of a breaker, because unrestricted current flow could cause a serious accident if a short circuit occurs.
- Attempting to measure voltage in excess of the maximum input voltage and maximum rated voltage to earth could destroy the instrument and result in personal injury or death.
- To avoid electrical shock, be careful to avoid shorting live lines with the test leads.

⚠ WARNING

Never press the MEASURE key while measuring voltage. Doing so could damage the circuitry or cause a life-threatening accident

1. Use the function switch to ~V (ACV).
2. Connect the black test lead to the ground side of the object being measured.
3. Connect the red test lead to the line to be measured.
4. Read the value after the needle has stabilized.

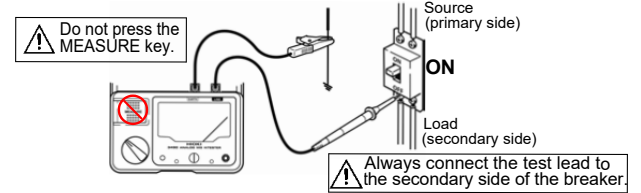

• Low Resistance Measurement

⚠ WARNING

Do not measure under a live circuit condition.

Before measuring, zero adjustment to cancel the test lead wiring resistance, etc. is necessary.

1. Turn the function switch to either 3 Ω or 30 Ω.
2. Short circuit the tip of the test lead.
3. Pull up the MEASURE key.
4. Turn the 0 Ω AJD knob and adjust the needle until it points to the center part of 0 Ω of the low resistance scale. (Adjust to 0 Ω, including the test lead line resistance for external resistance connected directly to the test object.) Push down the MEASURE key.
5. Connect the test lead to the ground side of the object being measured.
6. Press the MEASURE key and read the indicated value.
7. Turn off the MEASURE key after using.

• Example of measuring the earthing conductor resistance

⚠ CAUTION

If an additional operating circuit is connected in parallel to the circuit under measurement, the measurement error may occur due to the effects of impedance of the circuit connected in parallel or transient currents.

Measure the earthing conductor resistance at 3 Ω range. Please refer to the low resistance measurement for measuring method.

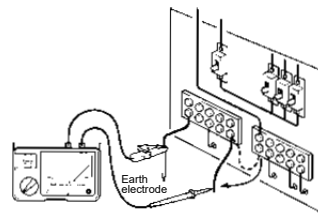

• Operation Uncertainty

The operation uncertainty and the variations of measurement value for the respective Influence quantity approved by EN61557 are as follows:

Intrinsic uncertainty/ Influence quantity	Operation range	Variation		
		Insulation Resistance	Low Resistance	
A	Intrinsic uncertainty	Reference condition	±2%	±3%
E ₁	Position	Horizontal ±90°	±4%	±4%
E ₂	Supply voltage	4.5 V to 6.8 V	±1%	±3%
E ₃	Temperature	0°C to 35°C	±1.5%	±3%
B	Operation uncertainty		±10%	±10%
Guaranteed range of operation uncertainty		1st effective measurement range	0~ effective maximum scale value	

Influencing factor non-applicable for E₄ to E₁₀

• Measurement principles

1. Insulation Resistance Measurement

The insulation resistance of test object Rx is obtained by supplying a voltage V to the test object and measuring the current leaking from the test object and the voltage supplied using the formula (Voltage supplied, V)/(current leakage, I).

2. AC Voltage Measurement

This is obtained from converting the value of the current flowing from the voltage source through the instrument to a voltage value.

3. Low Resistance Measurement

The resistance of test object Rx is obtained by supplying a specific current I to the test object and measuring the voltage occurring between the test terminals formula (inter-terminal voltage, V)/(supplied current I).