

GroundFlex[®] Adapter Model 6474



GROUND FLEX[®] ADAPTER

Measure Up
WITH AEMC[®] INSTRUMENTS



Copyright© Chauvin Arnoux®, Inc. d.b.a. AEMC® Instruments. All rights reserved.

No part of this documentation may be reproduced in any form or by any means (including electronic storage and retrieval or translation into any other language) without prior agreement and written consent from Chauvin Arnoux®, Inc., as governed by United States and International copyright laws.

This documentation is provided “as is,” without warranty of any kind, express, implied, or otherwise. Chauvin Arnoux®, Inc. has made every reasonable effort to ensure that this documentation is accurate; but does not warrant the accuracy or completeness of the text, graphics, or other information contained in this documentation. Chauvin Arnoux®, Inc. shall not be liable for any damages, special, indirect, incidental, or inconsequential; including (but not limited to) physical, emotional or monetary damages due to lost revenues or lost profits that may result from the use of this documentation, whether or not the user of the documentation has been advised of the possibility of such damages.

Statement of Compliance

Chauvin Arnoux®, Inc. d.b.a. AEMC® Instruments certifies that this instrument has been calibrated using standards and instruments traceable to international standards.

We guarantee that at the time of shipping your instrument has met its published specifications.

NIST traceable calibration is only possible when the Model 6474 is connected to the Ground Tester Model 6472. To obtain NIST calibration (for a nominal charge), the instrument would need to be returned to our facility along with your Ground Tester Model 6472.

The recommended calibration interval for this instrument is 12 months and begins on the date of receipt by the customer. For recalibration, please use our calibration services. Refer to our repair and

Serial #: _____

Catalog #: 2136.03

Model #: 6474

Please fill in the appropriate date as indicated:

Date Received: _____

Date Calibration Due: _____



TABLE OF CONTENTS







1. INTRODUCTION	5
1.1. PRECAUTIONS FOR USE	6
1.2. RECEIVING YOUR SHIPMENT	6
1.3. ORDERING INFORMATION.....	7
1.3.1. Accessories.....	7
1.3.2. Replacement Parts.....	7
2. GROUND FLEX® ADAPTER	8
2.1. CONTROL FEATURES	8
2.2. GROUND FLEX® SENSOR	9
2.2.1. Calibration of GroundFlex® Sensors.....	10
2.3. MEASUREMENTS IN AUTO MODE.....	12
2.3.1. Preparation of the GroundFlex® Adapter	12
2.3.2. Making a Measurement (Resistance of Legs).....	14
2.3.3. Other Measurements.....	16
2.4. MANUAL MODE AND SWEEP MODE	16
2.5. TOWER TESTING MEASUREMENT	18
2.5.1. Choosing the positions for the H, S electrodes:	18
3. SPECIFICATIONS	26
3.1. ELECTRICAL.....	26
3.2. MECHANICAL	28
3.3. ENVIRONMENTAL.....	28
3.4. SAFETY.....	28
4. MAINTENANCE	29
4.1. CLEANING	29
4.2. REPAIR AND CALIBRATION.....	29
4.3. TECHNICAL AND SALES ASSISTANCE	30
4.4. LIMITED WARRANTY	30
4.4.1. Warranty Repairs	31

1. INTRODUCTION

Thank you for purchasing an **AEMC® Instruments GroundFlex® Adapter Model 6474**.

For the best results from your instrument and for your safety, you must read the enclosed operating instructions carefully and comply with the precautions for use. Only qualified and trained operators should use this product.

Symbols & Definitions

	Signifies that the instrument is protected by double or reinforced insulation.
	CAUTION - Risk of Danger! Indicates a WARNING . Whenever this symbol is present, the operator must refer to the user manual before operation.
	Indicates a risk of electric shock. The voltage at the parts marked with this symbol may be dangerous.
	Ground/Earth
	Indicates Important information to acknowledge.
	In the European Union, this product is subject to a separate collection system for recycling electrical and electronic components in accordance with directive WEEE 2002/96/EC.

Definition of Measurement Categories

CAT IV corresponds to measurements performed at the primary electrical supply (< 1000 V).

Example: primary overcurrent protection devices, ripple control units, and meters.

CAT III corresponds to measurements performed in the building installation at the distribution level.

Example: hardwired equipment in fixed installation and circuit breakers.

CAT II corresponds to measurements performed on circuits directly connected to the electrical distribution system.

Example: measurements on household appliances and portable tools.

1.1. PRECAUTIONS FOR USE

These safety warnings are provided to ensure the safety of personnel. Please **read** and **comply** with these precautions:

- ◆ This instrument is protected from accidental voltages of not more than 50V with respect to earth in measurement CAT IV. The guaranteed level of protection of this equipment may be compromised if used in a manner not specified by the manufacturer.
- ◆ Safety is the responsibility of the operator.
- ◆ All metal objects or wires connected to the electrical system should be assumed to be lethal until tested. Grounding systems are no exception.
- ◆ Never exceed the maximum rated voltage and current, and the measurement category.
- ◆ Never exceed the protection limits, and always comply with the conditions and place of use, indicated in the specifications.
- ◆ Do not use the instrument or its accessories if they appear damaged.
- ◆ Use accessories that have overvoltage category and service voltages greater than or equal to those of the instrument (CAT IV 50V). Use only accessories that comply with safety standards (IEC 61010-2-031 & 32).
- ◆ Wear the appropriate protective gear (insulating boots and gloves).
- ◆ Check that no terminal is connected and the switch is set to OFF before opening the device.
- ◆ Use only the charging unit supplied with the instrument to recharge the battery.
- ◆ Troubleshooting and metrological verification procedures must only be performed by qualified, approved personnel, or the factory.
- ◆ **NOTE:** The potentials on the various rods used for an earth measurement may be different if a nearby electrical installation is defective or certain weather conditions prevail (thunderstorms). It is up to the operator to decide whether to continue or postpone measurements in these situations.

1.2. RECEIVING YOUR SHIPMENT

Upon receiving your shipment, make sure that the contents are consistent with the packing list. Notify your distributor of any missing items. If the equipment appears to be damaged, file a claim immediately with the carrier and notify your distributor at once, giving a detailed description of any damage. Save the damaged packing container to substantiate your claim.

1.3. ORDERING INFORMATION



NOTE: The GroundFlex® Adapter Model 6474 only operates in combination with the Ground Tester Model 6472 Kit - 500 ft.

GroundFlex® Field Kit (Model 6472 and 6474) Cat. #2136.03

Includes: (Ground Tester Model 6472 Kit-500 ft (Cat #2135.54)); Model 6472, (1) carrying bag, (2) 500 ft. color-coded leads on spools (red/blue), (2) 100 ft. color-coded leads (hand tied, green/black), (1) 30 ft. lead (green), (2) 5 ft. color-coded leads (red/blue), 100/240 V power adapter with US power cord, optical USB cable, (4) T-shaped auxiliary ground electrodes, set of (5) spaded lugs, (1) 100 ft. tape measure, rechargeable NiMH battery pack, USB stick with DataView® software, ground tester workbook and user manual. GroundFlex® Adapter Model 6474, (4) GroundFlex® sensors (5 m), (12) color-coded rings, connection lead, (2) extension leads on H reel (black/green) with color-coded alligator clips, (1) extra green and black alligator clips, (2) BNC extension leads, calibration loop, (3) C-clamps, set of (2) reel caddy's, (1) inverter 12 VDC to 120 VAC watt (vehicle use), carrying case with wheels and handle for meters and user manual.

1.3.1. Accessories

Bag #6 - Carrying Bag for Ground Kits.....	Cat. #2119.82
Tape Measure - AEMC® Instruments (100 ft).....	Cat. #2130.60
Set of two, 14.5 in T-shaped Auxiliary Ground Electrodes	Cat. #2135.39
Optical USB Cable	Cat. #2135.41

1.3.2. Replacement Parts

Connection Lead for Model 6472/6474.....	Cat. #2135.75
One BNC (15 m/50 ft) Extension Lead.....	Cat. #2135.76
Set of 12, GroundFlex® Rings (red, yellow, brown, orange).....	Cat. #2135.77
Green Extension Lead	Cat. #2135.78
Black Extension Lead	Cat. #2135.79
Set of 3, C-clamps	Cat. #2135.80
Calibration Loop.....	Cat. #2135.82
Carrying Case	Cat. #2135.83
One GroundFlex® (5 m/16 ft) Sensor.....	Cat. #2135.92
Safety Alligator Clip (black).....	Cat. #5000.99
Safety Alligator Clip (green)	Cat. #5100.06
GroundFlex® Sensor 10 m	Cat. #2135.87

Order Accessories and Replacement Parts Directly Online
Check our Storefront at www.aemc.com/store for availability

2. GROUND FLEX® ADAPTER

2.1. CONTROL FEATURES

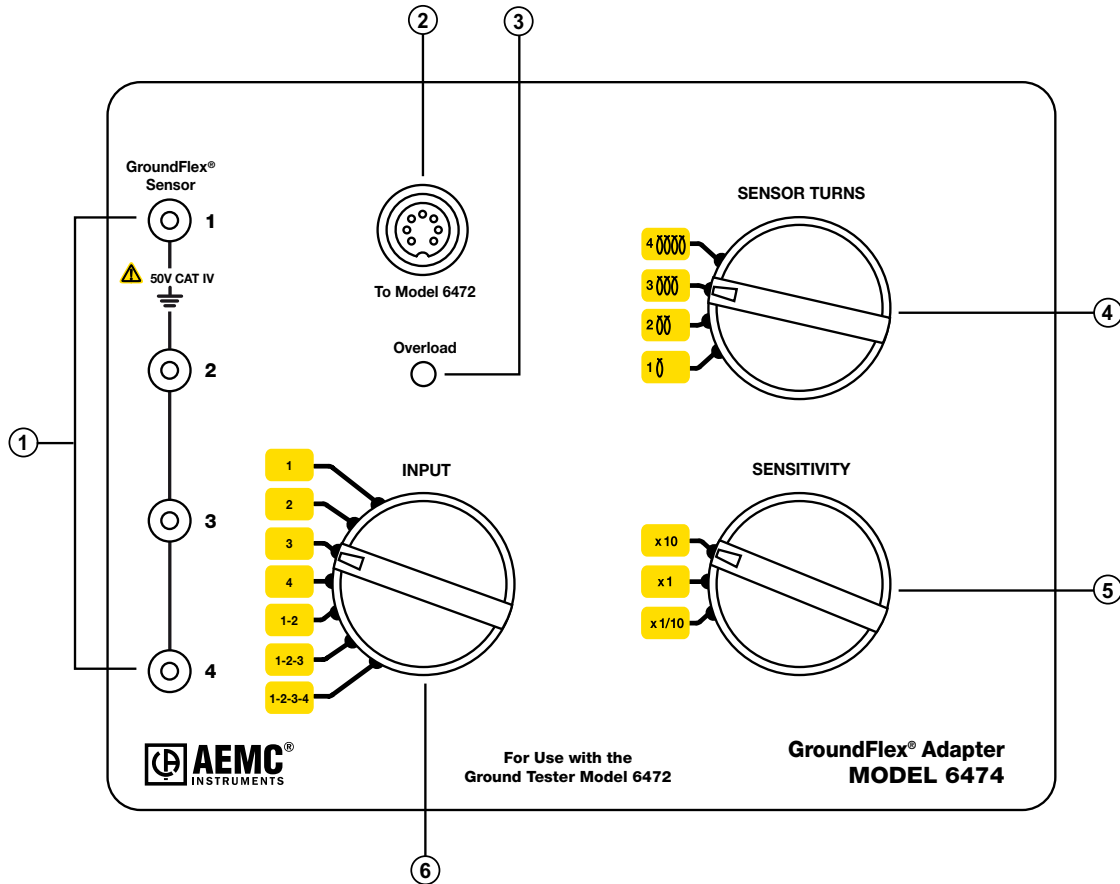

1. Inputs 1 through 4 for GroundFlex® sensors
2. Connector for connection lead to the Ground Tester Model 6472
3. OVERLOAD indicator
4. SENSOR TURNS selector: 1, 2, 3 or 4
5. SENSITIVITY selector: x10, x1 or x1/10
6. INPUT SELECTION: 1, 2, 3, 4, 1-2, 1-3 or 1-4

2.2. GROUND FLEX® SENSOR

The GroundFlex® sensors are placed around a conductor (tower leg or pole) and closed using a screw connector, which is part of the sensor. This closed loop is then used to make a contact-free measurement of the current flowing in the conductor (leg) it is wrapped around.

These sensors are current measurement clamps but are able to enclose objects that are much larger.

GroundFlex® sensors are available in lengths of up to approx 24 ft (8 m) and can be placed around objects (such as tower legs) up to in approx 8ft diameter (2.7 m).

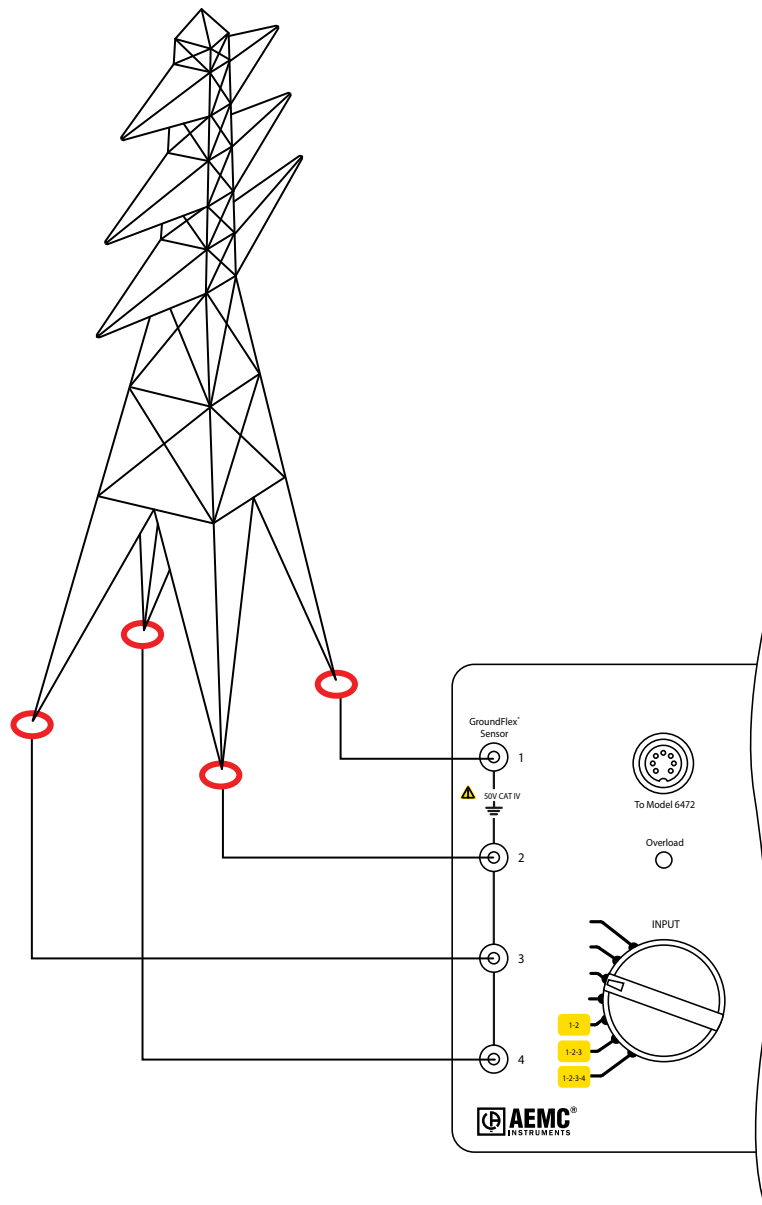

2.2.1. Calibration of GroundFlex® Sensors

Calibration is necessary for a new sensor, one that is no longer identified when a sensor has been replaced, or more than 2 lengths of extension cable is used. The calibration coefficients are then stored in the Model 6474.



WARNING: Do not move or touch the GroundFlex® sensor or the calibration loop during the calibration. This could cause errors.

Start by identifying each sensor using the identification rings that are supplied with the Model 6474: (1) Brown (2) Red (3) Orange (4) Yellow

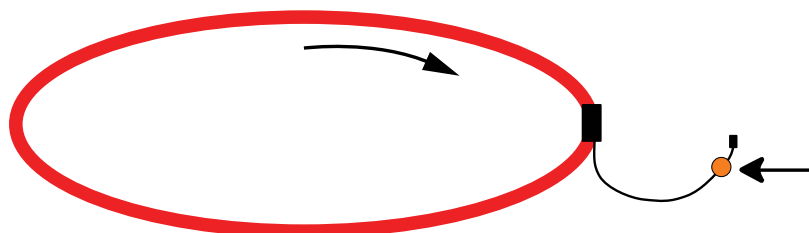

- Connect the calibration loop between terminals H and E of the Model 6472.
- Connect the Model 6472 and 6474 together using the connection cable.
- Connect the GroundFlex® sensor with the Brown ring to Input 1 of the Model 6474, the one with the Red ring to Input 2, the one with the Orange ring to Input 3, and the one with the Yellow ring to Input 4.
- Coil the GroundFlex® sensor four times around in the calibration loop and close it using its screw connector. Place the connector as far as possible from the calibration device.

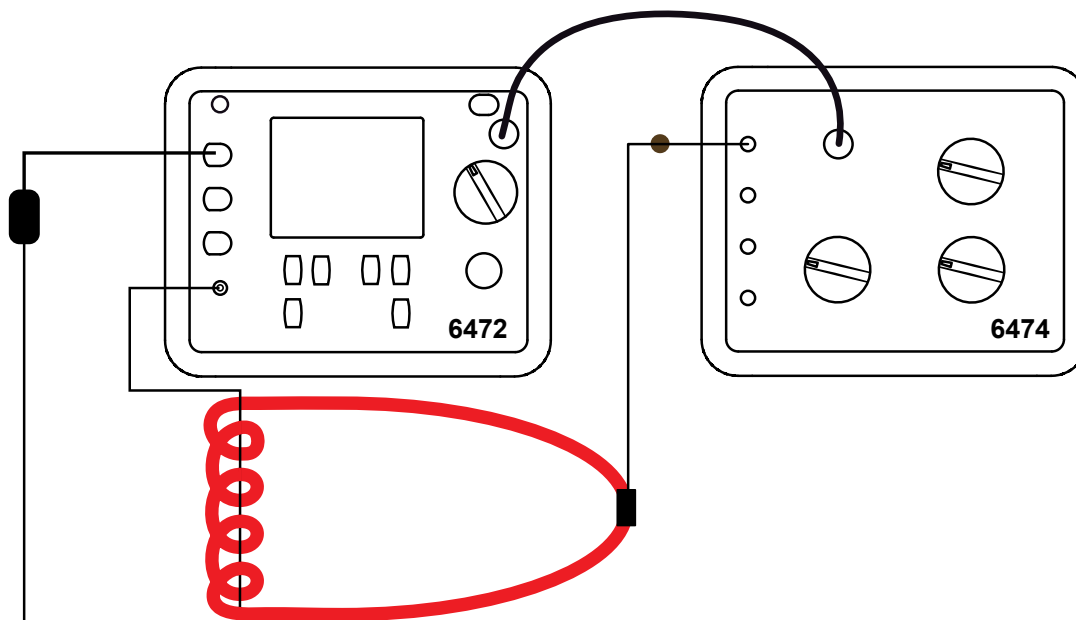

1. Set the switch of the 6472 to **SET-UP**.
2. Set the **SENSOR TURNS** switch to 4.
3. Set the **SENSITIVITY** switch to x1.
4. Set the **INPUT SELECTION** switch to 1.

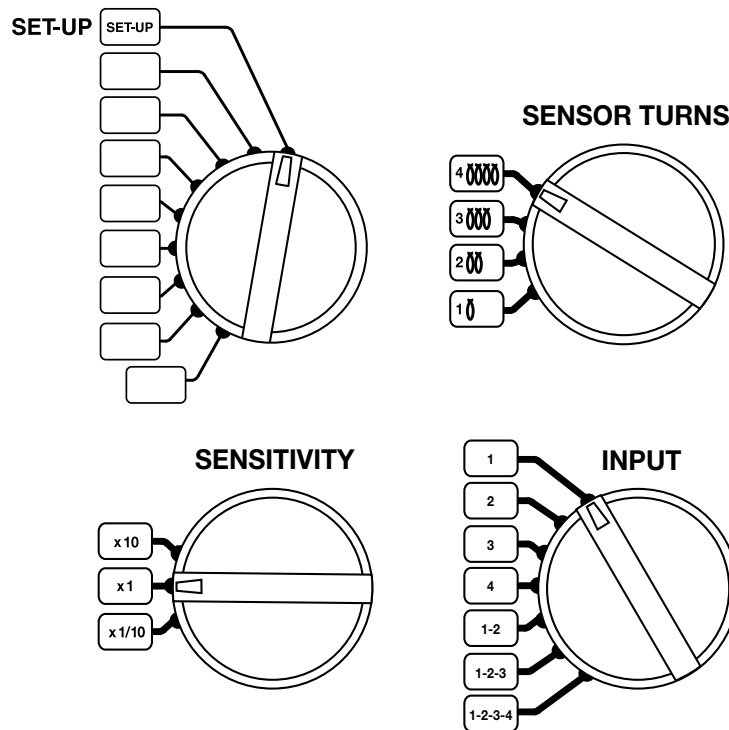

5. Press the **Hz/OPTIONS** button 5 times.

The device starts by comparing the current I_{int} injected by the device into the calibration loop to the current I_A measured by the GroundFlex[®] sensor. If they are different, the "CAL" symbol blinks to recommend a calibration.

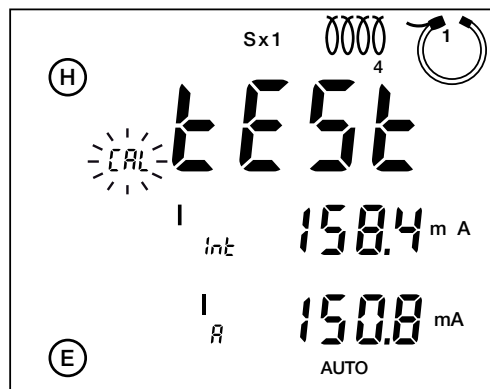
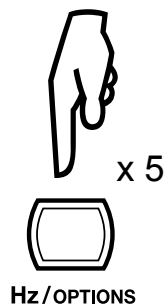

NOTE: To avoid measurement errors, do not touch the GroundFlex[®] sensor or the calibration loop during the calibration.

6. To start the calibration, press **2nd + START**.
7. The device calculates and stores a calibration coefficient for the GroundFlex® sensor connected to channel 1.

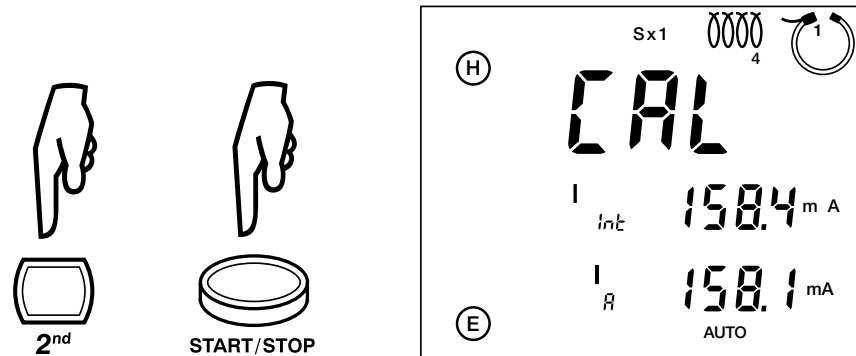

This operation must be repeated for channels 2, 3 and 4; the **INPUT SELECTION** switch must be set to the corresponding position each time.

The calibration values are now stored into memory.

After calibration, the GroundFlex® sensors must always be connected to their respective channels.



NOTE: Always connect the same sensor to the same input..

2.3. MEASUREMENTS IN AUTO MODE

2.3.1. Preparation of the GroundFlex® Adapter

The GroundFlex® Adapter Model 6474 is designed to be used only with the Model 6472 device. The two instruments must be connected using the special connection cable supplied. The Model 6474 has no ON/OFF button, and is powered only by the Model 6472, via this connection cable.

The Model 6474 is intended primarily to measure the current that flows through a high-voltage tower to the ground. You can wrap up to 4 legs of the towers each with a GroundFlex® sensor and measure the current flowing to earth through each of the legs or through several legs.

1. Set the rotary function switch to GroundFlex® on the Model 6472.
When you connect the GroundFlex® Adapter Model 6474 to the 6472, a self-test will begin. During this test, the **OVERLOAD** check light on the 6474 is lit.
2. Connect the required number of sensors to channels 1, 2, 3, and/or 4.

NOTE:

- The sensors have arrows to indicate a direction.
 - All sensors should face the same direction (clockwise or counter-clockwise around the tower legs)
 - All sensors should have the same number of wraps.
 - Sensors should encircle both leg AND ground system.
-

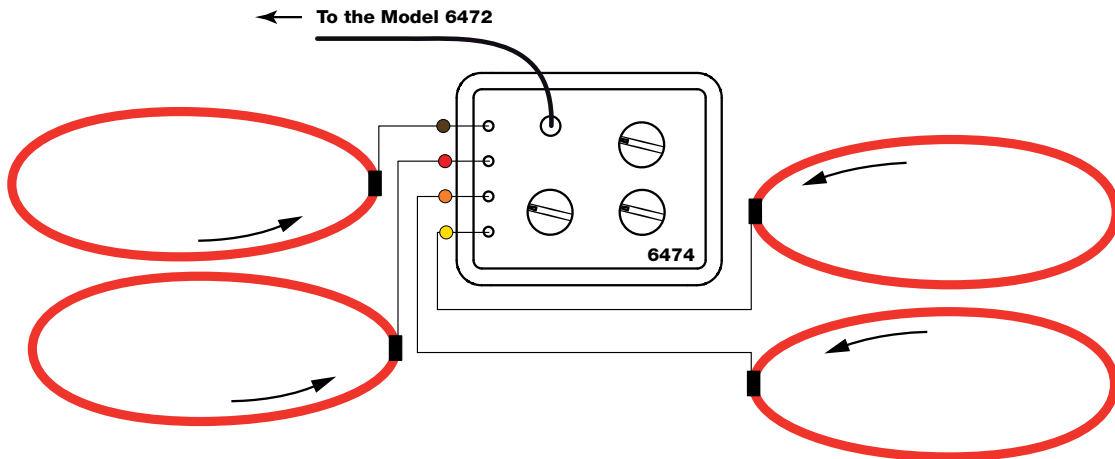

3. On the Model 6474, set the **INPUT** selection switch accordingly. You can measure the current flowing through one GroundFlex® sensor (1, 2, 3, or 4), or through several sensors (1, 2 or 1, 2, 3), or through all of the sensors (1, 2, 3, 4).
4. Select how many times the sensor is wrapped around the conductor to be measured (from 1 to 4 turns) using the **SENSOR TURNS** selection switch.



NOTE: To increase measurement sensitivity, we recommend when possible, wrapping a maximum number of turns (up to 4) around the structure.

5. Set the **SENSITIVITY** switch to the desired sensitivity: x1/10, x1, or x10. The choice of sensitivity depends on the expected current value. As a precaution, always start with the lowest sensitivity, x1/10, and increase it as needed.

2.3.2. Making a Measurement (Resistance of Legs)

1. Place auxiliary electrodes H (Z) and S (Y) on opposite sides of the tower, as far away as possible (100-150 ft) and, if possible, perpendicular to the high-voltage line (depth is not important). This will eliminate interference with the measurement by stray voltages or currents induced under the high-voltage line.



NOTE: The **H (Z)** and **S (Y)** electrodes can be placed in the same direction if necessary. In this case, the **S (Y)** electrode should be placed at 62% the distance of **H (Z)**.

2. In order to avoid electromagnetic interference, it is best to unwind the full length of each cable from the reel, to keep the cables as far apart as possible on the ground, taking care not to form loops, and to avoid placing the cables near or parallel to metallic conductors (cables, rails, fences, etc.). Effects of interference are measured in milli-ohms.
3. Connect these auxiliary electrodes to the terminals **H (Z)** and **S (Y)** on the Model 6472's front panel.
4. Important: The terminals **ES (Xv)** and **E (X)** must be connected to a conducting metallic part of the tower located above the GroundFlex® sensors. This ensures measurement of the current flowing downward and towards the earth (otherwise, you would measure the current flowing upward, from the earth to the top of the tower).
This will tell the condition of the overhead ground conductor.
5. Connect the required number of GroundFlex® sensors to channels 1, 2, 3, and/or 4 (the channels for which they are calibrated) and place the GroundFlex® sensors around the legs of the tower.



NOTE: The direction of coiling of the sensors around tower legs have no effect on the measurement, but **all** of the GroundFlex® sensors must be coiled in the **same direction** and have the same orientation (check arrow direction on the sensor) and they must **all** have the **same number of turns**. Sensors should encircle both leg **AND** ground system.

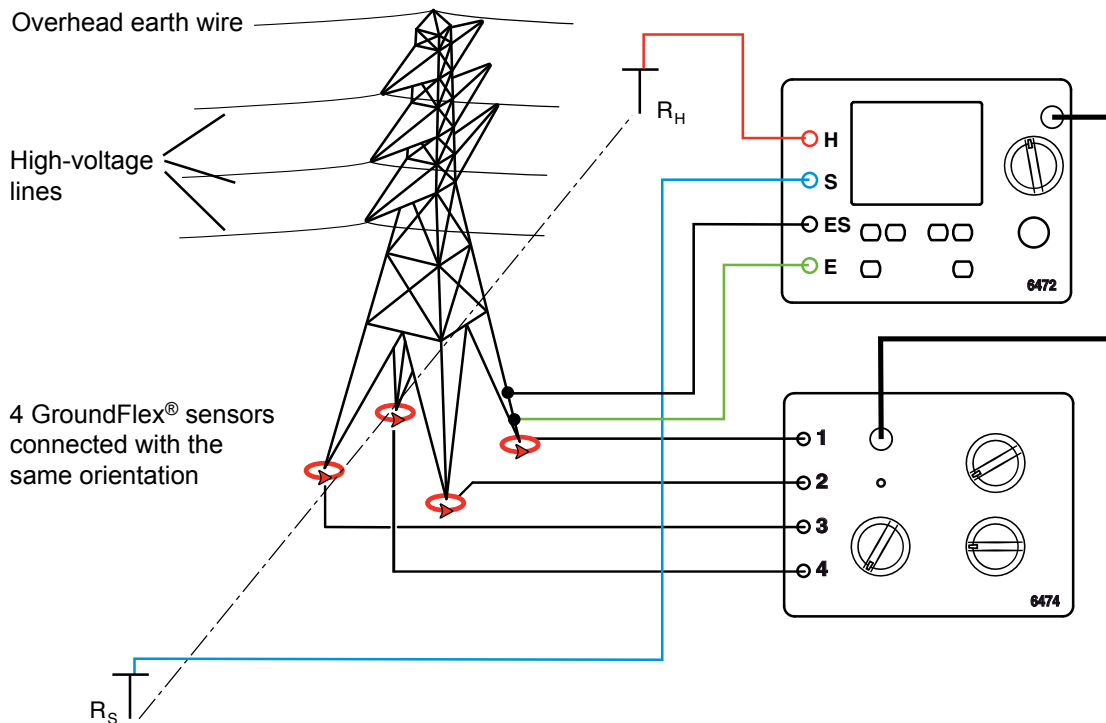

WARNING: If the GroundFlex® Adapter Model 6474 is connected to the earth tester, the earth potential connected to the terminals **E (X)** and **ES (Xv)** will also be present at the BNC connectors of the GroundFlex® sensors and at the connecting cable between the adapter and tester. Whenever any doubt exists about this earth potential, the user should proceed to a voltage measurement using the **S (Y)** and **ES (Xv)** terminals of the tester.

1. Set the 3 switches (Inputs, Turns and Sensitivity) of the GroundFlex® Adapter according to the connection made.
2. Start the measurement by pressing the **START/STOP** button.

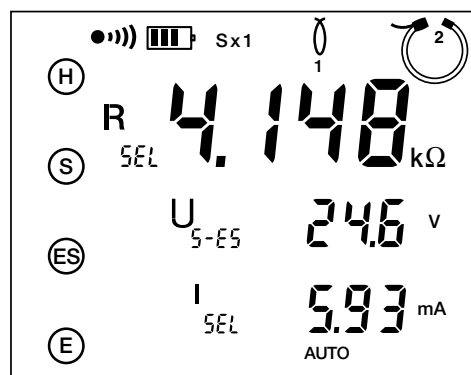
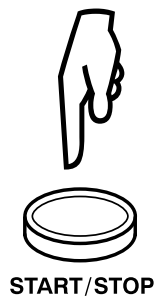

To display the measurement parameters, press **DISPLAY** several times.

The device displays the following parameters:

R_{SEL} , U_{S-ES} and its frequency, I_{SEL} , R-Act (R_{PASS}), U-Act (U_{S-ES} and its frequency, U_{H-E} and its frequency), I-Act (I_{SEL} and its frequency).

To measure the resistances of electrodes **H (Z)** and **S (Y)**, or if the resistance of the electrodes is too high, start the measurement by a long press (approx 2 sec) of the **START/STOP** button (you will hear a 2nd beep).

R_H , R_S , U_{H-E} , I_{H-E} will be displayed.

2.3.3. Other Measurements

As explained in Step 4 on the previous page, terminals **ES (Xv)** and **E (X)** must be connected to a metallic part of the tower above the GroundFlex® sensor in order to measure the current flowing ISEL downward through the sensor towards the earth to measure ground resistance of the leg.

If connections **ES (Xv)** and **E (X)** are placed below the GroundFlex® sensor, the latter measures the current flowing towards the top of the tower via the overhead ground conductor at its top, and you can in this way evaluate the quality of this overhead ground conductor.

You can even make this measurement without moving the contacts of **ES (Xv)** and **E (X)** on the tower by simply passing the 2 connecting cables through the GroundFlex® sensor. The current in connecting cable **E (X)** and the current through the leg of the tower then cancel each other out.

You can also measure any leakage currents (I-Act) flowing through each leg of the tower in normal operation of the high-voltage line. If you find different leakage currents in each leg, but they cancel out when added together, you can conclude that these currents, induced by the rotating field of the high-voltage lines, indicate an earthing fault of the tower via the overhead ground wire at the tip of the mast.

2.4. MANUAL MODE AND SWEEP MODE

Use the **Hz/OPTIONS** button and ► button to change to **MANUAL** mode. The following parameters can be modified:

- 128Hz blinks → Change the test frequency
- Test voltage blinks → Switch between 10, 16, 32 and 60V

You can also perform a frequency sweep and a smoothing.

In the sweep mode, the measurements can be made at frequencies up to 5kHz. On a single tower, frequencies in the order of 5kHz do not always entail inductive effects, but the "current loops" formed by the adjacent towers and the return channel through the ground may result in inductances that can be detected only at high frequencies.

An equivalent diagram of the components forming this circuit is as follows:

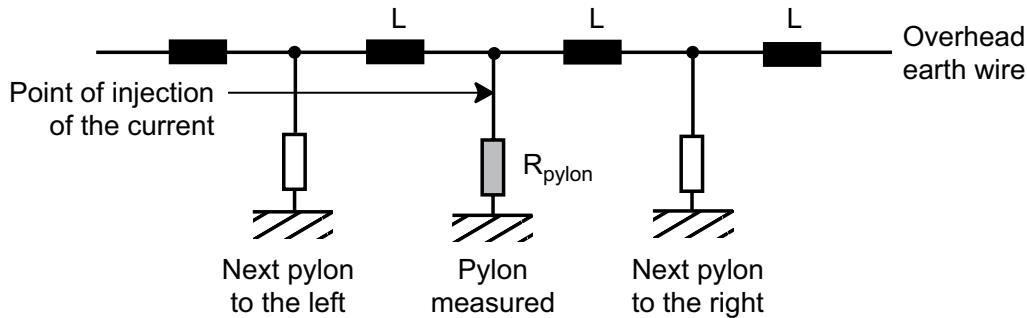

A measurement in sweep mode (SWEEP) of an installation like this having 10 towers gives the following results assuming an earth resistance R_{pylon} of 10Ω for each tower and an inductance L of $550\mu H$ for the link via the overhead ground conductor at the tip of the towers:

Impedance of the towers

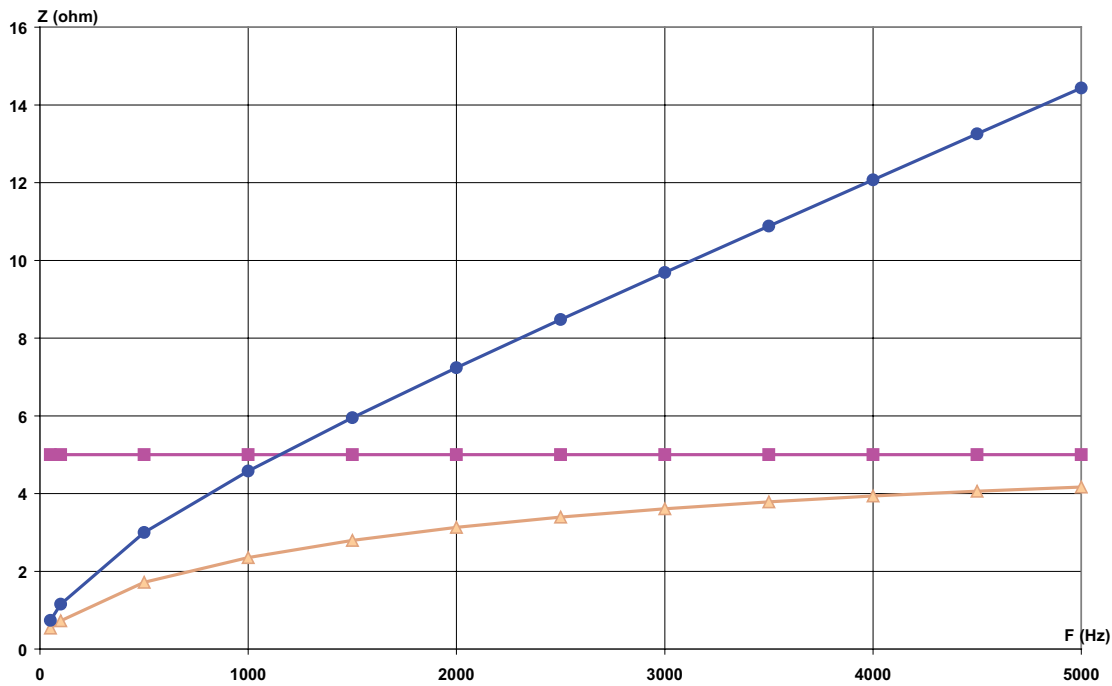

- Measurement of a tower earth impedance with GroundFlex® sensors
- ▲ Conventional 4 pole measurement
- Measurement into the top of a tower (iterative network impedance)

2.5. TOWER TESTING MEASUREMENT

1. Connect the green Current (E) and black Voltage (ES) test leads to the grounding system to be tested using separate cables. Connection points should be side by side and above the GroundFlex® (Rogowski) coil when testing tower leg resistance and/or impedance.

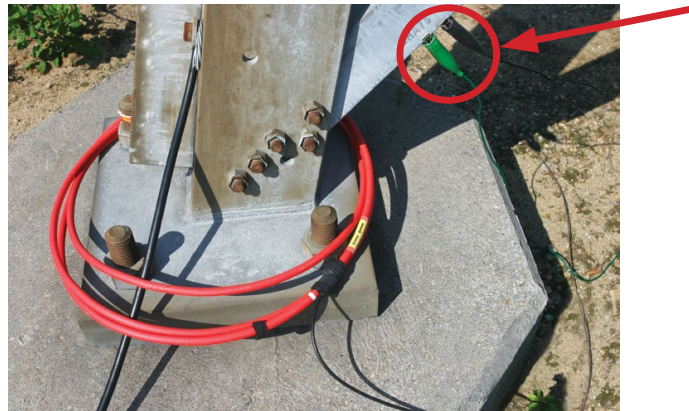

Figure 1

2. Wrap the GroundFlex® coils around the tower's leg(s). By increasing the number of turns around the tower's leg(s), the resulting measurements will be more robust. All coils must have the same number of turns around each tower leg.
3. Install all coils in the same rotational direction, either clockwise or counterclockwise. The coax cables on the GroundFlex® sensors have arrows to indicate the rotational direction that must be consistent between tower legs. On towers with 3 or 4 legs, the sensors must be in sequence from one leg to the next.

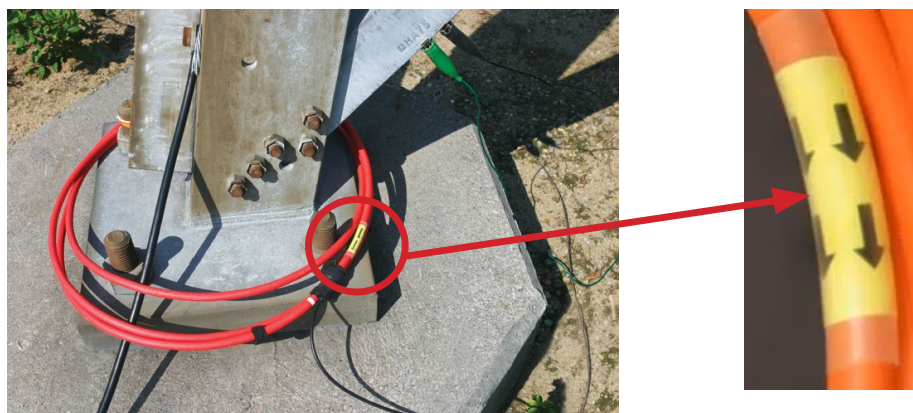

Figure 2

2.5.1. Choosing the positions for the H, S electrodes:

1. If possible, position the H and S electrodes 90° to the High Voltage (HV) line, and place one to the left and the other to the right with respect to the HV transmission line. If this is not possible, stay at least 30° off parallel to the HV line. The minimum distance should be 150 – 300 ft (50-100m). Never place an electrode within the minimum distance from the HV line and/or parallel to the HV line.
2. Connect the H electrode using the red (H) lead and the S electrode using the blue (S) lead (see Figure 2).



NOTE: The resistance for the **H** and **S** electrodes to earth should each be below 1 k Ω to ensure good test results.



Figure 3

3. For the most accurate measurements, roll the cable completely out to eliminate any inductance problems in locations with high overhead energy from the HV line. Normally errors are in the milliohm region when the cables are not fully removed from the spool.
4. Confirm that the umbilical cable connection between the 6472 and 6474 is secure. Check the position of the rotary switches (Input, Sensor Turns and Sensitivity) on the 6474 to be sure they match the test requirements (see Figure 4).
5. Make sure the number of turns between tower legs are the same. The number of turns must correspond to the number of turns used on the installed GroundFlex[®] coils on each tower leg.

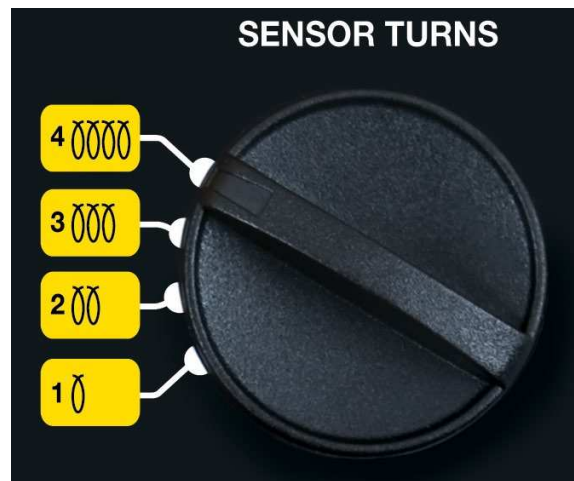

Figure 4

6. Use input switch position "1-2-3-4" for measurement of the total pylon earth current on four leg towers. Use the corresponding switch position for 2 (1-2) and 3 (1-2-3) leg towers.
7. Start the test with x10 amplification.
8. Turn the rotary switch on the model 6472 to the GroundFlex[®] position. The 6474 amplifier will turn on after the 6472 is powered on and the calibration of the connected GroundFlex[®] sensors will be verified. The Overload LED will come on for a few seconds during power up. If this LED is flashing continuously and the 6472 is beeping continually, then the current in the GroundFlex[®] sensor(s) are too high for the selected amplification. Reduce to X1 and then to X1/10 if necessary. If it is still present in the 1/10 position, then reduce the number of turns of the GroundFlex[®] sensors.

First check (see Figures 5, 6, 7, and 8):



Figure 5



Figure 6

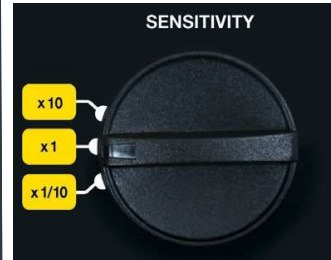

1. Press the DISPLAY button until U-Act. and US-ES or UH-E is shown. U-Act. refers to live actual voltage. U S-ES equals measured voltage between S and ES. Disturbance voltage measurements on the S Probe and the H Auxiliary electrode will run continuously as long as a test has not been initiated with the START button.
2. Press the DISPLAY key again until U-Act. and UH-E is shown. UH-E equals the measured voltage between H and E. The frequency of US-ES or UH-E appears when the corresponding voltage is higher than 0.1V. The measured voltage is caused by the current flowing through the tower into the Earth.
3. Check if the values for UH-E and US-ES are equal. When UH-E equals US-ES, the electrodes are placed far enough from the potential influence of the tower legs.
4. If one of the values is smaller than the other value, you should reposition the electrode that shows the smaller voltage further away from the HV-line and check US-ES and UH-E again.
5. Press the START-button when both measurements are equal to each other for a reliable active measurement. When both US-ES and UH-E are close to zero, then the HV-line is not in service or the overhead ground conductor is completely corroded or disconnected. In this case, the total pylon current will be also nearly zero.
6. Press the DISPLAY button until ISEL appears. This is the total pylon earth current and is measured by the 4 GroundFlex® sensors (channels 1-2-3-4 selected for a 4 leg tower).

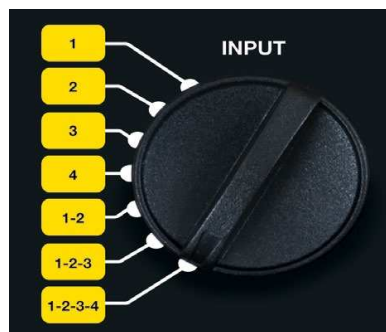

Figure 7 (model 6472)

- Next, press the DISPLAY button until RPASS appears. A leakage current I-SEL, when induced in the pylon, produces a voltage drop US-ES (potential difference to Earth) on the earth-resistance of the pylon. Once the I-SEL and US-ES values are known, the 6472 can calculate RPASS (passive earth resistance). It has the advantage of being measured at the nominal frequency of the network but is also influenced by the load fluctuations in the network and by the potential influence of the HV-line. When the tower earth resistance is actively measured and is nearly equal to RPASS, the result will be reliable; otherwise, the potential relationship during the active and passive measurement will be different.

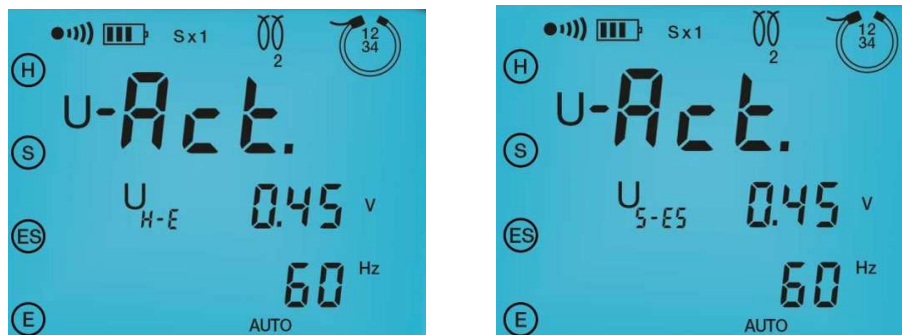

Figure 8 (model 6472)

Second check (See Figures 9):

- Currents in the tower legs are measured continuously as long as the START-button has not been pressed. Switch the model 6474 to INPUT 1. Select ISEL on 6472 with DISPLAY button.



Figure 9

- Check the current in each tower leg by switching through each channel in sequence while noting the measurements of each. You can find corroded and/or disconnected earth connections as indicated by readings that show no current flow.
- Check the sum of all leg current channels. If the total is approximately equal to the sum of the all individual leg currents, then the static wire (overhead ground conductor) is bonded to the tower properly. If not, this connection is probably corroded and only a small current will be flowing in the tower legs, which will be induced in the tower grounding. The sum will be very low, but, despite that, single currents may be higher because they can flow in different directions. The measurement of RPASS for individual legs has no value. Even when individual legs are not connected together. Below ground level, they will still influence each other.

Third check (See Figure 10):

1. Start a measurement with a long press on the 6472 START button in the 4-pole switch position. This will initiate the test using 32 Volts and will provide the full complement of test results including auxiliary rod (H and S) resistance. The measurement will be conducted at 128 Hz. When a measurement is initiated with a long press on the START button (by holding down for approximately 2 seconds until a second beep is heard), you will then get additional results including the resistances of electrodes RH and RS. Both should be below 1 K Ω if you want to perform a quality SWEEP test up to 5 kHz.
2. If RH or RS is higher than 1 k Ω , you can place more electrodes in parallel with each of them or you can moisten the soil in the area where the electrodes are placed. Parallel electrodes shall be placed at a distance of approximately 4x the depth of the H and S electrodes. RH should be as low as possible, because it determines the test current. The measurement precision is better when the test current is higher. Much of this current will flow through the overhead ground conductor, and only a small percentage will flow through tower legs into the earth. Test currents below 3mA can cause unreliable results, which are indicated by the flashing greater-than (>) and less-than (<) symbols to the left of the reading. When any input symbol is blinking on the display, it means that the corresponding lead is disconnected or broken. The measurement can be performed only if all connections are good.



Figure 10

Measurements:

When all parameters are in the "green zone" (proper range), 3 typical measurements on the tower can be accomplished.

1st measurement (See Figure 11):

GroundFlex® sensors measurement into the Earth

1. Perform a long press of the START button.
2. Make sure the device is in SWEEP mode.
3. Make sure the current injection and voltage measurement points (green and black leads) are above the GroundFlex® sensor.



Figure 11

2nd measurement (See Figure 12):

GroundFlex® sensor measurement into static wire (overhead ground conductor)

1. Make sure the device is in SWEEP Mode.
2. Move the current injection wire E (green) so it feeds through the GroundFlex® sensors on the tower leg and connects next to the potential connection.
3. Do not move the ES (black) potential connection.

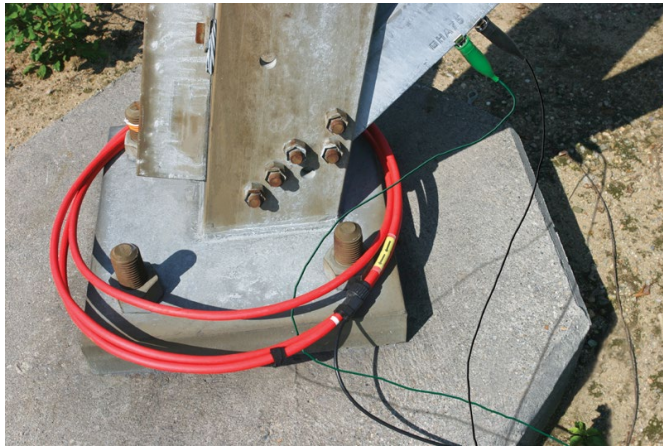

Figure 12



NOTE: In **SWEEP** mode a long press is automatically initiated and the measurements at each frequency used in the sweep are stored in memory.

Third measurement (See Figure 13):

4-pole Earth-impedance measurement (lattice network measurement)

1. Turn the 6472 to the 4-pole setting and make sure the device is in SWEEP Mode.
2. 4-pole Earth-impedance measurement (sometimes called "lattice network" measurement).
3. In this case, the total earth impedance of all components of the grounding system as if it is one resistance/impedance will be measured.

4. The overhead ground conductor (OGC) connects the grounding systems of all towers in parallel at low frequencies, but at higher frequencies the inductance of the OGC starts to separate them such that the effective impedance of an individual tower can effectively be measured.
5. Measure the resistance/impedance in 10 % increments between E and H.
6. Look for the plateau readings (usually between 50 % and 70 % distances to find the effective resistance/impedance of the structure under test.

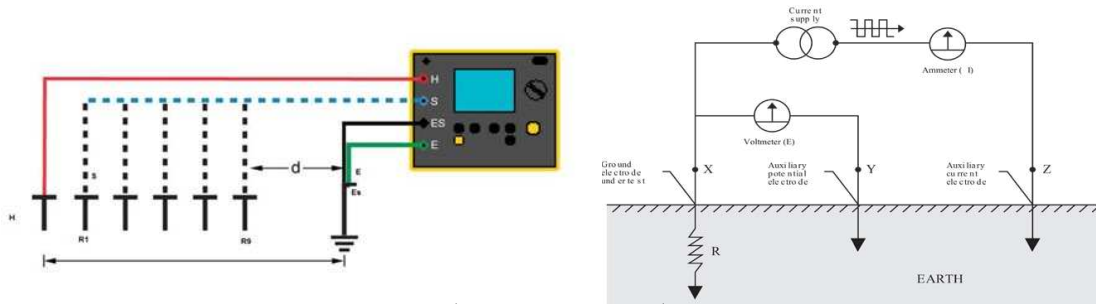

Figure 13

First check

1. Measure disturbance voltages UACT, US-ES, and UH-E. When US-ES and UH-E are close in value to each other, then the H and S electrodes are far enough away from the HV line. If they are different, move the electrode with the lower voltage further away from the HV line and recheck. When US-ES and UH-E are close to or equal to zero, the OGC is either badly corroded or disconnected.
2. Next, check RPASS and note it for later use.

Second check

1. Check the current in each tower leg (IACT/ISEL) to find corroded or disconnected grounding points. (break)If the sum of all legs is approximately the same as the sum of all individual legs, then the OGC is intact.

Third check

1. Press the START button with a long press to begin active measurements. Note the resistance of RH and RS.
2. If either or both are above 1 k Ω , add more electrodes or moisten the soil around them to lower their resistance to Earth.
3. 1st Measurement: use SWEEP mode with the black and green wires connected to the tower leg above the GroundFlex[®] sensor
4. 2nd Measurement: use the SWEEP mode with the black wire connected to the tower leg above the GroundFlex[®] sensor and the green wire connected to the tower leg next to the black lead and passing through the GroundFlex[®] sensor.
5. 3rd Measurement: use the SWEEP mode to perform a 4-pole impedance measurement.

Glossary

E Terminal: is a green colored terminal and is the current injector terminal. It is also known as the X terminal

ES Terminal: is a black colored terminal and is the voltage measurement terminal. It is also known as the Xv terminal.

S Terminal: is a blue colored terminal and is the voltage return terminal. It is also known as the Y terminal.

H Terminal: is a red colored terminal and is the current return terminal. It is also known as the Z terminal.

HV Line: is the power line running from tower to tower.

Top Line: is the overhead ground conductor also known as the sky wire in some areas.

UACT: is the real-time voltage measured before running a test

ISEL: is the total real-time leakage current measured

RPASS: is the passive earth resistance measured at normal network frequency.

SWEEP Mode: is a measurement mode where the 6472 takes measurements at 14 user selected frequencies between 40 and 5078 Hz.

4-Pole: refers to the number of terminals on the 6472 used in performing a test.

Green Zone: refers to all conditions being within range to properly take measurements

GroundFlex® Sensor: also known as AmpFlex Sensor or Rogowski coil which is a flexible device used to measure AC current flow.

U: used as the international symbol for Volts.

US-ES: Voltage measured at the potential terminals.

UH-E: Voltage measured at the injection terminals

RH: Resistance of the injector electrode

RS: Resistance of the potential electrode

OGC: used as a term to indicate the overhead ground conductor also called static wire or sky wire

Green Zone Conditions:

RH and RS: Resistance of each should be less than 1 k Ω if either or both are above that add more auxiliary electrodes in parallel or moisten the area around the electrode.

I-ACT: This measurement should be a minimum of 3 milliAmps

US-ES and UH-E: The voltage measurements for these should be close to each other. If they are not within a few volts of each other, move the auxiliary rod with the lower value further from the HV line and retest.

3. SPECIFICATIONS

3.1. ELECTRICAL

Measuring Method:

Voltage/Current measurement with a rectangular AC signal

Short Circuit Current: > 200 mAAC

Noise Suppression: > 80 dB at frequencies differing by 20 % or more from the test frequency

Max. Overload: 250 Vrms

Max. Value for R_H & R_S : 100 k Ω

Measuring Time: **Short push on START:** approx. 7 s for first value of R_E at 128 Hz, then 3 measurements per s.

Long push on START: approx. 15 s for first value of R_E at 128 Hz, then 3 measurements per s.

Pylon Measurement with GroundFlex®

Measurement Range	0.067 to 9.999 Ω	10.00 to 99.99 Ω	100.0 to 999.9 Ω	1.000 to 9.999 k Ω	10.00 to 99.99 k Ω
Resolution	0.001 Ω	0.01 Ω	0.1 Ω	1 Ω	10 Ω
Test Voltage	16 or 32 V user selectable (10, 16, 32, or 60 V for meters manufactured after August 2019) square wave (if current > 240 mA the output voltage is reduced to 10 V)				
Frequency	From 41 to 128 Hz selectable				
Resistance Measurement Frequency	From 41 to 5078 Hz selectable				
Accuracy	± 5 % of Reading + 1 ct @ 128 Hz				

The intrinsic error specified refers to reference conditions with a test voltage of 32 V, test frequency of 128 Hz, R_H , and $R_S = 1$ k Ω , no external voltage.

The operating error for measurements of R_H , R_S and R_E is the same as that specified for 4-Pole earth resistance measurement.

The operating error of AC resistance measurements can be less than that specified for voltage or current because frequency characteristics of the voltage channel are matched to those of the current channel.

For test frequencies between 41 and 5087 Hz, between 1 and 4 turns of the GroundFlex® sensor, and a selection of 1 to 4 measurement channels, the operating accuracies are the following:

SENSITIVITY and minimum I_{SEL} minimal		Operating accuracy for R_{S-ES}
S x 1/10	$I_{SEL} > 10 \text{ mA}$	$\pm (10 \% + 4 \text{ c ts})$
S x 1	$I_{SEL} > 5 \text{ mA}$	$\pm (5 \% + 4 \text{ cts})$
S x 10	$I_{SEL} > 5 \text{ mA}$	$\pm (5 \% + 4 \text{ c ts})$
	$5 \text{ mA} > I_{SEL} > 0.5 \text{ mA}$	$\pm (15 \% + 10 \text{ cts})$

Current Measurement with GroundFlex®

Measurement Range	0.0 to 99.9 mA ⁽¹⁾	100 to 999 mA	1.00 to 9.99 A	10.0 to 99.9 A
Resolution	0.1 mA ⁽¹⁾	1 mA	0.01 A	0.1 A
Frequency	16 to 400Hz			
Accuracy	<5% of Reading @ 50/60Hz			

(1): Valid only in the SENSITIVITY x 10 setting

The current measured depends on the number of turns of the GroundFlex® sensor around the conductor to be measured. (e.g. if the GroundFlex® sensor is wrapped 4 times around a conductor carrying a current of 1 A, the input signal will be the same as if the GroundFlex® sensor were wrapped once around a conductor carrying a current of 4 A. The operating error is therefore indicated for an input signal current in A.tr (Ampere.turns).

The minimum current measured depends on the setting of the SENSITIVITY switch as indicated by the table below:

SENSITIVITY	I_{MIN} (A.tr)	Points additional error (pt-er)
x 10	0.01	5
x 1	0.04	2
x 1/10	0.16	2

Accuracy

Current (A * turn)	16 to 49 Hz	50 to 99 Hz	100 to 400 Hz
I_{MIN} to 0.399	$\pm (20 \% + \text{pt-er})$	$\pm (5 \% + \text{pt-er})$	$\pm (3 \% + \text{pt-er})$
0.4 to 39.9	$\pm (10 \% + 2 \text{ ct})$	$\pm (3 \% + 2 \text{ ct})$	$\pm (3 \% + 2 \text{ ct})$
40 to 99.9	$\pm (10 \% + 2 \text{ ct})$	$\pm (3 \% + 2 \text{ ct})$	$\pm (20 \% + 2 \text{ ct})$

3.2. MECHANICAL

Dimensions: (10.7 x 9.76 x 5.12) in (272, 248 x 130) mm

Weight: 7 lbs (3.2 kg) approx

Case Material: ULV0 Polypropylene

Terminals: 4 mm recessed banana jacks

Case Protection: EN 60529 - IP53 (cover closed)

Drop Test: Per EN 61010-1

Vibration Test: Per EN 61557-1

3.3. ENVIRONMENTAL

Operating Temperature: (32 to 113) °F (0 to 45) °C; (0 to 90) % RH

Specified Operating Temperature⁽¹⁾: (0 to 95) °F (0 to 35) °C; (0 to 75) % RH

Storage Temperature: (-40 to 158) °F (-40° to 70) °C; (0 to 90) % RH

Altitude: < 3000 m

(1): This range corresponds to the one defined by standard EN 61557, for which an operating error including the quantities of influence is defined. When the device is used outside this range, 1.5 %/10 °C and 1.5 % between 75 and 90 % RH must be added to the operating error.

3.4. SAFETY

Electromagnetic Compatibility

This instrument satisfies the EMC and LVD directives required for the CE marking and product standard IEC 61326-1 (Ed. 97) + A1 (Ed. 98).

- Immunity in industrial environment
- Emissions in residential environment.

Electrical safety according to EN 61010-1 (Ed. 2 of 2001)

Measurement according to EN 61557 (Ed. 2 of 2007) parts 1, 4 and 5.

CAT IV, 50 V

Pollution Degree 2

**Specifications are subject to change without notice*

4. MAINTENANCE



NOTE: Please make sure that you have read and fully understand the **Precautions for Use** section on page 6.

- To avoid electrical shock, do not attempt to perform any servicing unless you are qualified to do so.
- To avoid electrical shock and/or damage to the instrument, do not get water or other foreign agents into the case.
- Turn the instrument OFF and disconnect the unit from all circuits before opening the case.
- Use specified spare parts only.

4.1. CLEANING



WARNING: Disconnect the instrument from any source of electricity.

Use a soft cloth lightly moistened with soapy water. Wipe with a moist cloth and then dry with a dry cloth. Never use alcohol, solvents or hydrocarbons.

4.2. REPAIR AND CALIBRATION

To ensure that your instrument meets factory specifications, we recommend that it be sent back to our factory Service Center at one-year intervals for recalibration, or as required by other standards or internal procedures.

For instrument repair and calibration:

You must contact our Service Center for a Customer Service Authorization Number (CSA#). This will ensure that when your instrument arrives, it will be tracked and processed promptly. Please write the CSA# on the outside of the shipping container. If the instrument is returned for calibration, we need to know if you want a standard calibration, or a calibration traceable to N.I.S.T. (includes calibration certificate plus recorded calibration data).

Ship To:

(Or contact your authorized distributor.)

Contact us for the costs for repair, standard calibration, and calibration traceable to N.I.S.T.

NOTE: You must obtain a CSA# before returning any instrument.

4.3. TECHNICAL AND SALES ASSISTANCE

If you are experiencing any technical problems, or require any assistance with the proper operation or application of your instrument, please call, mail, fax, or e-mail our technical support team:

4.4. LIMITED WARRANTY

The instrument is warranted to the owner for a period of two years from the date of original purchase against defects in manufacture, unless the instrument was registered within 30 days of the purchase date (see warranty note below). This limited warranty is given by AEMC® Instruments, not by the distributor from whom it was purchased. This warranty is void if the unit has been tampered with, abused, or if the defect is related to service not performed by AEMC® Instruments.

IMPORTANT WARRANTY NOTE:

By registering online within 30 days of the purchase date, your warranty will be extended to 3 years.

Please print the online Warranty Coverage Information for your records.

What AEMC® Instruments will do:

If a malfunction occurs within the warranty period, you may return the instrument to us for repair, provided we have your warranty registration information on file or a proof of purchase. AEMC® Instruments will repair or replace the faulty material at their discretion.

4.4.1. Warranty Repairs

What you must do to return an Instrument for Warranty Repair:

First, request a Customer Service Authorization Number (CSA#) by phone or by fax from our Service Department (see address below), then return the instrument along with the signed CSA Form. Please write the CSA# on the outside of the shipping container. Return the instrument, postage or shipment pre-paid to:

Caution: To protect yourself against in-transit loss, we recommend you insure your returned material.

NOTE: You must obtain a CSA# before returning any instrument.
