

FLUKE®

1550C/1555

Insulation Tester

Users Manual

April 2010 Rev. 1, 3/18

© 2010-2018 Fluke Corporation. All rights reserved.

All product names are trademarks of their respective companies.

Specifications are subject to change without notice.

Find Quality Products Online at:

www.GlobalTestSupply.com

sales@GlobalTestSupply.com

LIMITED WARRANTY AND LIMITATION OF LIABILITY

Each Fluke product is warranted to be free from defects in material and workmanship under normal use and service. The warranty period is three years and begins on the date of shipment. Parts, product repairs, and services are warranted for 90 days. This warranty extends only to the original buyer or end-user customer of a Fluke authorized reseller, and does not apply to fuses, disposable batteries, or to any product which, in Fluke's opinion, has been misused, altered, neglected, contaminated, or damaged by accident or abnormal conditions of operation or handling. Fluke warrants that software will operate substantially in accordance with its functional specifications for 90 days and that it has been properly recorded on non-defective media. Fluke does not warrant that software will be error free or operate without interruption.

Fluke authorized resellers shall extend this warranty on new and unused products to end-user customers only but have no authority to extend a greater or different warranty on behalf of Fluke. Warranty support is available only if product is purchased through a Fluke authorized sales outlet or Buyer has paid the applicable international price. Fluke reserves the right to invoice Buyer for importation costs of repair/replacement parts when product purchased in one country is submitted for repair in another country.

Fluke's warranty obligation is limited, at Fluke's option, to refund of the purchase price, free of charge repair, or replacement of a defective product which is returned to a Fluke authorized service center within the warranty period.

To obtain warranty service, contact your nearest Fluke authorized service center to obtain return authorization information, then send the product to that service center, with a description of the difficulty, postage and insurance prepaid (FOB Destination). Fluke assumes no risk for damage in transit. Following warranty repair, the product will be returned to Buyer, transportation prepaid (FOB Destination). If Fluke determines that failure was caused by neglect, misuse, contamination, alteration, accident, or abnormal condition of operation or handling, including overvoltage failures caused by use outside the product's specified rating, or normal wear and tear of mechanical components, Fluke will provide an estimate of repair costs and obtain authorization before commencing the work. Following repair, the product will be returned to the Buyer transportation prepaid and the Buyer will be billed for the repair and return transportation charges (FOB Shipping Point).

THIS WARRANTY IS BUYER'S SOLE AND EXCLUSIVE REMEDY AND IS IN LIEU OF ALL OTHER WARRANTIES, EXPRESS OR IMPLIED, INCLUDING BUT NOT LIMITED TO ANY IMPLIED WARRANTY OF MERCHANTABILITY OR FITNESS FOR A PARTICULAR PURPOSE. FLUKE SHALL NOT BE LIABLE FOR ANY SPECIAL, INDIRECT, INCIDENTAL OR CONSEQUENTIAL DAMAGES OR LOSSES, INCLUDING LOSS OF DATA, ARISING FROM ANY CAUSE OR THEORY.

Since some countries or states do not allow limitation of the term of an implied warranty, or exclusion or limitation of incidental or consequential damages, the limitations and exclusions of this warranty may not apply to every buyer. If any provision of this Warranty is held invalid or unenforceable by a court or other decision-maker of competent jurisdiction, such holding will not affect the validity or enforceability of any other provision.

Table of Contents

Title	Page
Introduction	1
Safety Information	2
Before You Start	5
The Tester	5
Pushbuttons	6
Power On/Off	6
Display	7
Charge the Battery	7
Guard Terminal Use	8
Measurements	9
Connect to the Circuit Under Test	9
Before an Insulation Test	10
Preset Test Voltage Selection	10
Program a Test Voltage	10
Select a Ramp or Steady-State Test	11
Set a Timed Test	11
Polarization Index (PI)	11
Dielectric Absorption Ratio	12
Capacitance	12

Insulation Test	12
Store Test Results	13
View Test Results Stored in Memory	14
Download Test Results	15
Delete Test Results	16
Maintenance	16
Cleaning	16
Replaceable Parts and Accessories	17
General Specifications	18
Environmental Specifications	18
Electrical Specifications	20
Principles of Measurement and Resistance	21

Introduction

The Fluke 1550C and 1555 Insulation Testers (the Tester or Product) are high-voltage insulation testers to validate general circuits, such as switchgear, motors, and cables.

The Tester features:

- Large liquid crystal display (LCD)
- Preset test voltages: 250 V, 500 V, 1000 V, 2500 V, 5000 V, (10 000 V 1555 only)
- Programmable test voltages: 250 V to 10 000 V (50/100 V steps)
- Resistance measurement: 200 k Ω to 2 T Ω
- Polarization Index (PI)
- Dielectric Absorption Ratio (DAR or DAR [CN])
- Ramp mode that linearly increases (100 V/s) the applied test voltage
- Test timer and storage for test results with user-defined ID tag
- Breakdown voltage indication
- Rechargeable lead-acid battery
- Auto shutoff after 30 minutes of inactivity
- Infrared (IR) port for downloading test data
- PC software (supplied)

Safety Information

Warning identifies hazardous conditions and procedures that are dangerous to the user. A **Caution** identifies conditions and procedures that can cause damage to the Product or the equipment under test.

Warning

To prevent possible electrical shock, fire, or personal injury:

















- Carefully read all instructions.
- Read all safety information before you use the Product.
- Do not alter the Product and use only as specified, or the protection supplied by the Product can be compromised.
- Do not use the Product around explosive gas, vapor, or in damp or wet environments.
- Do not use the Product if it is altered or damaged.
- Do not use the Product if it operates incorrectly.
- Use Product-approved measurement category (CAT), voltage, and amperage rated accessories (probes, test leads, and adapters) for all measurements.
- Do not exceed the Measurement Category (CAT) rating of the lowest rated individual component of a Product, probe, or accessory.

- Do not use in CAT III or CAT IV environments without the protective cap installed on test probe. The protective cap decreases the exposed probe metal to <4 mm. This decreases the possibility of arc flash from short circuits.
- Comply with local and national safety codes. Use personal protective equipment (approved rubber gloves, face protection, and flame-resistant clothes) to prevent shock and arc blast injury where hazardous live conductors are exposed.
- Examine the case before you use the Product. Look for cracks or missing plastic. Carefully look at the insulation around the terminals.
- Do not use test leads if they are damaged. Examine the test leads for damaged insulation and measure a known voltage.
- Do not touch voltages >30 V ac rms, 42 V ac peak, or 60 V dc.
- Do not apply more than the rated voltage between the terminals or between each terminal and earth ground.
- Measure a known voltage first to make sure that the Product operates correctly.
- Limit operation to the specified measurement category, voltage, or amperage ratings.

- Remove all probes, test leads, and accessories that are not necessary for the measurement.
- Keep fingers behind the finger guards on the probes.
- Use the correct terminals, function, and range for measurements.
- Place test leads in proper input terminals.
- Do not work alone.
- Do not use in distribution systems with voltages higher than 1100 V.
- Use only recommended test leads.
- Remove all power from the circuit under test and discharge circuit capacitance before testing resistance or capacitor with the tester.
- Results of measurement can be adversely affected by the impedances of additional operating circuits connected in parallel or by transient currents.
- Before and after testing, confirm that the Product does not indicate the presence of a hazardous voltage. If a hazardous voltage is shown on the display, remove power from the circuit under test or allow the installation capacitance to fully discharge.
- Do not disconnect the test leads before a test has been completed and the test voltage at the terminals has returned to zero. This ensures that any charged capacitance is fully discharged.
- Use the guard terminal only as specified in this manual. Do not allow other foreign objects to contact the guard terminals as safety can be compromised.
- Remove the input signals before you clean the Product.
- Use only specified replacement parts.
- Repair the Product before use if the battery leaks.
- Do not operate the Product with covers removed or the case open. Hazardous voltage exposure is possible.
- Have an approved technician repair the Product.

Table 1 is a list of symbols used on the Product or in this manual.

Table 1. Symbols

Symbol	Description	Symbol	Description
	Consult user documentation.		Conforms to relevant South Korean EMC standards.
	WARNING. RISK OF DANGER.		Conforms to relevant Australian EMC standards.
	WARNING. HAZARDOUS VOLTAGE. Risk of electric shock.		Certified by CSA Group to North American safety standards.
	Earth		Conforms to European Union directives.
	AC (Alternating Current)		Certified by TÜV SÜD Product Service.
	Battery		Double Insulated
OK	Electrical breakdown		Interference is present. Displayed value might be outside of specified accuracy.
	WARNING. Do not apply greater than 1100 Volts.		Ramp mode indicator
CAT II	Measurement Category II is applicable to test and measuring circuits connected directly to utilization points (socket outlets and similar points) of the low-voltage MAINS installation.		
CAT III	Measurement Category III is applicable to test and measuring circuits connected to the distribution part of the building's low-voltage MAINS installation.		
CAT IV	Measurement Category IV is applicable to test and measuring circuits connected at the source of the building's low-voltage MAINS installation.		
	This product complies with the WEEE Directive marking requirements. The affixed label indicates that you must not discard this electrical/electronic product in domestic household waste. Product Category: With reference to the equipment types in the WEEE Directive Annex I, this product is classed as category 9 "Monitoring and Control Instrumentation" product. Do not dispose of this product as unsorted municipal waste.		

Before You Start

Table 2 is a list of the items included with your purchase. Carefully unpack and inspect each of the items.

Table 2. Pack List

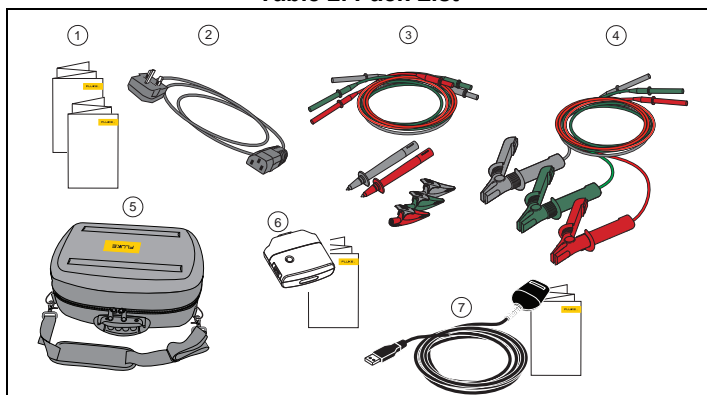

Item	Description
①	Quick Reference Guide and Safety Information
②	AC Power Cord
③	⚠ Test Cables with Alligator Clips (red, black, green) and Test Probes (red, black)
④	Heavy Duty Alligator Clips: Red, Black, Green (1555 and kits only) Available as optional accessory for 1550C, PN TLK1550-RTL
⑤	Soft Carrying Case (Kit includes Hard Case)
⑥	ir3000 FC BLE-IR Adapter with Quick Reference Guide (FC kits only)
⑦	Infrared Adapter/Interface Cable with Installation Guide

The Tester

This section is about the Tester and its operation. The Tester is shown in Table 3.

Table 3. 1550C/1555 Insulation Tester

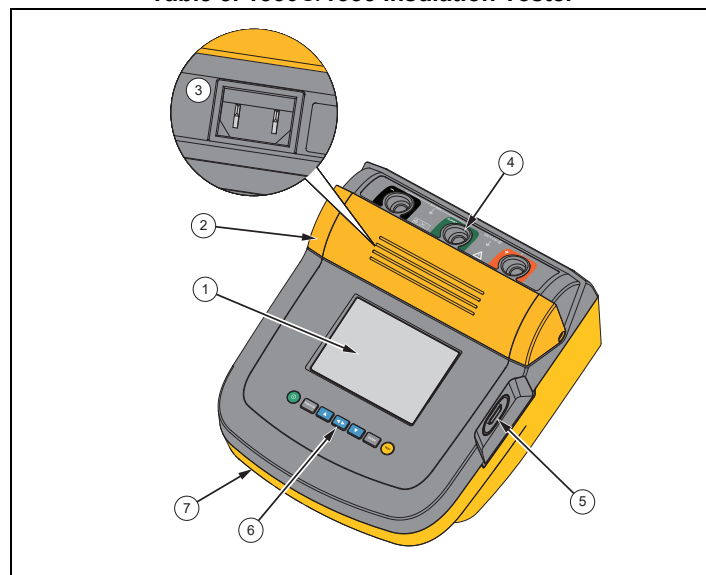

Item	Description
①	LCD
②	Safety Shutter
③	AC Plug
④	Input Terminals
⑤	IR Port
⑥	Pushbuttons
⑦	Built-in Handle

Pushbuttons

Use the pushbuttons to control the Tester, view test results, and scroll through chosen test results. See Table 4.

Table 4. Pushbuttons

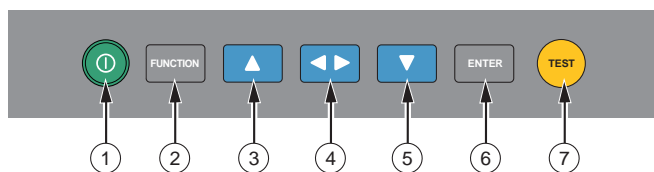

Item	Description
①	Power on/off.
②	Push FUNCTION to go to the Function menu. Push again to exit the Function menu. To scroll within the Function menu, use the arrow pushbuttons.
③	Scrolls through test voltages, stored test results, timer duration, and changes test tag ID characters. Use to answer "yes" to prompts.
④	After a memory location is set, ▶◀ displays the test parameters, test results stored in memory. These include voltage, capacitance, polarization index, dielectric absorption ratio, and current.
⑤	Use to scroll through test voltages, stored test results, timer duration, and memory locations. Use to answer "no" to prompts.
⑥	Use for Test Voltage mode to start incrementally setting the test voltage between 250 V and 10 000 V.
⑦	Starts and stops a test. Push and hold for 1 second to start a test. Push again to stop a test.

Use **▲** and **▼** to access these menu items:

1.X Insulation Functions:

- 1.1 Ramp off (default)
- 1.2 Ramp on
- 1.3 DAR T= 01-00
- 1.4 DAR/PI T= 10-00
- 1.5 DAR [CN]= 01-00

2 Time limit xx-xx

3 Show results

4 Delete results

Push **ENTER** to make the selection.

Power On/Off

Push **⓪** to turn on the Tester.

The Tester does a self-check, self-calibration, shows the software version, and starts in the Test Voltage mode.

In Test Voltage mode, you can:

- Change test parameters
- Start an insulation test
- View stored test results
- Download test results

Push **⓪** again to turn off the Tester.

Display

Table 5 is a list of features for the display.

Table 5. Display Features

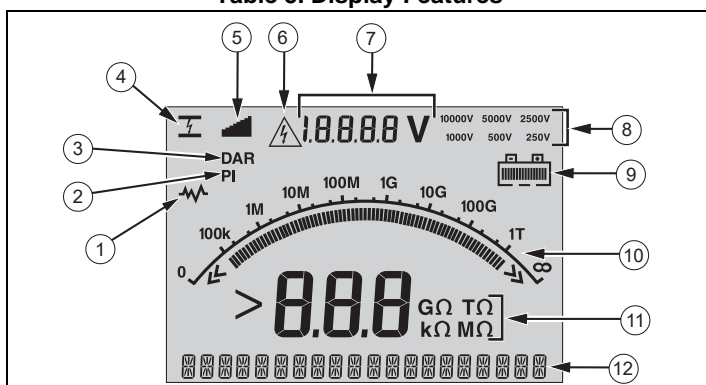

Item	Description
①	Interference present. Readings could be out of specified accuracy range.
②	Polarization Index.
③	Dielectric Absorption Ratio.
④	Electrical breakdown in Ramp mode.
⑤	Ramp mode indicator.
⑥	Possible hazardous voltage is at the test terminals.
⑦	Voltage sourced by the Tester or from the circuit under test at terminals of the Tester.
⑧	Test voltage selection (250 V, 500 V, 1000 V, 2500 V, 5000 V, or 10 000 V).
⑨	Battery charge status.
⑩	Bar graph display of insulation resistance.
⑪	Digital display of insulation resistance.
⑫	Text display. Shows voltage, test current, capacitance, programmable test voltages, and menu options.

Charge the Battery

This Tester uses a rechargeable 12 V lead-acid battery for power.

Storing rechargeable lead-acid batteries in a low-charged state could decrease their life and cause damage. Fully charge the battery before storing it for extended periods and examine the charge at regular intervals.

Charge the 12 V lead-acid battery with the ac power cord. Expect up to 12 hours to fully charge the battery. Do not charge in very high or low temperatures. Charge the battery if the Tester is not used for extended periods. Figure 1 shows how to connect the Tester to a power supply.

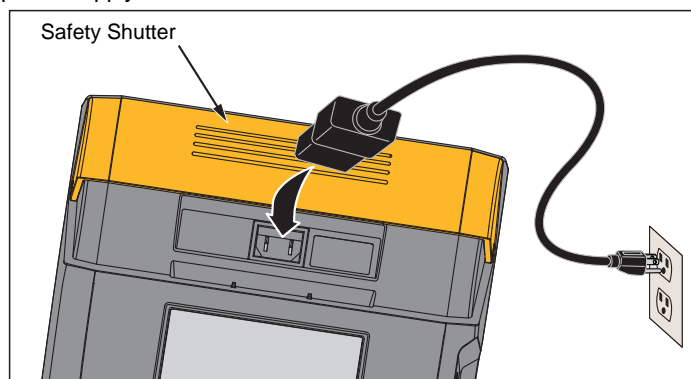

Figure 1. Power Supply Connections

To charge the battery with the ac power supply:

1. Turn off the Tester.
2. Disconnect the test leads from the Tester.
3. Move the safety shutter to access the power supply connection.
4. Connect the ac power cord to the IEC ac power socket on the Tester.
5. Connect the other end of the power cord to an ac power supply. See *General Specifications* for ac charger input specifications.

The LCD displays **CHARGING**. You are able to download test results while the Tester is in the charge mode.

Guard Terminal Use

Note

Insulation resistance is measured between the (+) and (-) output connections. The Guard terminal (G) is at the same potential as the negative (-) terminal but is not in the measurement path.

For most tests, only two test leads are used. Connect the positive (+) and negative (-) test leads to the corresponding inputs on the Tester. Connect the test lead probes to the circuit under test. The Guard (G) terminal is left unconnected.

For the best accuracy when you measure very high resistances, use three-wire measurements and the Guard terminal. The Guard terminal is at the same potential as the negative (-) terminal, and can be used to prevent surface leakage or other unwanted leakage currents from degrading the accuracy of the insulation resistance measurement.

Figure 2 shows how to measure the resistance from one of the conductors to the outer shield. In this case, there is a leakage current along the surface of the inner insulation near the cables end. This leakage adds to the current that the negative terminal senses, and causes the Tester to read a lower resistance than it should.

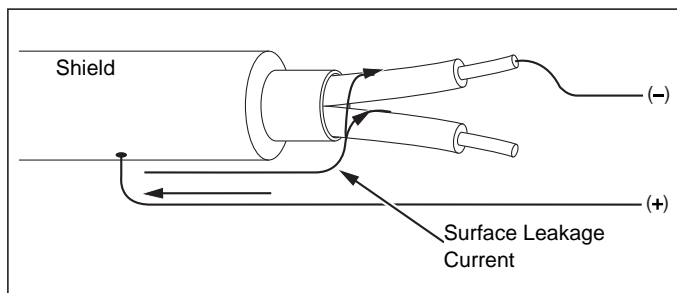

Figure 2. Surface Leakage Current

Figure 3 shows how to prevent surface current leakage with a lead connected from the Guard terminal to a conductor that surrounds the inner insulation. The surface leakage current is directed to the Guard terminal. This removes the leakage current from the measurement path between the positive and negative terminals, and improves the accuracy of the test readings.

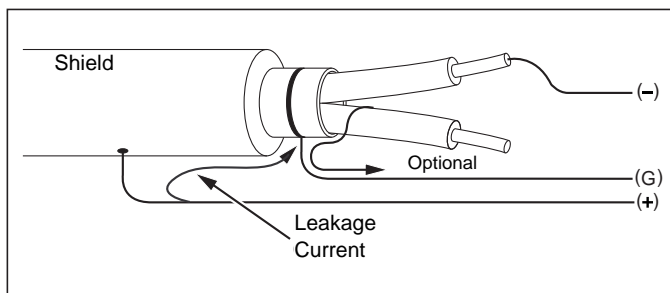

Figure 3. Guard Terminal Connection

Figure 4 shows how to make the measurement setup better. Connect the Guard terminal to the unused wire and attach it to the inner insulation. This ensures that the Tester measures the leakage between the selected conductor and the outer shield, but removes the leakage path between conductors.

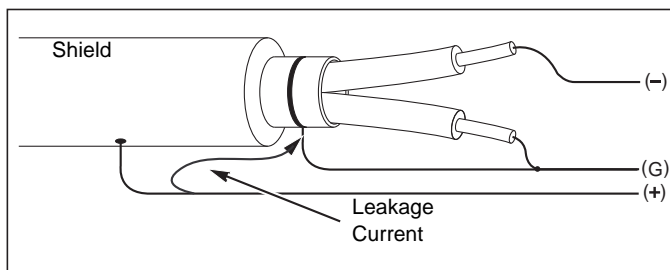

Figure 4. Improved Guard Terminal Connection

Measurements

Common measurement procedures are discussed in this section.

Connect to the Circuit Under Test

⚠⚠ Warning

To prevent possible electric shock, fire or personal injury:

- Remove all power from the circuit under test and discharge circuit capacitance before testing a circuit with the Product.
- Connect the common test lead before the live test lead and remove the live test lead before the common test lead.
- Before and after testing, confirm that the Product does not indicate the presence of a hazardous voltage, see Table 5. If the Tester beeps continuously and a hazardous voltage is shown on the display, remove power from the circuit under test and disconnect test leads.

To connect to the circuit under test:

1. Move the safety shutter to access the input terminals.
2. Put the test leads into the correct terminals shown, see Table 6.
3. Connect the test leads to the circuit under test.

Table 6. Test Lead Connections

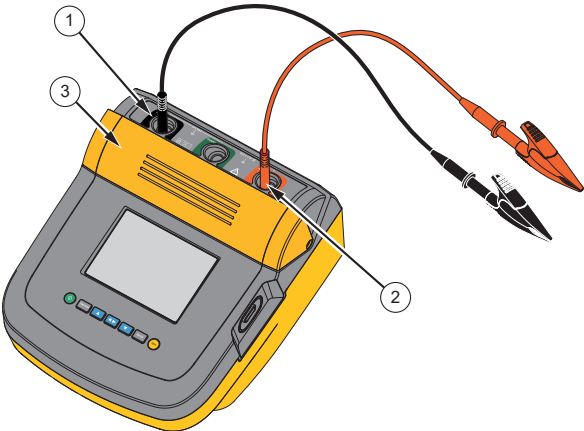

Item	Description
①	(-) Negative Terminal
②	(+) Positive Terminal
③	Safety Shutter

Note

The Tester is NOT specified for $<200\text{ k}\Omega$. When the leads are shorted and a test is performed, the Tester gives an unspecified reading that is >0 . This is normal for this input circuitry configuration and does not change readings that are in the specified accuracy range.

Before an Insulation Test

The Tester includes features and functions that let you adapt the test to your requirements. These features let you:

- define a test voltage
- make a ramp test selection
- set a time limit (duration) for the test
- measure polarization index (PI)
- measure dielectric absorption ratio (DAR or DAR[CN])
- measure capacitance

Use these alone or in combination. Set, clear, or account for (as appropriate) each feature before you start an insulation test. The features are discussed in this section.

Reset Test Voltage Selection

To make a preset test voltage selection:

- With the Tester turned on, push **FUNCTION** to select **TEST VOLTAGE**.

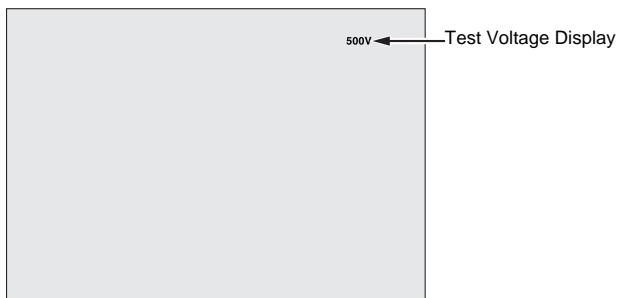

- Push **▲** or **▼** to scroll through the preset test voltage options (250 V, 500 V, 1000 V, 2500 V, 5000 V, and 10 000 V).

The test voltage selection shows in the upper-right of the display.

Note

The actual test voltage can be up to 10 % higher than the selected test voltage.

Program a Test Voltage

To set a test voltage in between the preset test voltages:

- Push **▲** or **▼** to scroll through the preset test voltage options (250 V, 500 V, 1000 V, 2500 V, 5000 V, and 10 000 V). Select the voltage closest to the level required.
- The selected test voltage appears in the upper-right of the display.
- Push **ENTER**.
TV=xxxxV flashes in the lower-left of the display.
- Push **▲** or **▼** to increment and decrement the voltage.
- When the correct voltage level shows, push **FUNCTION** to go to the function menu.

Do not push **ENTER**. Doing so will return the test voltage to a preset voltage selection.

Note

The test voltage can be up to 10 % higher than the test voltage you select.

Select a Ramp or Steady-State Test

The ramp-test function is an automated test that checks insulation for a breakdown. During a ramp test, the output voltage starts at 0 V and increases linearly (100 V/s) until it reaches the specified test voltage or until a sudden drop in measured resistance is detected. Then, the Ramp stops, the test voltage drops to zero, and the voltage at the breakdown point is stored in memory on the Tester. All other test results are declared invalid if the test does not reach the specified test voltage.

If the test successfully meets compliance without breakdown, then the only valid test results are test voltage and insulation resistance.

To enable or disable the ramp function:

1. With the Tester turned on, push **FUNCTION** to enter the 1.X Function Menu.
2. Push **ENTER** to call the menu item.
3. Push **U** or **▼** to toggle the Ramp on or off. When the ramp is on, a blinking  shows in the upper left-hand corner of the display.

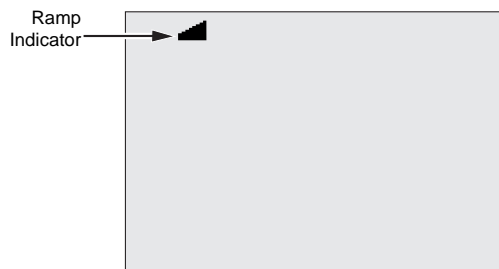

4. Push **ENTER** or **TEST** to use the settings. **TEST** starts the test.

Set a Timed Test

You can control the length of an insulation test by setting a timer. The time (test duration) can be set in 1-minute increments up to 99 minutes. During a timed test, the time limit appears on the right bottom of the display, and the elapsed time is shown in the middle of the display. At the end of the elapsed time, the insulation test has been completed and the test is terminated.

To set a test time limit:

1. With the Tester turned on, push **FUNCTION** to enter the Function Menu.
2. Push **▲** or **▼** to select the **2.Time Limit function**.
3. Push **ENTER** to call the menu item.
4. Push **▲** or **▼** to select the time.
5. Push **ENTER** or **TEST** to use the settings. **TEST** starts the test.

Polarization Index (PI)

As part of the insulation test, the Tester measures and stores polarization index (PI), when appropriate. A polarization index test requires 10 minutes to complete. Therefore, the Tester will start a countdown at 10 minutes. When an insulation test is 10 minutes or more, the polarization test is completed and stored. The results are available for display during a test by pushing the **▶** button or by storing the test results and scanning the **RESULTS** fields. The field is identified by:

$$PI = \frac{R @ 10 \text{ min}}{R @ 1 \text{ min}}$$

Dielectric Absorption Ratio

As part of the insulation test, the Tester measures and stores dielectric absorption ratio (DAR), when appropriate. A DAR test requires 30 minutes to complete. Therefore, it is measured and stored as invalid data for all insulation tests <1 minute. When an insulation test is >1 minute, the DAR test is included in the results. The results are available for display during a test by pushing the  button or by storing the test results and scanning the **RESULTS** fields. The field is identified by:

$$DAR = \frac{R @ 1 \text{ min}}{R @ 30 \text{ sec}}$$

The Tester also does the DAR test in accordance to the Chinese standards:

$$DAR [CN] = \frac{R @ 1 \text{ min}}{R @ 15 \text{ sec}}$$

Capacitance

As part of the insulation test, the Tester measures and stores capacitance when appropriate. The results are available for display during a test by pushing the  button or by storing the test results and scanning the **RESULTS** fields. The field is identified by **C=**.

Insulation Test

Warning

To prevent possible electric shock, fire, or personal injury:

- Be aware that insulation resistance measurement requires the application of potentially dangerous voltages to the circuit. This may include exposed bonded metalwork.
- Remove all power from the circuit under test and discharge circuit capacitance before you do a circuit test with the Product.
- Before proceeding, ensure that the installation is wired correctly and no personnel are endangered by any tests.
- Connect the test leads to the Product inputs before you make connection to the circuit under test.

PI/DAR Limits:

- Cap. Max >1 μF and Res. Max >100 MΩ
- Res. Min <200 kΩ
- Current min <50 mA
- If a limit is exceeded, the Tester shows **UNSPEC.** on the display.

To perform an insulation test:

1. With the Tester turned on, set the available measurement options to meet the test requirements. These include:
 - Test Voltage
 - Set range: 250 V to 1000 V (50 V steps)
 - Set range: 1000 V to 10 000 V (100 V steps)

Note

5000 V max for 1550C.

- Ramp Test – Toggle on or off
 - Time Limit – No limit or from 1 to 99 minutes
2. Connect the probes to the circuit under test.

⚠⚠ Warning

Before and after a test, confirm that the Product does not indicate the presence of a hazardous voltage. See Table 5. If the Product beeps continuously and a hazardous voltage is shown on the display, disconnect test leads and remove power from the circuit under test.

3. Push **TEST** for 1 second to start the insulation test.

The Tester beeps three times as the test begins, and **⚠** flashes on the display to indicate potentially hazardous voltages may be present on the test terminals.

The display indicates the measured insulation resistance after the circuit has stabilized. The bar graph displays this value continuously (in real time) as a trend, see Table 7.

Table 7. Measured Insulation Resistance Display

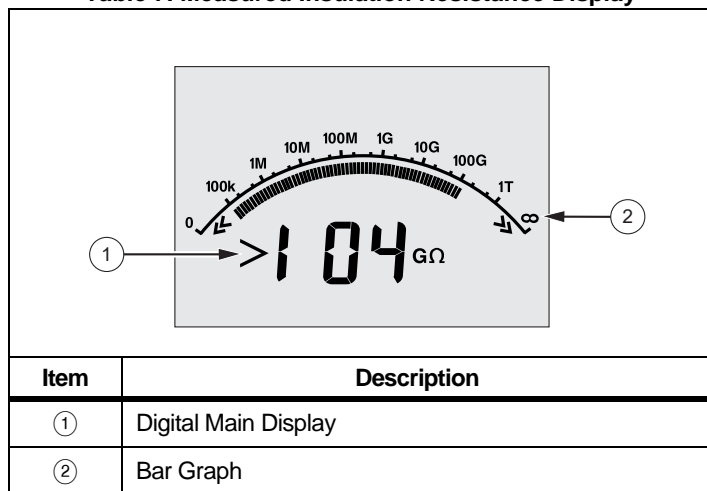

Any of these conditions terminate an insulation test:

- User stop (push **TEST**)
- Timer limit reached
- Interference on the test circuit
- Breakdown occurs with ramp test enabled
- Battery depleted

If breakdown occurs with ramp test enabled, push **ENTER** before going to step 4.

After the termination of an insulation test, the Tester beeps when a potentially hazardous voltage remains on the test terminals due to charged-circuit capacitance or from the presence of an external voltage.

4. When the test is terminated, **STORE RESULT?** shows on the display. If appropriate, store the test results. See *Store Test Results*. Or, push **▼** to terminate the **STORE RESULT?** prompt. The results are not stored.

Store Test Results

When the insulation test is complete, the Tester shows **STORE RESULT?** as a prompt to save the measurement results for future use. The Tester includes enough memory to store the results of 99 insulation tests.

To store the results of an insulation test:

1. Push **▲** to save the measurement results. The Tester will assign and display a sequential tag number (00 to 99) to identify the measurement.
2. If the tag number is acceptable, push **▲** again to store the data. If a different tagging convention is required, proceed as follows to provide a custom 4-character tag.

Notice that * is blinking on the display. This is the first of the four characters available for tagging the test results.

3. Repeatedly push **◀▶** to cycle through the character positions.

- At each character position use ▲ or ▼ to assign a character (0-9, A-Z).
- Push **ENTER** to store the results.

View Test Results Stored in Memory

Note

Parameters not appropriate for a test are shown as **INVALID**.

The Tester can store 99 sets of test data, including:

- Tags
- Ramp on or off
- Insulation Resistance
- Timer reading at termination of test (Timer)
- Test Voltage Selected (TV)
- Actual Test voltage (V)
- Capacitance I
- Polarization Index (PI)
- Dielectric absorption ratio (DAR or DAR[CN])
- Test current (I)
- Reason for ending the test
- Limit – off or timer setting from 1 to 99 minutes (T. Limit)

To view stored test data, see Table 8:

- With the Tester turned on, push **FUNCTION** to call the Function menu.
- Push ▲ or ▼ to select **3. Show Results**.
- Push **ENTER** to select the menu item.

Note

When a voltage is present at the terminals, that voltage is always shown on the top-center of the display, regardless of whether that voltage is sourced by the Tester or is from the circuit under test.

Table 8. Stored Test Data Display

The diagram shows a rectangular display area. At the top center, the text '1.0.0.0.0 V' is displayed, with a circled '1' and an arrow pointing to it. At the bottom left, the text 'C=0000 1 uF' is displayed, with a circled '3' and an arrow pointing to it. At the bottom right, the text '03' is displayed, with a circled '2' and an arrow pointing to it.

Item	Description
①	Voltage at terminals
②	Stored location
③	Stored test results

- Push ▲ or ▼ to step through the stored locations.
- Stop at the location you want to view.
- Push ◀▶ to view the stored test data for a specific test. Test data appears on the alphanumeric text display and on the LCD.
- Push **ENTER** to call the menu selection.

Download Test Results

You can use Fluke Connect® Desktop software to update your Product firmware and download all your stored test data to a PC. An infrared cable assembly is supplied for the Tester to PC connection.

With the ir3000 FC BLE-IR adapter option, you can use a smartphone or tablet and the Fluke Connect® app to download test results as well as view measurements simultaneously at the inspection site and from the office or an off-site location.

Table 9 shows the IR port and options.

Table 9. IR Port

Item	Description
1	IR Port
2	IR Cable Assembly (included)
3	ir3000 FC BLE-IR Adapter (option-PN 4460451)
4	Power On/Off

Note

Before the USB-IR cable can be used, software drivers must be installed on your Windows PC. See the USB-IR Installation Guide for more information.

IR Cable Assembly

To connect the Tester to the PC for use with *FC Desktop* software:

1. Make sure the Tester is not in the test mode. When in test mode, serial communications are disabled.
2. Connect the USB-IR cable to an available USB port on the PC.
3. Attach the USB-IR cable to the IR port on the Tester.
4. Open *FC Desktop* software.
5. Turn the Tester on.
6. Follow the prompts in the software.
7. Verify that the download was successful before deleting the stored test results on the Tester.

Note

Results data stored in the Tester can be deleted from the PC using the *FC Desktop* software.

Fluke Connect App

The Product supports the Fluke Connect® Wireless System (may not be available in all regions). Fluke Connect® uses low-power 802.15.4 wireless radio technology to wirelessly connect to an app on your smartphone or tablet. The wireless radio does not cause interference with measurements. The app shows measurements on your smartphone or tablet display, saves to Fluke Cloud™ storage, and shares the information with your team.

Note

Changes or modifications to the wireless 2.4 GHz radio not expressly approved by Fluke Corporation could void the user's authority to operate the equipment.

The Fluke Connect app works with Apple and Android mobile products. The app is available for download from the Apple App Store and Google Play.

To set up:

- Connect the ir3000 FC BLE-IR adapter to the IR port on the Tester.
- Turn on the adapter.

On your mobile device:

- Go to **Settings > Bluetooth**. Verify that Bluetooth is turned on.
- Go to the Fluke Connect app and in the list of connected Fluke tools, select **155x FC**.
- Follow the prompts in the app to continue.

Delete Test Results

To delete all saved test results:

- Push **FUNCTION** to call the Function menu.
- Push **▲** or **▼** to select the menu item **DELETE RESULT**.
- Push **ENTER** to call the menu item.
- Push **▲**. **REALLY DEL?** shows on the display.
- Push **▼** to confirm the deletion or push **ENTER** to return to **Test Voltage**.

Note

The Delete function deletes all stored test results. Individual test locations cannot be deleted but are overwritten.

Maintenance

⚠⚠ Warning

To prevent possible electric shock, fire, or personal injury:

- Do not repair or service your Product beyond what is described in this manual.
- Have an approved technician repair the Product.
- There are no user-replaceable parts inside the Product.

Cleaning

⚠⚠ Warning

To prevent possible electric shock, fire, or personal injury, remove excess water from the cloth before you clean the Product to ensure that water does not enter any terminal.

Periodically wipe the case with a damp cloth and mild detergent. Do not use abrasives or solvents to clean the Product.

Replaceable Parts and Accessories

Table 10 is a list of the replaceable parts for the Product. Table 11 is a list of the available accessories.

Table 10. Replaceable Parts

Part	Part Number
TL1550B, includes: Test Leads (Red, Black, Green) Test Clips (Red, Black, Green) Test Probes (Red, Black)	2788216
AC Power Cord (North America)	284174
AC Power Cord (Continental Europe)	769422
AC Power Cord (UK)	769455
AC Power Cord (Australia)	658641
AC Power Cord (S. Africa)	1552363
Soft Carrying Case	3592805
Infrared Cable Assembly	1578406
Quick Reference Card	3592822

Table 11. Accessories

Accessory	Part Number
Extended Test Lead Set, 25 feet (7.6 meters)	2032761
Rugged Alligator Clamps Leads	4112351
Soft Case	3592805
Hard Case	4253708
ir3000 FC BLE-IR Adapter	4460451

General Specifications

Display.....	475 mm x 105 mm
Power.....	12 V lead-acid rechargeable battery, 2.6 Ahr
Typical Battery Charge Capacity	
Number of tests.....	4100 @ 250 V 3600 @ 500 V 3200 @ 1 kV 2500 @ 2.5 kV 1000 @ 5 kV 500 @ 10 kV
At temperature extremes.....	charge the battery more frequently
Charger Input (AC).....	85 V to 250 V ac, 50/60 Hz, 20 VA This Class II (double insulated) instrument is supplied with a Class 1 (grounded) power cord. The protective earth terminal (ground pin) is not connected internally. The extra pin is for added plug retention only.
Dimensions (H x W x L).....	170 mm x 242 mm x 330 mm (6.7 in. x 9.5 in. x 13.0 in.)
Weight.....	3.6 kg (7.94 lb)
Lock Protection.....	Kensington lock

Environmental Specifications

Operating Temperature.....	-20 °C to +50 °C (-4 °F to +122 °F)
Storage Temperature.....	-20 °C to +65 °C (-4 °F to +149 °F)
Relative Humidity.....	80 % to 31 °C decreasing linearly to 50 % at 50 °C
Altitude.....	2000 m
IP Rating.....	IEC 60529: IP40

Safety IEC 61010-1: 600 V CAT IV / 1000 V CAT III Pollution Degree 2

Electromagnetic Compatibility (EMC)

International IEC 61326-1: Portable
CISPR 11: Group 1, Class A

Group 1: Equipment has intentionally generated and/or uses conductively-coupled radio frequency energy that is necessary for the internal function of the equipment itself.

Class A: Equipment is suitable for use in all establishments other than domestic and those directly connected to a low-voltage power supply network that supplies buildings used for domestic purposes. There may be potential difficulties in ensuring electromagnetic compatibility in other environments due to conducted and radiated disturbances.

Caution: This equipment is not intended for use in residential environments and may not provide adequate protection to radio reception in such environments.

Emissions that exceed the levels required by CISPR 11 can occur when the equipment is connected to a test object.

Korea (KCC)..... Class A Equipment (Industrial Broadcasting & Communication Equipment)

Class A: Equipment meets requirements for industrial electromagnetic wave equipment and the seller or user should take notice of it. This equipment is intended for use in business environments and not to be used in homes.

USA (FCC) 47 CFR 15 subpart B. This product is considered an exempt device per clause 15.103.

Wireless Radio with Adapter

Frequency Range..... 2412 MHz to 2462 MHz

Output Power <100 mW

Electrical Specifications

The Tester accuracy is specified for 1 year after calibration at operating temperatures of 0 °C to 35 °C. For operating temperatures outside the range -20 °C to 0 °C and 35 °C to 50 °C, add ± 0.25 % per °C, except on the 20 % bands add ± 1 % per °C.

Insulation		
Test Voltage (DC)	Insulation Resistance Range	Accuracy (\pm reading)
250 V	<250 k Ω 250 k Ω to 5 G Ω 5 G Ω to 50 G Ω >50 G Ω	unspecified 5 % 20 % unspecified
500 V	<500 k Ω 500 k Ω to 10 G Ω 10 G Ω to 100 G Ω >100 G Ω	unspecified 5 % 20 % unspecified
1000 V	<1 M Ω 1 M Ω to 20 G Ω 20 G Ω to 200 G Ω >200 G Ω	unspecified 5 % 20 % unspecified
2500 V	<2.5 M Ω 2.5 M Ω to 50 G Ω 50 G Ω to 500 G Ω >500 G Ω	unspecified 5 % 20 % unspecified
5000 V	<5 M Ω <5 M Ω to 100 G Ω 100 G Ω to 1 T Ω >1 T Ω	unspecified 5 % 20 % unspecified
10 000 V	<10 M Ω 10 M Ω to 200 G Ω 200 G Ω to 2 T Ω >2 T Ω	unspecified 5 % 20 % unspecified
Bar graph range: Insulation test voltage accuracy: Induced ac mains current rejection: Charging rate for capacitive load: Discharge rate for capacitive load:		0 to 2 T Ω -0 %, +10 % at 1 mA load current 2 mA maximum 5 s/ μ F 1.5 s/ μ F

Measurement	Range	Accuracy
Leakage Current	1 nA to 2 mA	±(20 % + 2 nA)
Capacitance	0.01 µF to 20.00 µF	±(15 % of reading + 0.03 µF)

Timer	Range	Resolution
	0 to 99 minutes	Setting: 1 minute Indication: 1 second

Live circuit warning	Warning Range	Voltage Accuracy
	30 V to 1100 V ac/dc, 50/60 Hz	±(15 % + 2 V)

Short circuit current>1 mA and <2 mA

Principles of Measurement and Resistance

The Tester measures insulation parameters and displays the results using with the following formulas.

Ohm's Law	Capacitance (charge)	PI (Polarization Index)	DAR (Dielectric absorption ratio)	DAR [CN] (Dielectric absorption ratio)
$R = \frac{V}{I}$	$C = \frac{Q}{V}$	$PI = \frac{R @ 10 \text{ min}}{R @ 1 \text{ min}}$	$DAR = \frac{R @ 1 \text{ min}}{R @ 30 \text{ sec}}$	$DAR [CN] = \frac{R @ 1 \text{ min}}{R @ 15 \text{ sec}}$