

**FLUKE®**

**114, 115, and 117**  
True-rms Multimeters

**Users Manual**

PN 2572573  
July 2006, Rev. 1, 2/07  
© 2006, 2007 Fluke Corporation, All rights reserved. Printed in China  
All product names are trademarks of their respective companies.

**LIMITED WARRANTY AND LIMITATION OF LIABILITY**

This Fluke product will be free from defects in material and workmanship for three years from the date of purchase. This warranty does not cover fuses, disposable batteries, or damage from accident, neglect, misuse, alteration, contamination, or abnormal conditions of operation or handling. Resellers are not authorized to extend any other warranty on Fluke's behalf. To obtain service during the warranty period, contact your nearest Fluke authorized service center to obtain return authorization information, then send the product to that Service Center with a description of the problem.

THIS WARRANTY IS YOUR ONLY REMEDY. NO OTHER WARRANTIES, SUCH AS FITNESS FOR A PARTICULAR PURPOSE, ARE EXPRESSED OR IMPLIED. FLUKE IS NOT LIABLE FOR ANY SPECIAL, INDIRECT, INCIDENTAL OR CONSEQUENTIAL DAMAGES OR LOSSES, ARISING FROM ANY CAUSE OR THEORY. Since some states or countries do not allow the exclusion or limitation of an implied warranty or of incidental or consequential damages, this limitation of liability may not apply to you.

Fluke Corporation  
P.O. Box 9090  
Everett, WA 98206-9090  
U.S.A.

Fluke Europe B.V.  
P.O. Box 1186  
5602 BD Eindhoven  
The Netherlands

11/99

# True-rms Multimeters

## Introduction

The Fluke **Model 114**, **Model 115**, and **Model 117** are battery-powered, true-rms multimeters (hereafter "the Meter") with a 6000-count display and a bar graph. This manual applies to all three models. All figures show the Model 117.

These meters meet CAT III IEC 61010-1 2<sup>nd</sup> Edition standards. The IEC 61010-1 2<sup>nd</sup> Edition safety standard defines four measurement categories (CAT I to IV) based on the magnitude of danger from transient impulses. CAT III meters are designed to protect against transients in fixed-equipment installations at the distribution level.

## Unsafe Voltage

To alert you to the presence of a potentially hazardous voltage, the  $\text{⚡}$  symbol is displayed when the Meter measures a voltage  $\geq 30$  V or a voltage overload (OL) condition. When making frequency measurements  $> 1$  kHz, the  $\text{⚡}$  symbol is unspecified.

## Test Lead Alert

### Warning

**Personal injury or damage to the Meter can occur if you attempt to make a measurement with a lead in an incorrect terminal.**

To remind you to check that the test leads are in the correct terminals,  $\text{LEAd}$  is briefly displayed and an audible beep sounds when you move the rotary switch to or from any **A** (Amps) position.

**114, 115, and 117**  
*Users Manual*

---

**Safety Information**

A "⚠⚠ **Warning**" statement identifies hazardous conditions and actions that could cause bodily harm or death.

A "⚠ **Caution**" statement identifies conditions and actions that could damage the Meter or the equipment under test.









**To avoid possible electric shock or personal injury, follow these guidelines:**

- **Use the Meter only as specified in this manual or the protection provided by the Meter might be impaired.**
- **Do not use the Meter or test leads if they appear damaged, or if the Meter is not operating properly.**
- **Always use proper terminals, switch position, and range for measurements.**
- **Verify the Meter's operation by measuring a known voltage. If in doubt, have the Meter serviced.**
- **Do not apply more than the rated voltage, as marked on Meter, between terminals or between any terminal and earth ground.**
- **Use caution with voltages above 30 V ac rms, 42 V ac peak, or 60 V dc. These voltages pose a shock hazard.**
- **Disconnect circuit power and discharge all high-voltage capacitors before testing resistance, continuity, diodes, or capacitance.**
- **Do not use the Meter around explosive gas or vapor.**
- **When using test leads or probes, keep your fingers behind the finger guards.**
- **Only use test leads that have the same voltage, category, and amperage ratings as the meter and that have been approved by a safety agency.**
- **Remove test leads from Meter before opening the battery door or Meter case.**

**True-rms Multimeters**  
Safety Information

- Comply with local and national safety requirements when working in hazardous locations.
- Use proper protective equipment, as required by local or national authorities when working in hazardous areas.
- Avoid working alone.
- Use only the replacement fuse specified or the protection may be impaired.
- Check the test leads for continuity before use. Do not use if the readings are high or noisy.
- Do not use the Auto Volts function to measure voltages in circuits that could be damaged by this function's low input impedance ( $\approx 3 \text{ k}\Omega$ ) (114 and 117 only).

Symbols

|   |   |   |  |
|---|---|---|--|
| ~   | AC (Alternating Current)  |  | Fuse                                   |
| =   | DC (Direct Current)   |  | Double Insulated                       |
|  | Hazardous voltage   |  | Important Information; Refer to manual |
|  | Battery (Low battery when shown on the display.)  |  | Earth ground                           |
|  | Do not dispose of this product as unsorted municipal waste. Contact Fluke or a qualified recycler for disposal. |  | AC and DC                              |

**114, 115, and 117**  
Users Manual

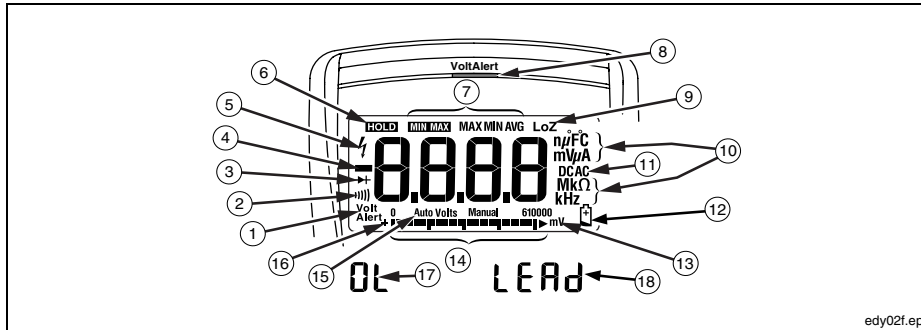

**Display**



edy02f.eps

| No. | Symbol     | Meaning   | Model           |
|-----|------------|---|-----------------|
| ①   | Volt Alert | The Meter is in the VoltAlert™ non-contact voltage detect mode.                           | 117             |
| ②   |            | The Meter function is set to Continuity.  | 114, 115, & 117 |
| ③   | → ←        | The Meter function is set to Diode Test   | 115 & 117       |
| ④   | -          | Input is a negative value.  | 114, 115, & 117 |
| ⑤   | ⚡          | ⚠ Unsafe voltage. Measured input voltage $\geq 30$ V, or voltage overload condition (OL). | 114, 115, & 117 |

**True-rms Multimeters**  
*Display*

|   |   |   |   |
|---|---|---|---|
| ⑥ | <b>HOLD</b>   | Display hold enabled. Display freezes present reading.  | 114, 115, & 117                                 |
| ⑦ | <b>MIN MAX</b><br><b>MAX MIN AVG</b>  | MIN MAX AVG mode enabled.<br>Maximum, minimum, average or present reading displayed   | 114, 115, & 117                                 |
| ⑧ | <b>(Red LED)</b>  | Voltage presence through the non-contact VoltAlert sensor   | 117   |
| ⑨ | <b>LoZ</b>  | The Meter is measuring voltage or capacitance with a low input impedance.   | 114, 115 & 117                                  |
| ⑩ | <b>µF mVµA</b><br><b>MkΩ kHz</b>  | Measurement units.  | 114, 115, & 117                                 |
| ⑪ | <b>DC AC</b>  | Direct current or alternating current   | 114, 115 & 117                                  |
| ⑫ |  | Battery low warning.  | 114, 115, & 117                                 |
| ⑬ | <b>610000 mV</b>  | Indicates the Meter's range selection.  | 114, 115, & 117                                 |
| ⑭ | <b>(Bar graph)</b>  | Analog display.   | 114, 115, & 117                                 |
| ⑮ | <b>Auto Volts</b><br><b>Auto</b><br><b>Manual</b>                                   | The Meter is in the Auto Volts function.<br>Autoranging. The Meter selects the range for best resolution.<br>Manual ranging. User sets the Meter's range.   | 114 & 117<br>114, 115, & 117<br>114, 115, & 117 |
| ⑯ | <b>+</b>  | Bar graph polarity  | 114, 115, & 117                                 |
| ⑰ | <b>OL</b>   |  The input is too large for the selected range.  | 114, 115, & 117                                 |
| ⑱ | <b>LEAD</b>   |  Test lead alert. Briefly displayed whenever the Meter's function switch is rotated to or from any A position. | 115 & 117                                       |

**114, 115, and 117**  
Users Manual

**Terminals**

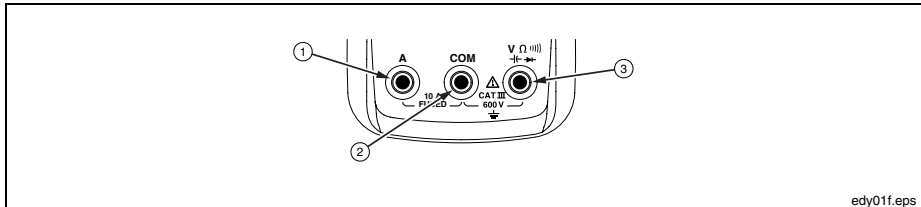

edy01f.eps

| No. | Description  | Model           |
|-----|--|-----------------|
| ①   | Input terminal for measuring ac and dc current to 10 A.  | 115 & 117       |
| ②   | Common (return) terminal for all measurements.   | 114, 115, & 117 |
| ③   | Input terminal for measuring voltage, continuity, resistance, capacitance, frequency and testing diodes. | 114, 115, & 117 |

| Error Messages   |  |
|------------------|--|
| <b>Batt</b>      | Battery must be replaced before the Meter will operate.                            |
| <b>CAL Err</b>   | Calibration required. Meter calibration is required before the Meter will operate. |
| <b>EEP Err</b>   | Internal error. The Meter must be repaired before it will operate.                 |
| <b>F I D Err</b> | Internal error. The Meter must be repaired before it will operate.                 |



**True-rms Multimeters**  
**Rotary Switch Positions**

**Rotary Switch Positions**

| Switch Position   | Measurement Function  | Model                       |
|---|---|-----------------------------|
| <b>AUTO-V</b><br><b>LoZ</b>   | Automatically selects ac or dc volts based on the sensed input with a low impedance input.  | 114 & 117                   |
| $\tilde{V}$ Hz<br><b>Hz (button)</b>  | AC voltage from 0.06 to 600 V.<br>Frequency from 5 Hz to 50 kHz.  | 114, 115 & 117<br>115 & 117 |
| $\bar{V}$   | DC voltage from .001 V to 600 V.  | 114, 115 & 117              |
| $\tilde{mV}$  | AC voltage from 6.0 to 600 mV, dc-coupled. DC voltage from 0.1 to 600 mV.   | 114, 115 & 117              |
| $\Omega$  | Ohms from 0.1 $\Omega$ to 40 M $\Omega$ .   | 114, 115 & 117              |
| $\text{   }$  | Continuity beeper turns on at < 20 $\Omega$ and turns off at >250 $\Omega$ .  | 114, 115 & 117              |
| $\rightarrow $  | Diode Test. Displays OL above 2.0 V.  | 115 & 117                   |
| $\text{   }$  | Farads from 1 nF to 9999 $\mu$ F.   | 115 & 117                   |
| $\tilde{A}$ Hz<br><b>Hz (button)</b>  | AC current from 0.1 A to 10 A (>10 to 20 A, 30 seconds on, 10 minutes off).<br>>10.00 A display flashes. >20 A, <b>OL</b> is displayed. DC-coupled.<br>Frequency from 45 Hz to 5 kHz. | 115 & 117                   |
| $\bar{A}$   | DC current from 0.001 A to 10 A (>10 to 20 A, 30 seconds on, 10 minutes off).<br>>10.00 A display flashes. >20 A, <b>OL</b> is displayed.   | 115 & 117                   |
| <b>Volt Alert</b>   | Non-contact sensing of ac voltage.  | 117                         |
| Note: All ac functions and Auto-V LoZ are true-rms. AC voltage is ac-coupled. Auto-V LoZ, AC mV and AC amps are dc-coupled. |   |                             |

## 114, 115, and 117 Users Manual





---

### Battery Saver ("Sleep Mode")

The Meter automatically enters "Sleep mode" and blanks the display if there is no function change, range change, or button press for 20 minutes. Pressing any button or turning the rotary switch awakens the Meter. To disable the Sleep mode, hold down the  button while turning the Meter on. The Sleep mode is always disabled in the MIN MAX AVG mode.

### MIN MAX AVG Recording Mode

The MIN MAX AVG recording mode captures the minimum and maximum input values (ignoring overloads), and calculates a running average of all readings. When a new high or low is detected, the Meter beeps.



- Put the Meter in the desired measurement function and range.
- Press  to enter MIN MAX AVG mode.
- **MIN MAX** and MAX are displayed and the highest reading detected since entering MIN MAX AVG is displayed.
- Press  to step through the low (MIN), average (AVG), and present readings.
- To pause MIN MAX AVG recording without erasing stored values, press . **HOLD** is displayed.
- To resume MIN MAX AVG recording, press  again.
- To exit and erase stored readings, press  for at least one second or turn the rotary switch.

### Display HOLD

#### Warning

**To avoid electric shock, when Display HOLD is activated, be aware that the display will not change when you apply a different voltage.**

In the Display HOLD mode, the Meter freezes the display.

1. Press  to activate Display HOLD. (**HOLD** is displayed.)
2. To exit and return to normal operation, press  or turn the rotary switch.

### Backlight

Press  to toggle the backlight on and off. The backlight automatically turns off after 40 seconds. To disable backlight auto-off, hold down  while turning the Meter on.

### Manual and Autoranging

The Meter has both Manual and Autorange modes.

- In the Autorange mode, the Meter selects the range with the best resolution.
- In the Manual Range mode, you override Autorange and select the range yourself.

## True-rms Multimeters Power-Up Options

When you turn the Meter on, it defaults to Autorange and **Auto** is displayed.

1. To enter the Manual Range mode, press **RANGE** . **Manual** is displayed.
2. In the Manual Range mode, press **RANGE** to increment the range. After the highest range, the Meter wraps to the lowest range.

*Note*



*You cannot manually change the range in the MIN MAX AVG or Display HOLD modes.*

*If you press **RANGE** while in MIN MAX AVG or Display Hold, the Meter beeps twice, indicating an invalid operation and the range does not change.*

3. To exit Manual Range, press **RANGE** for at least 1 second or turn the rotary switch. The Meter returns to Autorange and **Auto** is displayed.

### **Power-Up Options**

To select a Power-Up Option, hold down the button indicated in the following table while turning the Meter on. Power-Up Options are canceled when you turn the Meter off and when sleep mode is activated.

| Button  | Power-Up Options  |
|---|---|
| <b>HOLD</b>   | Turns on all display segments.  |
| <b>MIN MAX</b>  | Disables beeper. <b>bEEP</b> is displayed when enabled.   |
| <b>RANGE</b>  | Enables low impedance capacitance measurements. <b>LCAP</b> is displayed when enabled. See page 14. |
|  | Disables automatic power-down ("Sleep mode"). <b>PaFF</b> is displayed when enabled.                |
|  | Disables auto backlight off. <b>LaFF</b> is displayed when enabled.                                 |

### **Making Basic Measurements**

The figures on the following pages show how to make basic measurements.

When connecting the test leads to the circuit or device, connect the common (**COM**) test lead before connecting the live lead; when removing the test leads, remove the live lead before removing the common test lead.

114, 115, and 117  
Users Manual

**Measuring Resistance**

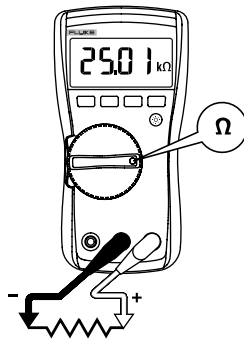

edy04f.eps

**Warning**

To avoid electric shock, injury, or damage to the Meter, disconnect circuit power and discharge all high-voltage capacitors before testing resistance, continuity, diodes, or capacitance.

**Testing for Continuity**

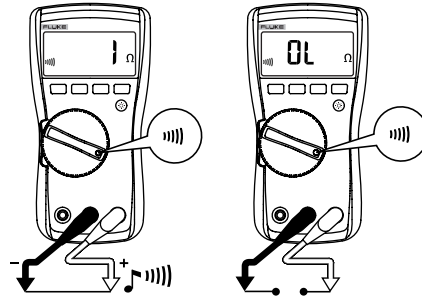

edy06f.eps

**Note**

The continuity function works best as a fast, convenient method to check for opens and shorts. For maximum accuracy in making resistance measurements, use the Meter's resistance (Ω) function.

## True-rms Multimeters Making Basic Measurements

### Measuring AC and DC Voltage

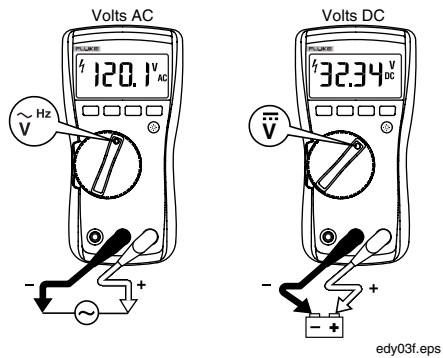



### Using Auto Volts Selection (114 & 117 only)

With the function switch in the  $\text{AUTO-V}_{\text{LoZ}}$  position, the Meter automatically selects a dc or ac voltage measurement based on the input applied between the **V** or **+** and **COM** jacks.

This function also sets the Meter's input impedance to approximately  $3 \text{ k}\Omega$  to reduce the possibility of false readings due to ghost voltages.

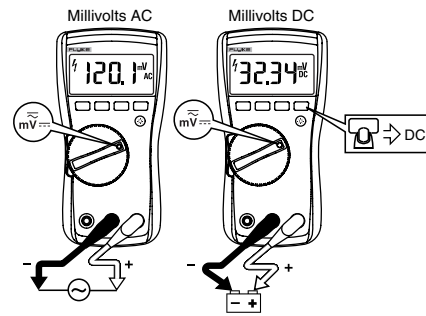
### Measuring AC and DC Millivolts



With the function switch in the  $\text{mV}_{\text{LoZ}}$  position, the Meter measures ac plus dc millivolts. Press  to switch the Meter to dc millivolts.

**114, 115, and 117**  
*Users Manual*

---

**Measuring AC or DC Current (115 & 117)**

**⚠⚠ Warning**

To avoid personal injury or damage to the Meter:

- Never attempt to make an in-circuit current measurement when the open-circuit potential to earth is >600 V.
- Check the Meter's fuse before testing. (See "Testing the Fuse")
- Use the proper terminals, switch position, and range for your measurement.
- Never place the probes in parallel with a circuit or component when the leads are plugged into the A (Amps) terminals.

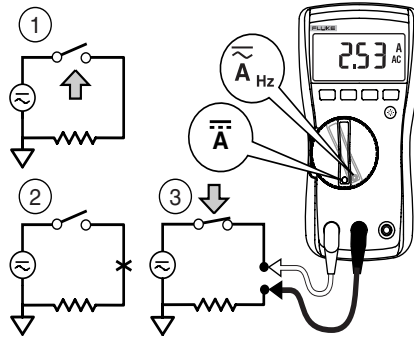

edy08f.eps

Turn circuit power off, break the circuit, insert the Meter in series with the circuit, and then turn circuit power on.

**True-rms Multimeters**  
**Making Basic Measurements**

**Measuring Current above 10 Amps**

The millivolt and voltage function of the Meter can be used with an optional mV/A output Current Probe to measure currents that exceed the rating of the Meter. Make sure the Meter has the correct function selected, AC or DC, for your current probe. Refer to a Fluke catalog or contact your local Fluke representative for compatible current clamps.

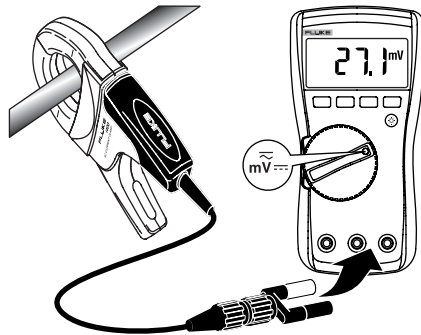

edy14f.eps

**Measuring Capacitance (115 & 117 only)**

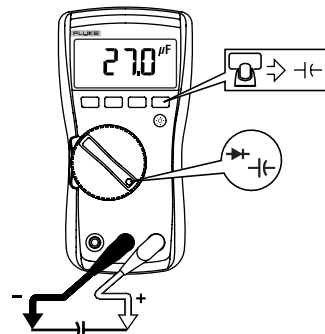

edy05f.eps

**114, 115, and 117**  
Users Manual

**Measuring Frequency (115 & 117 only)**

**⚠ Warning**

To avoid electrical shock, disregard the bar graph for frequencies >1 kHz. If the frequency of the measured signal is >1 kHz, the bar graph and  $\frac{1}{4}$  are unspecified.

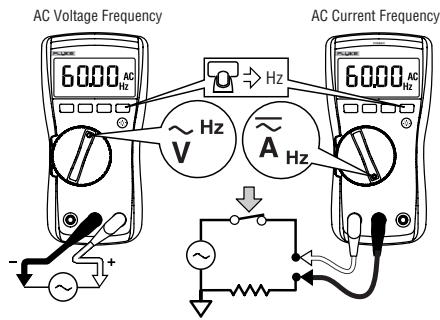

The Meter measures the frequency of a signal by counting the number of times the signal crosses a trigger level each second. The trigger level is 0 V, 0 A for all ranges. edy09f.eps

Press  $\square$  to turn the frequency measurement function on and off. Frequency works with ac functions only.

In frequency, the bar graph and range annunciator indicate the ac voltage or current present.

Select progressively lower ranges using manual ranging for a stable reading.

**Detecting AC Voltage Presence (117 only)**

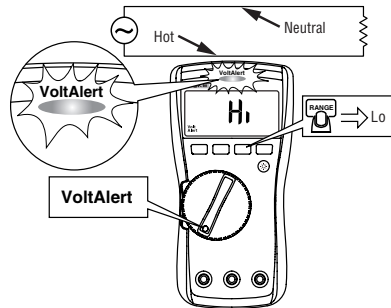

edy13f.eps



## True-rms Multimeters Making Basic Measurements

To detect the presence of ac voltage, place the top of the Meter close to a conductor. The Meter gives an audible as well as visual indication when voltage is detected. There are two sensitivity settings. The "Lo" setting can be used on flush mounted wall sockets, power strips, flush mounted industrial outlets and various power cords. The "H" setting allows for ac voltage detection on other styles of recessed power connectors or sockets where the actual ac voltage is recessed within the connector itself. The VoltAlert detector works in bare wire applications with voltages as low as 24 V in the "H" setting.

### ⚠⚠ Warning

**If there is no indication, voltage could still be present. Do not rely on the VoltAlert detector with shielded wire. Operation may be effected by differences in socket design, insulation thickness and type.**

### Making Low Impedance Capacitance Measurements (115 & 117 only)

For making capacitance measurements on cables with ghost voltage, hold **[RANGE]** while turning on the Meter to switch the Meter into LoZ, (low input impedance) Capacitance mode. In this mode, capacitance measurements will have a lower accuracy and lower dynamic range. This setting is not saved when the Meter is turned off or goes into sleep mode.

### Testing Diodes (115 & 117)

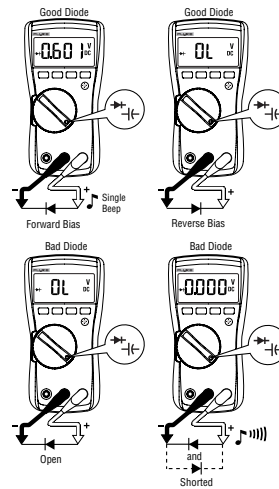

edy07f.eps

## 114, 115, and 117 Users Manual

### Using the Bargraph

The bar graph is like the needle on an analog meter. It has an overload indicator (▶) to the right and a polarity indicator (+) to the left.

Because the bar graph is much faster than the digital display, the bar graph is useful for making peak and null adjustments.

The bar graph is disabled when measuring capacitance. In frequency, the bar graph and range annunciator indicates the underlying voltage or current up to 1 kHz.

*The number of segments indicates the measured value and is relative to the full-scale value of the selected range.*

In the 60 V range, for example (see below), the major divisions on the scale represent 0, 15, 30, 45, and 60 V. An input of -30 V turns on the negative sign and the segments up to the middle of the scale.



aej11f.eps

### Testing the Fuse (115 & 117 only)

Test fuse as shown below.

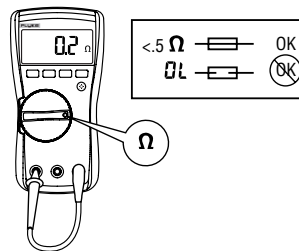

edy10f.eps

## True-rms Multimeters Maintenance

### Maintenance

Maintenance of the Meter consists of battery and fuse replacement, as well as case cleaning.

### Replacing the Battery and Fuse

#### ⚠⚠ Warning

To avoid shock, injury, or damage to the Meter:

- Remove test leads from the Meter before opening the case or battery door.
- Use **ONLY** a fuse with the amperage, interrupt voltage, and speed ratings specified.

To remove the battery door for battery replacement:

1. Remove the test leads from the Meter
2. Remove the battery door screw.
3. Use the finger recess to lift the door slightly.
4. Lift the door straight up to separate it from the case.

The battery fits inside the battery door, which is then inserted into the case, bottom edge first, until it is fully seated. Do not attempt to install the battery directly into the case.

5. Install and tighten battery door screw.

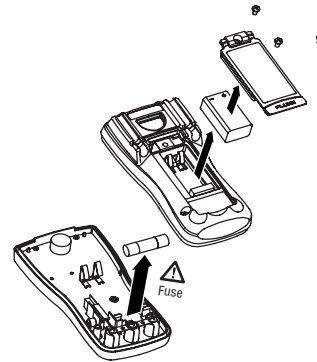

edy11f.eps

## **114, 115, and 117** *Users Manual*

---

To open the case for fuse replacement:

1. Remove the test leads from the Meter
2. Remove the Meter from its holster.
3. Remove two screws from the case bottom.
4. Separate the case bottom from the case top.
5. Remove the fuse from its holder and replace it with an 11 A, 1000 V, FAST fuse having a minimum interrupt rating of 17,000 A. Use only Fluke PN 803293.
6. To re-assemble the Meter, first attach the case bottom to the case top, then install the two screws. Finally, insert the Meter into its holster.

### **Cleaning**

Wipe the case with a damp cloth and mild detergent. **Do not use abrasives, isopropyl alcohol, or solvents to clean the case or lens/window.** Dirt or moisture in the terminals can affect readings.

**True-rms Multimeters**  
**General Specifications**

---

**General Specifications**

Accuracy is specified for 1 year after calibration, at operating temperatures of 18 °C to 28 °C, with relative humidity at 0 % to 90 %.

|  |  |
|--|--|
| <b>Maximum voltage between any terminal and earth ground</b> ..... | 600 V  |
| <b>Surge Protection</b> .....                                      | 6 kV peak per IEC 61010-1 600V CAT III, Pollution Degree 2   |
| <b>⚠ Fuse for A input (115 &amp; 117 only):</b> .....              | 11 A, 1000 V FAST 17 kA Fuse (Fluke PN 803293)   |
| <b>Display</b> .....   | Digital: 6,000 counts, updates 4/sec<br>Bar Graph: 33 segments, updates 32/sec   |
| <b>Temperature</b> .....   | Operating: -10 °C to + 50 °C<br>Storage: -40 °C to + 60 °C   |
| <b>Temperature Coefficient</b> .....                               | 0.1 x (specified accuracy)/°C (<18 °C or >28 °C)   |
| <b>Operating Altitude</b> .....                                    | 2,000 meters   |
| <b>Battery</b> .....   | 9 Volt Alkaline, NEDA 1604A / IEC 6LR61  |
| <b>Battery Life</b> .....  | Alkaline: 400 hours typical, without backlight   |
| <b>Safety Compliances</b> .....                                    | Complies with ANSI/ISA 82.02.01 (61010-1) 2004, CAN/CSA-C22.2 No 61010-1-04, UL 6101B (2003) and IEC/EN 61010-1 2 <sup>nd</sup> Edition for measurement Category III, 600 V, Pollution Degree 2, EMC EN61326-1 |

**114, 115, and 117**  
Users Manual

**Certifications** .....UL, CE, CSA, TÜV, , VDE

**IP Rating** (dust and water protection) ..... IP42

**Table 1. Accuracy Specifications**

| Function                              | Range    | Resolution | Accuracy<br>± ([% of Reading] + [Counts]) |                 | Model            |
|---------------------------------------|----------|------------|---|-----------------|------------------|
|                                       |          |            | DC, 45 to 500 Hz                          | 500 Hz to 1 kHz |                  |
| DC millivolts                         | 600.0 mV | 0.1 mV     | 0.5 % + 2                                 |                 | 114,<br>115, 117 |
| DC Volts                              | 6.000 V  | 0.001 V    | 0.5 % + 2                                 |                 | 114,<br>115, 117 |
|                                       | 60.00 V  | 0.01 V     |   |                 |                  |
|                                       |          |            | DC, 45 to 500 Hz                          | 500 Hz to 1 kHz |                  |
| Auto-V LoZ <sup>(1)</sup> True-rms    | 600.0 V  | 0.1 V      | 2.0 % + 3                                 | 4.0 % + 3       | 114, 117         |
|                                       |          |            | 45 to 500 Hz                              | 500 Hz to 1 kHz |                  |
| AC millivolts <sup>(1)</sup> True-rms | 600.0 mV | 0.1 mV     | 1.0 % + 3                                 | 2.0 % + 3       | 114,<br>115, 117 |
| AC Volts <sup>(1)</sup> True-rms      | 6.000 V  | 0.001 V    | 1.0 % + 3                                 |                 | 114,<br>115, 117 |
|                                       | 60.00 V  | 0.01 V     |   |                 |                  |
|                                       | 600.0 V  | 0.1 V      |   |                 |                  |

**True-rms Multimeters**  
General Specifications

**Table 1 Accuracy Specifications (cont.)**

| Function                              | Range          | Resolution | Accuracy<br>± ([% of Reading] + [Counts])   | Model            |
|---------------------------------------|----------------|------------|---|------------------|
| Continuity                            | 600 Ω          | 1 Ω        | Beeper on < 20 Ω, off > 250 Ω;<br>detects opens or shorts of<br>500 μs or longer. | 114, 115,<br>117 |
| Ohms                                  | 600.0 Ω        | 0.1 Ω      | 0.9 % + 2   | 114, 115,<br>117 |
|                                       | 6.000 kΩ       | 0.001 kΩ   | 0.9 % + 1   |                  |
|                                       | 60.00 kΩ       | 0.01 kΩ    | 0.9 % + 1   |                  |
|                                       | 600.0 kΩ       | 0.1 kΩ     | 0.9 % + 1   |                  |
|                                       | 6.000 MΩ       | 0.001 MΩ   | 0.9 % + 1   |                  |
|                                       | 40.00 MΩ       | 0.01 MΩ    | 5 % + 2   |                  |
| Diode test                            | 2.000 V        | 0.001 V    | 0.9 % + 2   | 115, 117         |
| Capacitance                           | 1000 nF        | 1 nF       | 1.9 % + 2   | 115, 117         |
|                                       | 10.00 μF       | 0.01 μF    | 1.9 % + 2   |                  |
|                                       | 100.0 μF       | 0.1 μF     | 1.9 % + 2   |                  |
|                                       | 9999 μF        | 1 μF       | 100 μF - 1000 μF: 1.9 % + 2<br>> 1000 μF: 5 % + 20                                |                  |
| Lo-Z Capacitance<br>(Power-up option) | 1 nF to 500 μF |            | 10% + 2 typical   | 115, 117         |

**114, 115, and 117**  
Users Manual

**Table 1 Accuracy Specifications (cont.)**

| Function  | Range  | Resolution                                 | Accuracy<br>± ([% of Reading] + [Counts]) | Model    |
|---|--|--|---|----------|
| AC Amps True-rms <sup>[1]</sup><br>(45 Hz to 500 Hz)  | 6.000 A<br>10.00 A <sup>[3]</sup><br>20 A for 30 seconds max.,<br>10 minutes rest min. | 0.001 A<br>0.01 A                          | 1.5 % + 3                                 | 115, 117 |
| DC Amps   | 6.000 A<br>10.00 A <sup>[3]</sup><br>20 A for 30 seconds max.,<br>10 minutes rest min. | 0.001 A<br>0.01 A                          | 1.0 % + 3                                 | 115, 117 |
| Hz (V or A input) <sup>[2]</sup>  | 99.99 Hz<br>999.9 Hz<br>9.999 kHz<br>50.00 kHz   | 0.01 Hz<br>0.1 Hz<br>0.001 kHz<br>0.01 kHz | 0.1 % + 2                                 | 115, 117 |
| Notes:<br>[1] All ac ranges except Auto-V LoZ are specified from 1 % to 100 % of range. Auto-V LoZ is specified from 0.0 V. Because inputs below 1 % of range are not specified, it is normal for this and other true-rms meters to display non-zero readings when the test leads are disconnected from a circuit or are shorted together. For volts, crest factor of ≤3 at 4000 counts, decreasing linearly to 1.5 at full scale. For amps, crest factor of ≤3. AC volts is ac-coupled. Auto-V LoZ, AC mV, and AC amps are dc-coupled.<br>[2] AC Volts Hz is ac-coupled and specified from 5 Hz to 50 kHz. AC Amps Hz is dc-coupled and specified from 45 Hz to 5 kHz.<br>[3] >10 A unspecified. |  |  |   |          |



**True-rms Multimeters**  
*General Specifications*

---

**Table 2. Input Characteristics**

| <b>Function</b> | <b>Input Impedance (Nominal)</b> | <b>Common Mode Rejection Ratio (1 kΩ Unbalanced)</b> |              | <b>Normal Mode Rejection</b> |
|-----------------|----------------------------------|--|--------------|------------------------------|
| Volts AC        | >5 MΩ <100 pF                    | >60 dB at dc, 50 or 60 Hz                            |              |                              |
| Volts DC        | >10 MΩ <100 pF                   | >100 dB at dc, 50 or 60 Hz                           |              | >60 dB at 50 or 60 Hz        |
| Auto-V LoZ      | ~3 kΩ <500 pF                    | >60 dB at dc, 50 or 60 Hz                            |              |                              |
|                 | <b>Open Circuit Test Voltage</b> | <b>Full Scale Voltage</b>                            |              | <b>Short Circuit Current</b> |
| Ohms            | <2.7 V dc                        | <b>To 6.0 MΩ</b>                                     | <b>40 MΩ</b> | <350 μA                      |
|                 |                                  | <0.7 V dc  | <0.9 V dc    |                              |
| Diode Test      | <2.7 V dc                        | 2.000 V dc   |              | <1.2 mA                      |