

Fyrite® **INTECH**®

Combustion Gas Analyzer Configuration and Operation Manual



Instruction 0024-9486
Revision 3
October 2014

Product Leadership • Training • Service • Reliability

WARRANTY POLICY

Bacharach, Inc. warrants to Buyer that at the time of delivery this product will be free from defects in material and manufacture and will conform substantially to Bacharach Inc.'s applicable specifications. Bacharach's liability and buyer's remedy under this warranty are limited to the repair or replacement, at Bacharach's option, of this product or parts thereof returned to seller at the factory of manufacture and shown to Bacharach Inc.'s reasonable satisfaction to have been defective; provided that written notice of the defect shall have been given by buyer to Bacharach Inc. within two (2) years after the date of delivery on Product, CO sensor, and O₂ sensor.

Bacharach, Inc. warrants to buyer that it will convey good title to this product. Bacharach's liability and buyer's remedy under this warranty of title are limited to the removal of any title defects or, at the election of Bacharach, to the replacement of this product or parts thereof that are defective in title.

THE FOREGOING WARRANTIES ARE EXCLUSIVE AND ARE GIVEN AND ACCEPTED IN LIEU OF (I) ANY AND ALL OTHER WARRANTIES, EXPRESS OR IMPLIED, INCLUDING WITHOUT LIMITATION THE IMPLIED WARRANTIES OF MERCHANTABILITY AND FITNESS FOR A PARTICULAR PURPOSE: AND (II) ANY OBLIGATION, LIABILITY, RIGHT, CLAIM OR REMEDY IN CONTRACT OR TORT, WHETHER OR NOT ARISING FROM BACHARACH'S NEGLIGENCE, ACTUAL OR IMPLIED. The remedies of the buyer shall be limited to those provided herein to the exclusion of any and all other remedies including, without limitation incidental or consequential damages. No agreement varying or extending the foregoing warranties, remedies or this limitation will be binding upon Bacharach, Inc. unless in writing, signed by a duly authorized officer of Bacharach.

**Register your warranty by visiting
www.MyBacharach.com**

NOTICE

Product improvements and enhancements are continuous; therefore the specifications and information contained in this document may change without notice.

Bacharach, Inc. shall not be liable for errors contained herein or for incidental or consequential damages in connection with the furnishing, performance, or use of this material.

No part of this document may be photocopied, reproduced, or translated to another language without the prior written consent of Bacharach, Inc.

Copyright © 2014, Bacharach, Inc., all rights reserved.

BACHARACH, Fyrite, InTech, and B-SMART are registered trademarks of Bacharach, Inc. All other trademarks, trade names, service marks and logos referenced herein belong to their respective companies.

Table of Contents

- Section 1. Overview 1
 - 1.1. Introduction 1
 - 1.2. Conventions..... 1
 - 1.3. Safety..... 1
 - 1.4. Product Overview..... 3
 - 1.5. North American (NA) vs. Siebert (S) Combustion Equations 3
 - 1.6. Components 5
 - 1.7. Features..... 7
 - 1.8. Combustion Test Process Overview 8
 - 1.9. Fyrite® InTech® Sales Combinations 9
 - 1.10. Specifications..... 11

- Section 2. Setup..... 13
 - 2.1. Connecting the Probe and Thermocouple 13
 - 2.2. Front Panel Buttons..... 14
 - 2.3. Power Options..... 15
 - 2.4. Turning On the Fyrite® InTech® 16

- Section 3. Configuration 17
 - 3.1. Menu Structure Overview 17
 - 3.2. The Warm-up Sequence..... 17
 - 3.3. Main Menu 18
 - 3.4. Select Fuel Menu..... 19
 - 3.5. Ambient CO Menu (Siebert Only)..... 20
 - 3.6. Memory Options Menu 22
 - 3.7. Setup Menu..... 24
 - 3.8. Calibration Menu..... 35
 - 3.9. Diagnostics Menu 36
 - 3.10. Status Menu 38

- Section 4. Operation..... 39
 - 4.1. Prerequisites 39
 - 4.2. Sampling Point Examples 39
 - 4.3. Combustion Testing Process 42
 - 4.4. The RUN Screen..... 43
 - 4.5. Printing Using the Optional IrDA Printer 44
 - 4.6. Taking Ambient CO Measurements 47

4.7. PC Interface and Fyrite® User Software..... 48

Section 5. Calibration and Maintenance 49

5.1. Serviceability 49

5.2. Cleaning the Probe 49

 5.2.1. Equipment Required 50

 5.2.2. Procedure 50

5.3. Water Trap and Filter Replacement 51

5.4. O₂ and/or CO Sensor Replacement 52

 5.4.1. Accessing the Sensors 52

 5.4.2. Material Required (As Needed) 52

 5.4.3. O₂ Sensor Replacement Procedure..... 53

 5.4.4. CO Sensor Replacement Procedure 53

 5.4.5. B-SMART® CO Sensor Replacement..... 54

5.5. T-Stack Calibration 55

 5.5.1. Materials Required 55

 5.5.2. T-Stack Calibration Procedure 55

5.6. CO Sensor Calibration..... 57

 5.6.1. Materials Required 57

 5.6.2. CO Manual Zero Procedure 57

 5.6.3. CO Sensor Span Procedure 58

5.7. T-Ref Sensor Calibration..... 59

Section 6. Troubleshooting..... 60

6.1. Error and Warning Messages 60

6.2. Replacement Parts 61

6.3. Accessories 62

6.4. Instrument Identification 63

6.5. Service Centers..... 63

Declaration of Conformity 65



Section 1. Overview

1.1. Introduction

Thank you for investing in a Bacharach Fyrite® InTech® combustion analyzer. To assure proper use and operator safety, please read the contents of this manual for important information on the operation and maintenance of the analyzer.

1.2. Conventions



WARNING: A warning statement denotes a potential hazard associated with the use of this equipment. Failure to follow this information could result in serious personal injury or death.



CAUTION: A caution statement indicates a potentially hazardous situation which, if not avoided, may result in minor or moderate injury. Caution statements may also be used to alert against unsafe practices.



IMPORTANT: An important statement provides emphasis of an important feature, operation, etc. Failure to follow this information could void your warranty, result in improper operation, or cause equipment damage.



NOTE: A note statement provides emphasis of a feature, operation, practice, etc.

1.3. Safety



WARNING: This analyzer is not intended to be used as a safety device.



WARNING: When testing an appliance, a full visual inspection of the appliance should be performed to ensure its safe operation.



CAUTION: This analyzer is not intended to be used on a continuous basis.



CAUTION: Do not store instrument or its sensors with solvents or products that contain solvents.



CAUTION: Except for sensor and battery replacement, this analyzer should only be opened and/or serviced by authorized Bacharach personnel. Failure to comply may void the warranty.



HAZARDOUS AREA WARNING: This instrument has not been designed to be intrinsically safe for use in areas classified as hazardous locations. For your safety, **DO NOT** use it in hazardous (classified) locations.



CAUTION: Do not use flammable or combustible substances (like carburetor fluid used for cleaning the probe) near an open flame.

CAUTION: When the instrument is used in an inefficient oil-fueled appliance where there is a high emission of soot, the probe's sample filter may become clogged. Before every use check the filter to confirm it is clean or replace it with a new filter.

To prevent soot intake and a clogged filter, a smoke test should be performed before operating under such conditions. This ensures that the furnace or boiler is burning at a level appropriate for the use of this instrument.



When the CO₂ level exceeds the allowable threshold, a warning will prompt the user to consider performing a smoke test. This screen is cleared by pressing the ENTER button. Once the warning is cleared, it will not be displayed again for that particular test. If a new test is started (by pressing the HOLD button), the warning will be displayed again if the limit has been exceeded.

1.4. Product Overview

The Fyrite® InTech® is a portable hand-held combustion analyzer for use in residential and light commercial applications. It is intended to be used by:

- HVAC contractors
- home inspectors
- maintenance personnel
- energy auditors

to conduct combustion efficiency analysis on residential and light commercial furnaces and appliances in the worldwide market.

The instrument is supplied with all of the following components:

- probe and hose assembly
- four disposable “AA” alkaline batteries
- soft or hard carrying case (depending on model)
- factory-calibrated and installed sensor(s) as ordered

and, depending on the model and kit, some or all of the following:

- rubber boot
- spare filters
- Fyrite® User Software (FUS)
- USB cable (type A to mini B)
- Infrared Data Association (IrDA) printer with four disposable “AA” alkaline batteries
- printer paper

1.5. North American (NA) vs. Siegert (S) Combustion Equations

Though the combustion *process* is fairly standardized across the globe, a combustion analyzer intended for worldwide use demands a degree of flexibility for a few regional preferences. The Fyrite® InTech® provides a North American configuration and a Siegert configuration (see page 32) to address these and other needs, which are contrasted below.



NOTE: Detailed differences between North American and Siegert configurations are noted where appropriate in this manual.

Feature	North American (NA) versus Siegert (S) Configurations																												
Countries	<p>Typical North American (NA) Users</p> <ul style="list-style-type: none"> Asia Australia Latin America North America South America 	<p>Typical Siegert (S) Users</p> <ul style="list-style-type: none"> Belgium Denmark France Germany Italy Netherlands Poland Spain United Kingdom 																											
Heating Values	For combustion calculations, Siegert uses the fuel's <i>lower</i> heating value; NA uses the <i>higher</i> value.																												
Fuels	Different fuel sets and composition (p 19)																												
Different RUN Parameters	EFF (NA) vs. Stack loss and ETA (S) Excess Air (NA) vs. Lambda (S) (Lambda is similar to excess air)																												
Extra Siegert Parameters	CO/CO ₂ ratio, boiler temperature, smoke number, and oil derivative are displayed for Siegert only.																												
CO ₂ Max	Siegert users can set a CO ₂ max number for the fuel.																												
Print Average Feature	There is a print average feature for Siegert.																												
NO _x Filter	A NO _x filter is included in-line on the tubing of the gas sample probe of Siegert units.																												
Languages	3 languages for North American (NA) configuration. 8 languages for Siegert (S) configuration.																												
<table border="1" style="width: 100%; text-align: center;"> <thead> <tr> <th></th> <th>English</th> <th>French</th> <th>Spanish</th> <th>German</th> <th>Italian</th> <th>Danish</th> <th>Polish</th> <th>Dutch</th> </tr> </thead> <tbody> <tr> <td>NA</td> <td>•</td> <td>•</td> <td>•</td> <td></td> <td></td> <td></td> <td></td> <td></td> </tr> <tr> <td>S</td> <td>•</td> <td>•</td> <td>•</td> <td>•</td> <td>•</td> <td>•</td> <td>•</td> <td>•</td> </tr> </tbody> </table>				English	French	Spanish	German	Italian	Danish	Polish	Dutch	NA	•	•	•						S	•	•	•	•	•	•	•	•
	English	French	Spanish	German	Italian	Danish	Polish	Dutch																					
NA	•	•	•																										
S	•	•	•	•	•	•	•	•																					

1.6. Components

- 1 Monochrome Display (LCD) with Backlight
- 2 Function Keys (F1, F2, and F3)
 - Context sensitive
 - Functions shown at bottom of display
- 3, 4 Up and Down Arrow Keys
 - Scroll up/down through a list
 - Increase/decrease alphanumeric values
- 5, 6 Left and Right Arrow Keys
 - Scroll left/right through a field
 - Jump to top/bottom of list
- 7 Enter Key
 - Choose highlighted item
 - Accept value/characters
- 8 Escape Key
 - Cancel most operations and display previous screen
- 9 Power/Backlight Key

• Press & release	Power ON
• Press & release	Toggle backlight ON/OFF
• Press & hold (2 secs)	Begin power OFF sequence
- 10 Run/Hold Key

• While in HOLD	Turn on pump, display RUN screen, and begin combustion test.
• While in RUN	Turn off pump, display HOLD screen and last set of combustion data.
• In most menus	Display HOLD screen.
• During power down	Return display to HOLD screen (cancel power down).



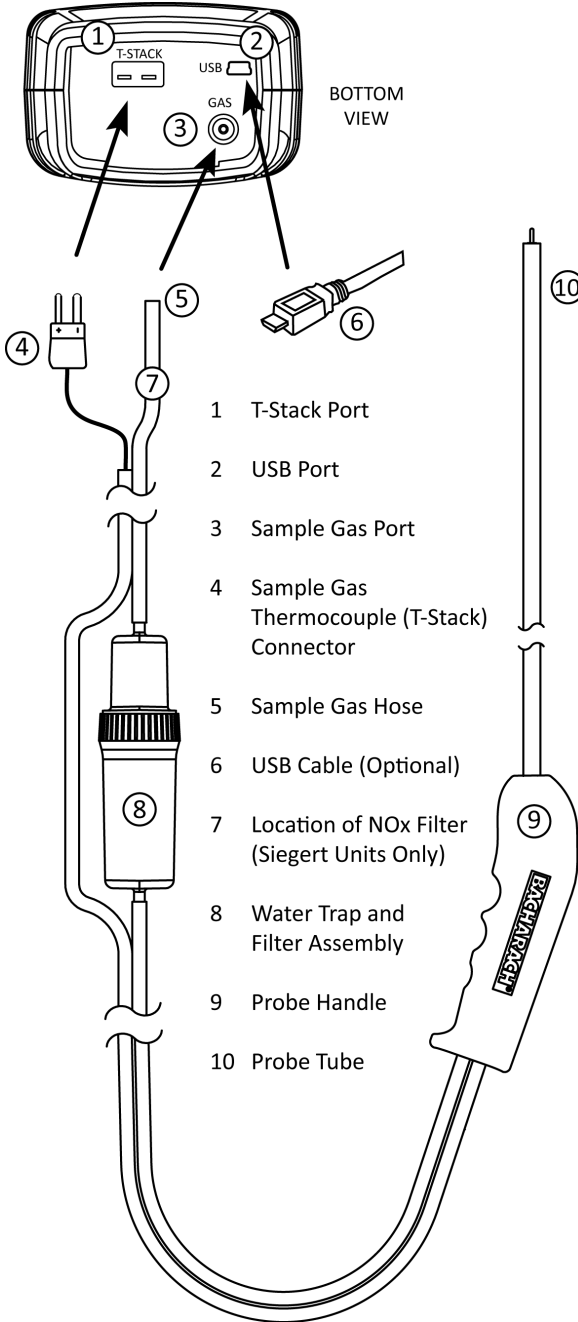

1.7. Features

- Sensors (pp 52, 61)
 - Field-replaceable electrochemical sensors (O₂ and B-SMART® CO)
 - Flue gas temperature measurement using a Type K thermocouple
- Fuel codes (p 19)
 - Six available fuels (in North American configuration)
 - Ten available fuels (in Siegert configuration)
- Power (pp 11, 15)
 - 4 AA alkaline batteries (included)
 - 4 AA lithium batteries
 - 4 AA rechargeable batteries (externally charged)
 - Low battery warning
- Testing Features
 - Complete test results (10 sets) can be stored, recalled, displayed, and printed (p 22).
 - Time and date stamping of test results
 - Secure calibration function (password protected) (p 35)
 - Auto power-off feature with sensor purge feature (p 30)
 - Status and diagnostic menus (p 36)
 - Manual entry of values (Siegert only) (pp 25, 26)
 - Ambient CO (Siegert Only) (p 47)
- User Customizations
 - Combustion Air Temperature (T-Air) source selection (p 34)
 - North American and Siegert combustion calculations (pp 32, 44)
 - Multi-language interface (p 29)
 - Auto/Manual zero functions for the CO sensor (p 31)
 - Customized user information (3 lines of 20 characters) (p 45)
 - Customized logo on printouts (192 x 384 pixels) (p 47)
 - Temperature unit selection (p 24)
 - CO sensor protection feature (p 33)
- Hardware (p 5)
 - Probe/hose assembly for gas transport and temperature input
 - Sample pump to provide gas sample delivery
 - Backlit monochrome graphic LCD
 - Hard or soft carrying case
 - USB 2.0 (mini-B connection) for PC interface and communications
- PC Interface (p 48)
 - USB cable (Type A to Mini B)
 - Fyrite® User Software (FUS) (Windows compatible)
 - Updates and instrument configuration

1.8. Combustion Test Process Overview

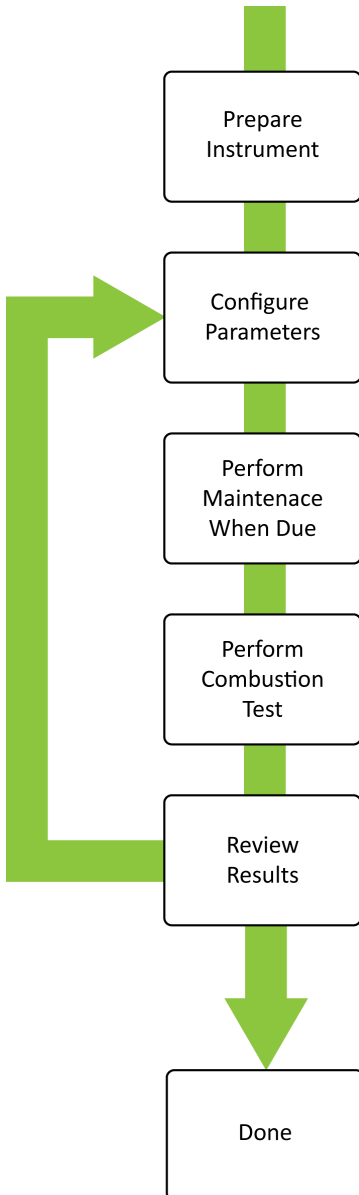

FUNCTION.....	PAGES
Connect Probe	13
Turn On Instrument	14, 15, 16
Verify Power	15
Zero Instrument (Auto/Manual)	17, 31, 57
Use Menu System	17
Set System Parameters	19, 24, 34
Set Combustion Test Parameters	19
Replace Sensor(s) as Needed	36, 52
Calibrate as Needed	35, 57
Replace Batteries as Needed.....	15
Filter Replacement	51
Place Probe in Sampling Point.....	39
Collect Data (RUN Button)	43
Save Data as Needed (F3)	14, 43
Stop Test (HOLD Button)	14, 43
Print Data as Needed (F1)	14, 43, 44
Save Data (F3)	14, 43
Print Data (F1) (Option).....	14, 43, 44
Review All Combustion Data	14, 43, 44
Adjust Combustion Equipment As Needed	
Save Data (F3)	14, 43
Purge Instrument	30, 42
Disconnect Probe	42
Turn Off Instrument	14, 42
Clean and Store.....	42



NOTE: The North American (NA) configuration of Fyrite® InTech® computes and displays the calculations as long as the measured oxygen is not above 16% O₂ and the stack temperature is not above 650° C (1200° F). The Siegert configuration of the Fyrite® InTech® computes and displays the calculations as long as the measured oxygen is not above 18.8% O₂ and the stack temperature is not above 650° C (1200° F).

1.9. Fyrite® InTech® Sales Combinations

Fuel Equations	North American (NA)			Siegert (S)	
Final Assembly	0024-7340	0024-7341		0024-7342	
Kit Type	O ₂ Only	Basic	Reporting	Basic	Reporting
Sales Kit P/N	0024-8510	0024-8511	0024-8512	0024-8513	0024-8514
Probe	X	X	X	X	X
Batteries	X	X	X	X	X
T-Stack	X	X	X	X	X
Manual	X	X	X	X	X
O ₂	X	X	X	X	X
CO		X	X	X	X
Fuels	6	6	6	10	10
Soft Case	X	X		X	
Hard Case			X		X
Printer			X		X
Boot			X		X
PC Software			X		X
USB Cable			X		X
Spare Filters			X		X
NO _x Filter				X	X



1.10. Specifications

Specification	Description		
Temperature	Storage:	-20° to 50° C (-4° to 122° F) 0° to 20° C (32° to 68° F) optimal	
	Operation:	-5° to 45° C (23° to 113° F)	
	Reference:	20° ± 2° C (68° ± 4° F)	
Humidity	Storage:	15 to 90% RH, non-condensing	
	Operation:	15 to 95% RH, non-condensing	
	Reference:	45 ± 10% RH, non-condensing	
Pressure	1 atmosphere ± 10%		
Weight	16 ounces (454 g) with batteries		
Dimensions	8.0" x 3.6" x 2.3" (20.3 cm x 9.1 cm x 5.8 cm) (H x W x D)		
Warm-up Time	Minimum = 30 seconds; Maximum = 60 seconds		
Gas Sample Flow Rate	300 to 700 cc/min		
Sensors	O ₂	Electrochemical	(P/N: 0024-0788)
	CO	Electrochemical	(P/N: 0024-7265)
	Temp (Stack)	K-Type thermocouple	
Product Approvals and Regulatory Compliance	EN50270:	(CE Mark) EMC tested in accordance with European Directive 2004/108/EC .	
	EN50379:	Standard for portable electrical apparatus designed to measure combustion flue gas parameters of heating appliances (Siebert only) Parts 1 and 3.	
	RoHS Compliance		
Case Construction	High impact ABS plastic with co-molded rubber. Protective rubber boot with molded-in magnets.		
Display	Monochrome with backlight		
USB Connector	Mini B (USB 2.0)		
Memory	10 locations for storing test results		
IrDA Port	Protocol:	IrDA-SIR	Data Bits: 8 Stop Bits: 1
	Baud Rate:	9600	Parity: None
Power Supply Options	Batteries (4 AA)	Type:	Disposable Alkaline (Included)
		Duration:	15 hours min, continuous max draw
		Type:	Disposable Lithium
	Duration:	20 hours, continuous max draw	
	Type:	Rechargeable	
	Duration:	8 hours, continuous max draw	

Measure-ment	Range	Resolution	Accuracy	Response Time (T90)
O ₂	0 to 20.9 %	0.1% O ₂	±0.3% O ₂ (on flue gas)	< 20 sec
CO	0 to 2000 ppm	1 ppm	±10 ppm (0 to 200) ±5% reading (201 to 2000)	< 40 sec
Stack Temp	-20° to 650° C (-4° to 1202° F)	1° C (1° F)	±2° C (0° to 124° C) ±3° C (125° to 249° C) ±4° C (250° to 400° C)	< 50 sec

Calculation	Calculation Range	Reso-lution	Version	
			NA	Siegert
Efficiency (HHV)	0.1 to 100 %	0.1%	X	X
ETA (LHV)	0 to 115%	0.1%		X
Excess Air	1 to 250 %	1%	X	
Stack Loss	0.1 to 100 %	0.1 %		X
Lambda	1 to 9.55	0.01		X
CO ₂ (dry basis)	0.1 to a fuel-dependent max in %	0.1 %	X	X
CO Ref to O ₂	0 to 9999 ppm	1 ppm	X	X
CO/CO ₂ Ratio	0.0001 to fuel-dependent max	0.0001		X



Section 2. Setup

2.1. Connecting the Probe and Thermocouple

A rigid stainless steel probe with handle is connected to a flexible hose with an integral water-trap/filter used to draw a gas sample into the analyzer from the room, grilles, diffusers, and furnace flues.





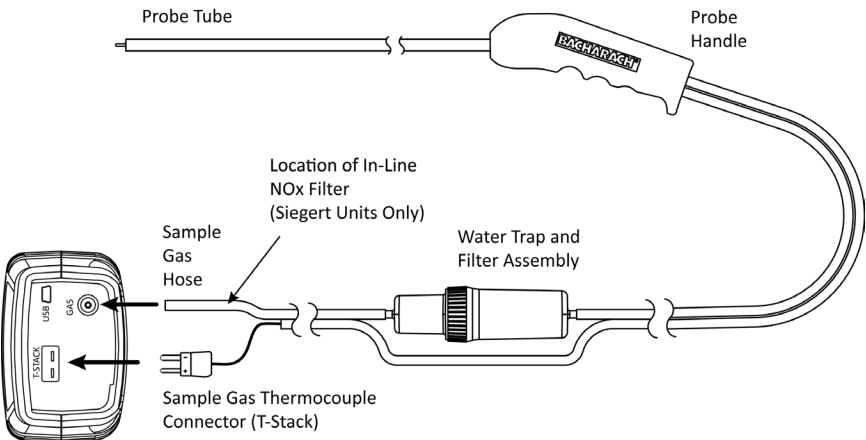

1. Inspect the flue-gas hose for cracks. If a hose is defective, replace the entire probe assembly.
2. Before using the analyzer, check that the water trap/filter is clean and dry. If necessary, dry out the trap and replace the filter element.
3. Push the probe's "sample gas" tubing onto the GAS inlet connector.
4. Push the probe's thermocouple into the T-STACK connector on the instrument noting the orientation.



IMPORTANT: The T-STACK connector tabs are keyed to fit into the connector in only one orientation. **DO NOT** force the thermocouple connector tabs into the T-STACK connector.



2.2. Front Panel Buttons

Button	Description
	<ul style="list-style-type: none"> • Powers the analyzer ON and OFF. Hold this button down for at least 2 seconds to turn the power OFF. • Toggles the backlight ON and OFF while the analyzer is turned ON.
	<ul style="list-style-type: none"> • UP (▲), DOWN (▼), LEFT (◀), and RIGHT (▶) arrows are context-specific navigation buttons for the menus. • UP (▲) and DOWN (▼) arrow buttons scroll to menu options that are hidden from view (when a side scroll bar is displayed indicating additional information). • UP (▲) and DOWN (▼) arrow buttons cause the displayed value to increase or decrease accordingly. • LEFT (◀) and RIGHT (▶) arrow buttons jump to the top and bottom of lists, respectively. • LEFT (◀) and RIGHT (▶) arrow buttons position the active cursor on specific elements of a value to be changed.
	<ul style="list-style-type: none"> • The ENTER button. Performs the action selected.
	<ul style="list-style-type: none"> • While in the HOLD screen, turns the sample pump on, displays the RUN screen, and begins a combustion test. • While in the RUN screen, turns the sample pump off, displays the HOLD screen and the last set of combustion data. • Displays the HOLD screen while pressing it from most menus. • Returns the display to the HOLD screen while pressing it during the shutdown sequence.
	<ul style="list-style-type: none"> • The ESC button cancels most operations and displays the previous screen.
	<ul style="list-style-type: none"> • Pressing function keys accepts the corresponding function defined above that key at the bottom of the display (for example, PRINT, SAVE, MENU, etc.).

2.3. Power Options

You use the PWR button to turn on the Fyrite® InTech®. Power options include:

- Disposable AA alkaline batteries (included)
- Disposable AA lithium (Li) batteries
- Externally charged rechargeable NiMH batteries.

Check the Fyrite® InTech® for sufficient power prior to each use. Replace the batteries if the low (or replace) battery symbol appears in the upper right corner of the Fyrite® InTech® screen.

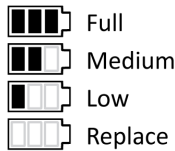

Batteries (4 AA, Fresh or Fully Charged)	Estimated Life Span in Hours (Continuous, Pump On)
Alkaline (disposable)	15 hours
Lithium (disposable)	20 hours
Rechargeable	8 hours

Replace batteries as follows.

1. Remove the battery cover from the back of analyzer.
2. If old batteries are installed, remove them and properly discard them.
3. Observing the polarity markings inside the battery compartment, install four 'AA' disposable (alkaline or lithium) batteries or four fully-charged (externally charged) AA rechargeable NiMH batteries.
4. Replace the battery cover.



NOTE: The Fyrite® InTech® does NOT charge rechargeable batteries.

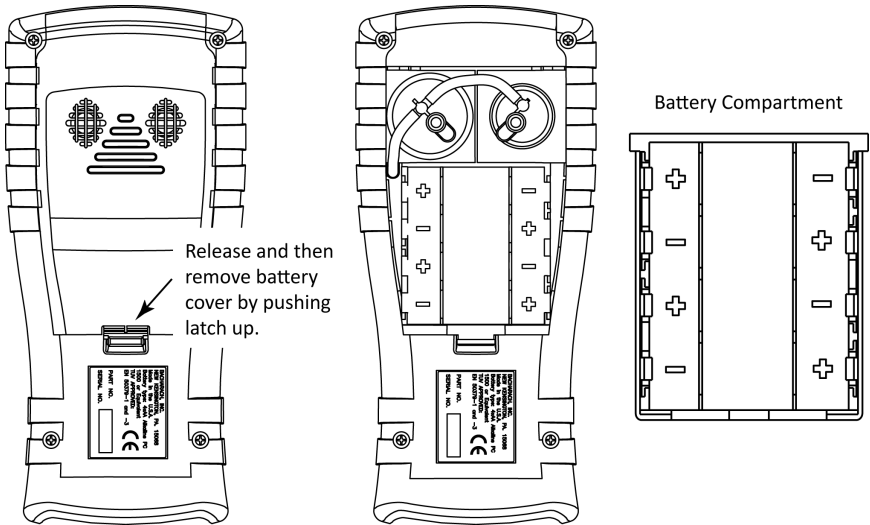

NOTE: A Set Clock error message will be displayed if the instrument is without power for an extended period of time.

2.4. Turning On the Fyrite® InTech®

To turn on the Fyrite® InTech®, press the PWR button.



NOTE: After turning on the Fyrite® InTech®, it performs a warm-up procedure which includes an auto-zero procedure for the sensors (see pages 17 and 31). For this reason, be sure to turn on the Fyrite® InTech® in a clean air environment.



Section 3. Configuration



3.1. Menu Structure Overview



NOTE: The Fyrite[®] InTech[®] may be configured to use either North American combustion equations or Siegert combustion equations (see page 32). As a result, several parameters are unique to each configuration. This section shows a mix of screens that have been configured for North American combustion equations as well as Siegert combustion equations. Depending on how you have configured your instrument, your screens may vary slightly from those pictured in this section.







Menus and the items contained within them are described in a top-down fashion, starting from the startup screens and working sequentially through the menus and menu items.

3.2. The Warm-up Sequence

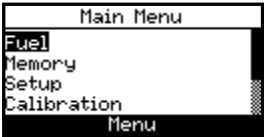
Boot Screens	Description
	<p>Splash screen shows the Bacharach logo with version, model number, and serial number information. This screen is displayed for approximately 3 seconds.</p>
	<p>A warm-up screen is displayed during which the instrument is purged and initialized. A countdown timer is displayed with the current zero setting for the CO sensor (Auto-Zero or Manual Zero) (see page 31 and page 57).</p>
	<p>If any errors are detected during warm-up, the corresponding error messages are displayed, after which the user presses F2 to go to the Menu, or presses RUN/HOLD to go to the Hold screen. (See page 60 for a list of error messages.)</p>

3.3. Main Menu



Display the Main Menu by pressing the F2 key. Note that features and items displayed in menus are model dependent. Your screens may vary.

Main Menu	Function
 <p>Main Menu Fuel Memory Setup Calibration Menu</p>	<p>Access the Select Fuel Menu (see page 19)</p> <ul style="list-style-type: none"> Select combustion fuel
 <p>Main Menu Fuel Ambient CO Test Memory Setup Menu</p>	<p>Access the Ambient CO Test Menu (Sievert Only) (see page 20)</p> <ul style="list-style-type: none"> Initiate a 15-minute CO test Get reading every minute and max CO reading Print/Save 16 readings and max CO
 <p>Main Menu Fuel Memory Setup Calibration Menu</p>	<p>Access the Memory Options Menu (see page 22).</p> <ul style="list-style-type: none"> Access previously saved test results Delete all previously saved test results
 <p>Main Menu Fuel Memory Setup Calibration Menu</p>	<p>Access the Setup Menu (see page 24).</p> <ul style="list-style-type: none"> Edit/view instrument preference Edit/view system parameters Edit/view combustion test parameters
 <p>Main Menu Fuel Memory Setup Calibration Menu</p>	<p>Access the Calibration Password Screen and the Calibration Menu (see page 35).</p> <ul style="list-style-type: none"> Calibrate sensors
 <p>Main Menu Setup Calibration Diagnostics Status Menu</p>	<p>Access the Diagnostics Menu (see page 36).</p> <ul style="list-style-type: none"> View “run” meters and system diagnostic values Check O₂ sensor life Fresh air diagnostics
 <p>Main Menu Setup Calibration Diagnostics Status Menu</p>	<p>Access the Device Status Menu (see page 38).</p> <ul style="list-style-type: none"> Access the software date, model number, serial number, and version information

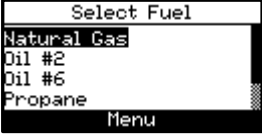
3.4. Select Fuel Menu



Select Fuel	Function																						
	<p>Select the combustion fuel from the fuel list. Use the UP (▲) and DOWN (▼) arrow keys to highlight the desired fuel and use the ENTER key to select.</p> <table border="1"> <thead> <tr> <th>NA Fuel List</th> <th>Siebert Fuel List</th> </tr> </thead> <tbody> <tr> <td>Natural Gas</td> <td>Natural Gas</td> </tr> <tr> <td>Oil 2</td> <td>KOKS</td> </tr> <tr> <td>Oil 6</td> <td>LEG</td> </tr> <tr> <td>Propane</td> <td>Propane</td> </tr> <tr> <td>Kerosene</td> <td>Oil 2</td> </tr> <tr> <td>B5</td> <td>Oil 6</td> </tr> <tr> <td></td> <td>Coal</td> </tr> <tr> <td></td> <td>Biofuel</td> </tr> <tr> <td></td> <td>LPG</td> </tr> <tr> <td></td> <td>Butane</td> </tr> </tbody> </table>	NA Fuel List	Siebert Fuel List	Natural Gas	Natural Gas	Oil 2	KOKS	Oil 6	LEG	Propane	Propane	Kerosene	Oil 2	B5	Oil 6		Coal		Biofuel		LPG		Butane
NA Fuel List	Siebert Fuel List																						
Natural Gas	Natural Gas																						
Oil 2	KOKS																						
Oil 6	LEG																						
Propane	Propane																						
Kerosene	Oil 2																						
B5	Oil 6																						
	Coal																						
	Biofuel																						
	LPG																						
	Butane																						

3.5. Ambient CO Menu (Sievert Only)

Ambient CO	Function						
	<p>Access the Ambient CO Menu (Sievert only).</p> <p>When initiated, the Ambient CO feature monitors CO values continuously and captures a reading every minute for 15 minutes (a total of 16 readings from t_0 to t_{15}).</p> <p>Press ENTER to initiate the Ambient CO test. This begins a 15-minute test cycle, during which a status screen is displayed. It shows the starting ambient CO value, the current CO value, and the elapsed time into the test.</p> <div style="text-align: center; margin: 10px 0;">  </div> <table border="1" style="width: 100%; border-collapse: collapse; margin: 10px 0;"> <thead> <tr> <th style="width: 50%;">Ambient CO</th> <th style="width: 50%;">Ambient CO</th> </tr> </thead> <tbody> <tr> <td style="font-family: monospace;"> Start: 0 ppm Current: 0 ppm Time: 00:03 </td> <td style="font-family: monospace;"> Start: 0 ppm Current: 0 ppm Time: 13:40 </td> </tr> <tr style="background-color: black; color: white;"> <td style="text-align: center;">Cancel</td> <td style="text-align: center;">Cancel</td> </tr> </tbody> </table>	Ambient CO	Ambient CO	Start: 0 ppm Current: 0 ppm Time: 00:03	Start: 0 ppm Current: 0 ppm Time: 13:40	Cancel	Cancel
Ambient CO	Ambient CO						
Start: 0 ppm Current: 0 ppm Time: 00:03	Start: 0 ppm Current: 0 ppm Time: 13:40						
Cancel	Cancel						
<div style="display: flex; align-items: center; justify-content: center;"> <p>NOTE: Press the F2 key to cancel a test in progress.</p> </div>							
<p>After the test is complete, the Ambient CO Summary screen is displayed. This is a scrollable window that shows the 16 CO “snapshot” readings, as well as the maximum CO reading that was sampled during the entire test.</p>							
<div style="display: flex; align-items: center; justify-content: center;"> <p>NOTE: The Max CO Reading is the highest sampled CO reading – even if the reading was taken in between one of the sample “snapshot” readings.</p> </div>							





Ambient CO	Function																													
<div data-bbox="416 201 944 337" data-label="Table"> <table border="1"> <thead> <tr> <th colspan="2">Ambient CO Summary</th> <th colspan="2">Ambient CO Summary</th> </tr> <tr> <th>Time(min)</th> <th>CO(ppm)</th> <th></th> <th></th> </tr> </thead> <tbody> <tr> <td>0</td> <td>0</td> <td>13</td> <td>0</td> </tr> <tr> <td>1</td> <td>0</td> <td>14</td> <td>0</td> </tr> <tr> <td>2</td> <td>0</td> <td>15</td> <td>0</td> </tr> <tr> <td colspan="2"></td> <td>Max CO</td> <td>0</td> </tr> <tr> <td colspan="2">Print Menu Save</td> <td colspan="2">Print Menu Save</td> </tr> </tbody> </table> </div> <p data-bbox="409 365 957 451">The test results can be printed by pressing F1 and saved to memory (with a time and date stamp) by pressing F3. Press F2 to return to the menu.</p> <hr/> <div data-bbox="441 495 484 576" data-label="Image"> </div> <p data-bbox="510 495 941 576">NOTE: If the ambient CO results are saved to memory, they are not included as part of the Print Average feature.</p> <hr/> <div data-bbox="441 625 484 706" data-label="Image"> </div> <p data-bbox="510 641 941 698">NOTE: Any over-range CO values (e.g., CO = 2000 ppm) are displayed as “xxx”.</p> <hr/>	Ambient CO Summary		Ambient CO Summary		Time(min)	CO(ppm)			0	0	13	0	1	0	14	0	2	0	15	0			Max CO	0	Print Menu Save		Print Menu Save			
	Ambient CO Summary		Ambient CO Summary																											
	Time(min)	CO(ppm)																												
0	0	13	0																											
1	0	14	0																											
2	0	15	0																											
		Max CO	0																											
Print Menu Save		Print Menu Save																												

3.6. Memory Options Menu





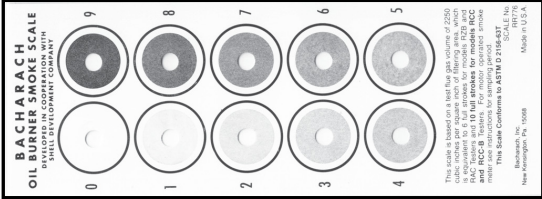

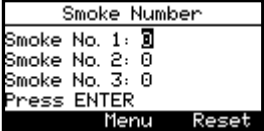
Memory Options	Function
	<p>Access the Memory Directory.</p> <p>This directory contains a numbered list of saved combustion tests (starting at "1"). "NO DATA" is displayed if no tests were saved since the last time that memory was cleared.</p> <div style="display: flex; justify-content: space-around;"> <div style="border: 1px solid black; padding: 2px;"> <p style="text-align: center;">Memory Directory</p> <p>1 02/24/08 02:01:43</p> <p>2 02/24/08 02:01:49</p> <p>3 02/24/08 02:01:54</p> <p>4 02/24/08 02:01:57</p> <p style="text-align: center;">PAGE- Menu PAGE+</p> </div> <div style="border: 1px solid black; padding: 2px;"> <p style="text-align: center;">Memory Directory</p> <p>No Data</p> <p style="text-align: center;">PAGE- Menu PAGE+</p> </div> </div> <p>To view saved data, use the UP (▲) and DOWN (▼) arrow keys to highlight the desired test from the list.</p> <div style="border: 1px solid black; padding: 2px; margin: 10px auto; width: fit-content;"> <p style="text-align: center;">Memory Directory</p> <p>1 02/24/08 02:01:43</p> <p>2 02/24/08 02:01:49</p> <p style="background-color: black; color: white;">3 02/24/08 02:01:54</p> <p>4 02/24/08 02:01:57</p> <p style="text-align: center;">PAGE- Menu PAGE+</p> </div> <p>Press the ENTER button to display the saved data.</p> <div style="display: flex; justify-content: space-around;"> <div style="border: 1px solid black; padding: 2px; width: 45%;"> <p>Mem: 3 Nat Gas</p> <p>O₂ 20.9 %</p> <p>CO 0 ppm</p> <p>CO(O) *** ppm</p> <p>Eff *** %</p> <p style="text-align: center;">Print Menu</p> </div> <div style="border: 1px solid black; padding: 2px; width: 45%;"> <p>Mem: 3 Nat Gas</p> <p>Eff *** %</p> <p>CO 0 ppm</p> <p>T-STK *** °F</p> <p>T-Air 70.2 °F</p> <p style="text-align: center;">Print Menu</p> </div> </div>
	<p>Prompts user before clearing all saved combustion tests from memory.</p> <div style="border: 1px solid black; padding: 2px; margin: 10px auto; width: fit-content;"> <p style="text-align: center;">Clear Memory</p> <p>No</p> <p>Yes</p> <p style="text-align: center;">Menu</p> </div>



Memory Options	Function
<pre> Memory Options Memory Directory Clear Memory Print Average Menu </pre>	<p>Print Average (Sievert Only) displays the memory directory with the first 3 samples highlighted. Use the UP (▲) and DOWN (▼) arrow buttons to move the scrolling window up and down to select which three contiguous samples are to be averaged, then press ENTER.</p>
<pre> Print Average 1 16/07/12 08:46:16 2 16/07/12 08:46:23 3 16/07/12 08:46:31 4 16/07/12 08:46:37 PAGE- Menu PAGE+ </pre>	<pre> Print Average 1 16/07/12 08:46:16 2 16/07/12 08:46:23 3 16/07/12 08:46:31 4 16/07/12 08:46:37 PAGE- Menu PAGE+ </pre>
<pre> Avg: 2-4 NGAS O2 20.8 % CO 0 ppm LAMBDA *** CO2 *** % Print Menu </pre>	<p>The average is calculated, displayed, and available for printing (left). If fewer than 3 samples exist, the average is not calculated (right).</p> <pre> Print Average 1 16/07/12 08:54:41 2 16/07/12 08:54:47 PAGE- Menu PAGE+ </pre>

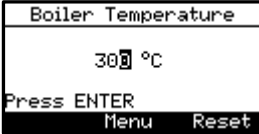

























3.7. Setup Menu



Setup Menu	Function
 <pre> Setup Menu Temperature Units Clock O2 Reference Username Menu </pre>	<p>Access Temperature Units (°C or °F) to be used by the instrument and for display and printing purposes.</p> <p>Use the UP (▲) and DOWN (▼) arrows buttons to highlight the desired choice.</p> <p>Press the ENTER button to use the selected temperature unit. Press ESC to quit without saving.</p>  <pre> Temp Units Menu Celsius Fahrenheit 05/07/12 04:04:50 PM Menu </pre>
 <pre> Setup Menu Temperature Units Smoke Number Oil Derivative Boiler Temperature Menu </pre>	<p>Smoke Number (Sievert only) is used to calculate and display an average smoke value based on 3 smoke test results that are entered by the user. A sample smoke scale is shown below.</p>  <p>Perform 3 smoke tests then enter the results in the 3 smoke number parameters shown below.</p> <p>Use the UP (▲) and DOWN (▼) arrow buttons to highlight smoke number 1, 2, or 3, then press ENTER.</p> <p>Use the LEFT (◀) and RIGHT (▶) arrow buttons to set the smoke number (0-9) that most closely matches the numerical value on your smoke scale for that sample. Press ENTER when finished. The average smoke number is displayed, and will be included on printouts.</p>  <pre> Setup Menu Temperature Units Smoke Number Oil Derivative Boiler Temperature Menu </pre>  <pre> Smoke Number Smoke No. 1: 0 Smoke No. 2: 0 Smoke No. 3: 0 Press ENTER Menu Reset </pre>





Setup Menu	Function															
	<table border="1"> <tr><td>Smoke Number</td></tr> <tr><td>Smoke No. 1: 2</td></tr> <tr><td>Smoke No. 2: 3</td></tr> <tr><td>Smoke No. 3: 5</td></tr> <tr><td>Press ENTER</td></tr> <tr><td>Menu Reset</td></tr> </table>	Smoke Number	Smoke No. 1: 2	Smoke No. 2: 3	Smoke No. 3: 5	Press ENTER	Menu Reset	<table border="1"> <tr><td>Smoke Number</td></tr> <tr><td>Average Smoke No.: 4</td></tr> <tr><td>Press ENTER</td></tr> <tr><td>Menu</td></tr> </table>	Smoke Number	Average Smoke No.: 4	Press ENTER	Menu				
Smoke Number																
Smoke No. 1: 2																
Smoke No. 2: 3																
Smoke No. 3: 5																
Press ENTER																
Menu Reset																
Smoke Number																
Average Smoke No.: 4																
Press ENTER																
Menu																
<table border="1"> <tr><td>Setup Menu</td></tr> <tr><td>Temperature Units</td></tr> <tr><td>Smoke Number</td></tr> <tr><td>Oil Derivative</td></tr> <tr><td>Boiler Temperature</td></tr> <tr><td>Menu</td></tr> </table>	Setup Menu	Temperature Units	Smoke Number	Oil Derivative	Boiler Temperature	Menu	<p>WARNING: DO NOT use the Fyrite® InTech® to sample gas from an oil-based combustion system without first doing a smoke test and adjusting your combustion process as needed. Smoke test results of greater than 1 indicate improper combustion, and demonstrate the need for process adjustment. Only use the Fyrite® InTech® to sample flue gas AFTER the combustion process is adjusted and the smoke test indicates a smoke level of 0 or 1.</p>  <p>Oil Derivative (Siegert only) specifies whether or not oil derivatives were present during the smoke tests (see page 24).</p> <p>For incomplete combustion, oil derivatives present in the sample can be precipitated onto the filter paper, causing a color change in the smoke spot.</p> <p>Use the UP (▲) and DOWN (▼) arrow buttons to select the YES option if oil derivatives were present during the smoke test. Otherwise select NO and press ENTER.</p> <table border="1"> <tr><td>Oil Derivative</td></tr> <tr><td>No</td></tr> <tr><td>Yes</td></tr> <tr><td>Menu Reset</td></tr> </table> <table border="1"> <tr><td>Oil Derivative</td></tr> <tr><td>No</td></tr> <tr><td>Yes</td></tr> <tr><td>Menu Reset</td></tr> </table> <p>This information is included on printouts.</p>		Oil Derivative	No	Yes	Menu Reset	Oil Derivative	No	Yes	Menu Reset
Setup Menu																
Temperature Units																
Smoke Number																
Oil Derivative																
Boiler Temperature																
Menu																
Oil Derivative																
No																
Yes																
Menu Reset																
Oil Derivative																
No																
Yes																
Menu Reset																









Setup Menu	Function
 <p>Setup Menu Temperature Units Smoke Number Dil Derivative Boiler Temperature Menu</p>	<p>A boiler temperature (Sievert only) can be recorded manually. Enter the boiler temperature as measured by an external thermocouple.</p> <p>Use the LEFT (◀) and RIGHT (▶) arrow buttons to change position. Use the UP (▲) and DOWN (▼) arrow buttons to scroll through numerals 0-9 for the selected position. Press ENTER when finished.</p> <p style="text-align: center;">Select Position Change Value</p> <div style="display: flex; justify-content: space-around;"> <div data-bbox="407 464 668 597">  <p>Boiler Temperature 000 °C Press ENTER Menu Reset</p> </div> <div data-bbox="684 464 944 597">  <p>Boiler Temperature 300 °C Press ENTER Menu Reset</p> </div> </div>
 <p>Setup Menu Dil Derivative Boiler Temperature Clock D₂ Reference Menu</p>	<p>The Clock option provides access to the clock setup function to set date and time.</p> <p>Use the LEFT (◀) and RIGHT (▶) arrow buttons to select the desired field to edit. Then use the UP (▲) and DOWN (▼) arrow buttons to change the values of the selected field.</p> <p>Press ENTER to save new date and time. Press ESC to quit without saving.</p> <hr/> <p> NOTE: See DATE FORMAT option in SETUP MENU to select either MM/DD/YY format or DD/MM/YY format (for North American configurations only).</p> <hr/> <p> NOTE: Sievert configurations display time and date information in DD/MM/YY and 24-hour time format only.</p> <p>Time and date information in North American configurations is user-selectable (see Date Format setting on page 31) between:</p> <ul style="list-style-type: none"> • MM/DD/YY w/ 12-hr time format or • DD/MM/YY w/ 24-hr time format.

Setup Menu	Function
	<div data-bbox="546 207 809 342" style="border: 1px solid black; padding: 5px; margin-bottom: 10px;"> <p style="text-align: center;">Set Clock</p> <p style="text-align: center;">05/07/12 04:05 PM</p> <p style="text-align: center;">Press ENTER to Save</p> <p style="text-align: center;">05/07/12 04:05:10 PM</p> <p style="text-align: center;">Menu</p> </div> <hr/> <p>NOTE: The presence of AM or PM after the time on the Set Clock display indicates 12-hour time format and MM/DD/YY date format. (This also indicates that the instrument must be in the North American configuration.)</p>  <p>Similarly, the absence of AM or PM indicates 24-hour time format and the date is in DD/MM/YY format (either by default if Siegert configuration, or by choice through the Date Format parameter if North American configuration).</p> <hr/>
<div data-bbox="110 813 375 948" style="border: 1px solid black; padding: 5px;"> <p style="text-align: center;">Setup Menu</p> <p>Temperature Units</p> <p>Clock</p> <p>O₂ Reference</p> <p>Username</p> <p style="text-align: center;">Menu</p> </div>	<p>The measured value of CO can be referenced to a specific O₂ percentage (0% to 15%) as referenced in the equation below.</p> $CO(n) = \frac{20.9 - O_2 \text{ Reference}}{20.9 - O_2 \text{ Measured}} \times CO$ <p>Use the UP (▲) and DOWN (▼) arrow buttons to enter the O₂ reference value (n) from 0% to 15%. Press ENTER to save the selection or ESC to revert to the previous setting.</p> <div data-bbox="546 1141 809 1276" style="border: 1px solid black; padding: 5px; margin-top: 10px;"> <p style="text-align: center;">Set O₂ Reference</p> <p>CO ref to O₂: 0</p> <p style="text-align: center;">05/07/12 04:06:12 PM</p> <p style="text-align: center;">Menu</p> </div> <hr/>  <p>NOTE: The O₂ reference has a default value of 0%. CO with respect to a 0% O₂ reference is also known as <i>CO Air Free</i> or CO(0).</p> <hr/>







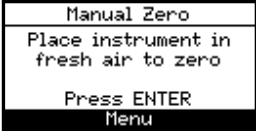

Setup Menu	Function										
	<p>Provides an interface for entering user identification information used on printouts. Generally, the Username fields contain the HVAC company and related information.</p> <hr/> <p> NOTE: This data can be entered using the Fyrite[®] User Software (FUS).</p> <hr/> <p>Use the UP (▲) and DOWN (▼) arrow buttons to choose a row and press ENTER to begin editing the selected row. Then use the UP (▲) and DOWN (▼) arrow buttons to select the desired letter, number, or special character for the current text position.</p> <p style="text-align: center;">/ ! @ # \$ & * - ' <SPACE> a-z A-Z 0-9</p> <p>Use the LEFT (◀) and RIGHT (▶) arrow buttons to move the cursor horizontally on the selected row and repeat the character selection process for each text position. When finished, press ENTER to save the row's changes. Repeat for all 3 lines. Then select EDIT COMPLETE and press ENTER to finish.</p> <table border="1" style="width: 100%; text-align: center;"> <thead> <tr> <th data-bbox="407 867 668 894">SELECT MODE</th> <th data-bbox="678 867 939 894">EDITING MODE</th> </tr> </thead> <tbody> <tr> <td data-bbox="407 899 668 1032">  </td> <td data-bbox="678 899 939 1032">  </td> </tr> <tr> <td data-bbox="407 1040 668 1174">  </td> <td data-bbox="678 1040 939 1174">  </td> </tr> <tr> <td data-bbox="407 1182 668 1315">  </td> <td data-bbox="678 1182 939 1315">  </td> </tr> <tr> <td data-bbox="407 1323 668 1456">  </td> <td data-bbox="678 1323 939 1456">  </td> </tr> </tbody> </table>	SELECT MODE	EDITING MODE								
SELECT MODE	EDITING MODE										
											
											
											
											



Setup Menu	Function																											
	<p>The Language Selection option allows the user to choose a language for all menus. Use the UP (▲) and DOWN (▼) arrow buttons to scroll through language options (varies based on instrument model). Use ENTER to enable the selected language.</p> <div style="text-align: center; margin: 10px 0;">  </div> <hr/> <div style="display: flex; align-items: center; margin: 10px 0;"> <p>NOTE: The number of available languages may differ based on the combustion equation setting.</p> </div> <hr/> <p>Three languages are available for North American (NA) configurations and eight languages are available for Siegert (S) configurations. Refer to the table below and the SETUP MENU for more information.</p> <table border="1" style="margin: 10px auto; border-collapse: collapse; text-align: center;"> <thead> <tr> <th></th> <th>English</th> <th>French</th> <th>Spanish</th> <th>German</th> <th>Italian</th> <th>Danish</th> <th>Polish</th> <th>Dutch</th> </tr> </thead> <tbody> <tr> <td>NA</td> <td>•</td> <td>•</td> <td>•</td> <td></td> <td></td> <td></td> <td></td> <td></td> </tr> <tr> <td>S</td> <td>•</td> <td>•</td> <td>•</td> <td>•</td> <td>•</td> <td>•</td> <td>•</td> <td>•</td> </tr> </tbody> </table>		English	French	Spanish	German	Italian	Danish	Polish	Dutch	NA	•	•	•						S	•	•	•	•	•	•	•	•
	English	French	Spanish	German	Italian	Danish	Polish	Dutch																				
NA	•	•	•																									
S	•	•	•	•	•	•	•	•																				

Setup Menu	Function
	<p>Provides a list from which to select an inactivity (key press) timeout for automatic shutdown. If no key presses occur for the time specified, the Fyrite® InTech® initiates an automatic shutdown.</p> <p>Use the UP (▲) and DOWN (▼) arrow buttons to scroll through Inactivity Timeout options (never [default], 20, 30, or 60 minutes). Use the ENTER key to enable the selected timeout.</p>  <hr/> <p>IMPORTANT: The instrument overrides the inactivity timeout, cancels the automatic shutdown (that is, the instrument remains ON), and restarts the timeout countdown if:</p>  <ul style="list-style-type: none"> • any key is pressed, • CO is greater than 50 ppm, or • O₂ is less than 18.8 %.
	<p>Provides a list from which the user may chose a <i>minimum</i> purge duration time (<i>minimum</i> length of time that the pump continues to run) after shutdown is initiated. Use a longer Post-Purge Period if the Fyrite® InTech® has been exposed to large amounts of CO gas. Use ENTER to enable the selected Post-Purge Period. “PURGING SENSORS” is displayed on the shutdown screen if a Post-Purge Period is enabled.</p> <p>Use the UP (▲) and DOWN (▼) arrow buttons to scroll through Post-purge Period options.</p> 

Setup Menu	Function
	<p>Date format (North American Configuration only)</p> <p>Provides a list from which the user may select the desired date format used by the instrument:</p> <ul style="list-style-type: none"> • MM/DD/YY (default for NA configurations) • DD/MM/YY (standard for Siegert) <hr/> <p> NOTE: The DD/MM/YY date format is the only format available in instruments configured with Siegert combustion equations. This parameter is only available in North American configurations.</p> <hr/> <p>Use the UP (▲) and DOWN (▼) arrow buttons to highlight the desired date format. Press ENTER to save new date format. Press ESC to quit without saving.</p> <div style="display: flex; justify-content: space-around;"> <div data-bbox="419 716 668 846">  </div> <div data-bbox="687 716 936 846">  </div> </div>
	<p>Provides a list from which the user may select the desired method for zeroing the CO sensor.</p> <ul style="list-style-type: none"> • <i>Auto-Zero</i> happens automatically at warm-up. • <i>Manual zero</i> is used to initiate the zeroing process whenever desired. <p>Use the UP (▲) and DOWN (▼) arrow buttons to highlight the desired zeroing method.</p> <p>Press ENTER to save. Press ESC to quit without saving.</p> <div style="display: flex; justify-content: space-around;"> <div data-bbox="450 1122 602 1144"> <p>CO AUTO ZERO</p> </div> <div data-bbox="705 1122 892 1144"> <p>CO MANUAL ZERO</p> </div> </div> <div style="display: flex; justify-content: space-around;"> <div data-bbox="407 1154 663 1284">  </div> <div data-bbox="676 1154 933 1284">  </div> </div> <div style="display: flex; justify-content: space-around;"> <div data-bbox="407 1292 663 1422">  </div> <div data-bbox="676 1292 933 1422">  </div> </div>



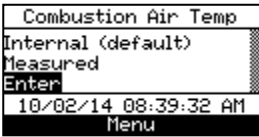

Setup Menu	Function
	<div data-bbox="407 199 665 332" style="border: 1px solid black; padding: 5px;"> <p style="text-align: center;">Fyrite® INTECH™ Warm Up: 46 CO-Auto-Zero</p> </div> <div data-bbox="675 199 933 332" style="border: 1px solid black; padding: 5px;"> <p style="text-align: center;">Setting Manual Zero Warm Up: 45</p> </div> <p>By default, the Fyrite® InTech® automatically zeroes all sensors on ambient air when the instrument is turned on.</p> <p>The Fyrite® InTech® can be set to perform and store a manual zero for the CO sensor. The instrument uses the stored value to indicate background CO values after warm-up instead of performing an auto-zero on the background gas.</p>
<div data-bbox="109 638 375 771" style="border: 1px solid black; padding: 5px;"> <p style="text-align: center;">Setup Menu</p> <p>Inactivity Timeout Post-purge Period CO Zero Setting Combustion Equations Menu</p> </div>	<p>The COMBUSTION EQUATIONS menu allows the user to select either Siegert combustion equations or North American combustion equations.</p> <p>Use UP (▲) and DOWN (▼) arrow buttons to highlight the desired option. Press ENTER to select.</p> <div data-bbox="407 795 665 928" style="border: 1px solid black; padding: 5px;"> <p style="text-align: center;">Combustion Equations</p> <p>Siegert North American</p> <hr/> <p style="text-align: center;">02/06/12 12:15:34</p> <p style="text-align: center;">Menu</p> </div> <div data-bbox="675 795 933 928" style="border: 1px solid black; padding: 5px;"> <p style="text-align: center;">Combustion Equations</p> <p>Siegert North American</p> <hr/> <p style="text-align: center;">02/06/12 12:15:42</p> <p style="text-align: center;">Menu</p> </div> <div data-bbox="547 937 809 1070" style="border: 1px solid black; padding: 5px;"> <p style="text-align: center;">Are You Sure?</p> <p>No Yes</p> <p style="text-align: center;">Settings and test records will be deleted</p> <p style="text-align: center;">Menu</p> </div> <div data-bbox="547 1078 809 1211" style="border: 1px solid black; padding: 5px;"> <p style="text-align: center;">Language Selection</p> <p>English Français Español</p> <hr/> <p style="text-align: center;">02/06/12 12:16:35</p> <p style="text-align: center;">Cancel</p> </div> <div data-bbox="407 1219 665 1352" style="border: 1px solid black; padding: 5px;"> <p style="text-align: center;">Successful</p> <p style="text-align: center;">Combustion Changed To North American</p> </div> <div data-bbox="675 1219 933 1352" style="border: 1px solid black; padding: 5px;"> <p style="text-align: center;">Successful</p> <p style="text-align: center;">Combustion Changed To Siegert</p> </div>

Setup Menu	Function										
	<p> IMPORTANT: Changing this setting resets several configuration parameters to their default values. Below is a list of affected parameters, and those unaffected.</p> <table border="1" data-bbox="421 412 951 662"> <thead> <tr> <th>Reset to Default Values</th> <th>Unchanged</th> </tr> </thead> <tbody> <tr> <td>Temperature units</td> <td>Manual/Auto zero</td> </tr> <tr> <td>O₂ (Oxygen) reference</td> <td>Calibration data</td> </tr> <tr> <td>Fuel</td> <td>User name</td> </tr> <tr> <td>Memory erased</td> <td>Clock</td> </tr> </tbody> </table>	Reset to Default Values	Unchanged	Temperature units	Manual/Auto zero	O ₂ (Oxygen) reference	Calibration data	Fuel	User name	Memory erased	Clock
Reset to Default Values	Unchanged										
Temperature units	Manual/Auto zero										
O ₂ (Oxygen) reference	Calibration data										
Fuel	User name										
Memory erased	Clock										
	<p>The CO Protect feature protects the CO sensor from the negative effects of being overloaded with CO gas. Such negative effects include:</p> <ul style="list-style-type: none"> • a longer sensor recovery time • a shortened sensor life. <p>The CO sensor is an electro-chemical sensor whose lifespan is a function of its exposure to the target gas (CO in this case). Though the CO sensor is designed to be used in combustion environments having a fairly wide range of CO gas present, limiting unnecessary overexposure to CO gas can greatly increase the life expectancy of the CO sensor. In addition, it can shorten sensor recovery time after exposure.</p> <table border="1" data-bbox="410 1086 948 1219"> <tr> <td data-bbox="410 1086 671 1219">  </td> <td data-bbox="685 1086 948 1219">  </td> </tr> </table> <p>The Protect CO feature sets a protection threshold above which the analyzer’s pump shuts off, limiting the CO sensor’s exposure to the high levels of CO gas and its negative effects. Enter the Protect CO screen from the Setup Menu. Select the “ON” option and press the ENTER key. The CO threshold limit is displayed. Use the up and down arrows to modify the CO limit</p>										
											







Setup Menu	Function
	<p>threshold value (in 100 ppm increments) before returning to the Main Menu.</p> <p>During combustion analysis, if the Protect CO feature is enabled and the CO reading equals or exceeds the CO Limit setting, the analyzer shuts off the pump and prompts the operator for a course of action.</p> <ul style="list-style-type: none"> Continue (and risk sensor damage) Purge <p>Continue Option:</p> <ul style="list-style-type: none"> Pump starts. Future High CO warnings are suppressed until CO drops below 100 ppm. After CO drops below 100 ppm, the analyzer begins enforcing the current Protect CO threshold limit again. <p>Purge Option:</p> <ul style="list-style-type: none"> Remove probe tip from flue and press ENTER. Pump starts. Purge begins. Measured CO is displayed. Purge ends when CO level drops below 50 ppm.
 <pre> Setup Menu CO Zero Setting Combustion Equations Protect CO Combustion Air Temp Menu </pre>	<p>The Combustion Air Temp option allows you to select a source for the combustion air temperature (T-Air) used by the analyzer for calculations. There are 3 choices.</p> <div style="display: flex; justify-content: space-between;"> <div style="width: 45%;">  <pre> Combustion Air Temp Internal (default) Measured Enter 10/02/14 08:39:13 AM Menu </pre> </div> <div style="width: 45%;"> <p>1: T-Air value is read dynamically from the temperature sensor inside the analyzer.</p> </div> </div> <div style="display: flex; justify-content: space-between; margin-top: 10px;"> <div style="width: 45%;">  <pre> Combustion Air Temp Internal (default) Measured Enter 10/02/14 08:39:24 AM Menu </pre> </div> <div style="width: 45%;"> <p>2: Temporarily use probe (T-STK) to get T-AIR value. When ready, press ENTER to save displayed reading. Value is saved and used as fixed T-AIR value. After save, the probe (thermocouple) is used for taking T-STK readings again.</p> </div> </div>



Setup Menu	Function
	<p>3: T-Air value is manually entered by the operator. Use arrow keys to change sign and digits. Use ENTER to save T-Air value.</p>

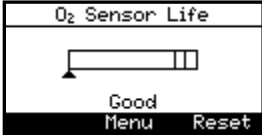
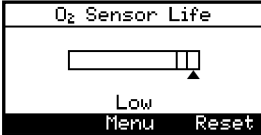

3.8. Calibration Menu

Calibration Menu	Function
	<p>Calibration is performed by applying known values and accessing the password-protected menu items. When the Calibration Menu is selected, the user must enter a 4-digit numeric security code in order to proceed to the calibration options. The default password is 1111.</p>
<p>Use the UP (▲) and DOWN (▼) arrow buttons to scroll through numerals 0-9 until the desired numeral is reached. Press ENTER to advance to the next position of the password. Press ENTER after all four digits are set. Press ESC to return to the SETUP MENU.</p>	
 <p>NOTE: The calibration password can be changed through the Fyrite® User Software (FUS).</p>	<hr/>
	<p>Refer to Chapter 5 (page 49) for additional screens and calibration procedures.</p>



3.9. Diagnostics Menu

Diagnostics Menu	Function
	<p>Displays time metrics for pump use and total operation time.</p> 
	<p>Displays information about the measurement sensors of the instrument.</p> 
	<p>Displays the <i>estimated</i> oxygen (O₂) sensor life based on:</p> <ul style="list-style-type: none"> the sensor's 3-digit date code that you enter (from the label on the sensor) the current date that you set the typical O₂ sensor life of approximately 24 months. <div style="display: flex; justify-content: space-around;"> <div data-bbox="410 911 673 1045">  </div> <div data-bbox="682 911 944 1045">  </div> </div> <div style="text-align: center; margin-top: 20px;">  </div> <p>The Fyrite® InTech® will show that the O₂ sensor needs to be replaced, and an error message is displayed (see below).</p> <div style="text-align: center; margin-top: 20px;">  </div>

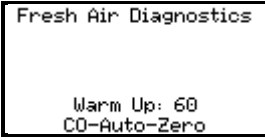
Diagnostics Menu	Function																																
	<p>In this case:</p> <ul style="list-style-type: none"> • Note the 3-digit date code on the new sensor • Replace the O₂ sensor • Press F3 to change and verify sensor date code. <p>Resetting the Sensor Date Code</p> <p>Use the LEFT (◀) and RIGHT (▶) arrow buttons to move the cursor horizontally to select between the 2-digit month code (00-12) and the one digit year code (0-9 corresponding to the last digit of the manufacture year) that make up the 3-digit date code.</p> <p>Use UP (▲) and DOWN (▼) arrow buttons to increment and decrement the selected field's value. When finished, press ENTER to save the changes.</p> <div style="display: flex; justify-content: space-around;"> <table border="1" data-bbox="412 623 674 756"> <tr><th colspan="2">Enter Code</th></tr> <tr><td colspan="2">Enter O₂ date code</td></tr> <tr><td style="text-align: center;">013</td><td style="text-align: center;"> </td></tr> <tr><th colspan="2">Menu</th></tr> </table> <table border="1" data-bbox="685 623 946 756"> <tr><th colspan="2">Enter Code</th></tr> <tr><td colspan="2">Enter O₂ date code</td></tr> <tr><td style="text-align: center;">013</td><td style="text-align: center;"> </td></tr> <tr><th colspan="2">Menu</th></tr> </table> </div> <hr/> <div style="display: flex; align-items: center;">  <p>NOTE: Entering a value of 000 (three zeros) disables this feature.</p> </div> <hr/> <p>Next, verify the current month and year. Use the arrow keys to edit the current month and year (if needed) and press ENTER to confirm.</p> <div style="display: flex; justify-content: space-around;"> <table border="1" data-bbox="412 1010 674 1143"> <tr><th colspan="2">Set Clock</th></tr> <tr><td colspan="2">Verify the month/year</td></tr> <tr><td style="text-align: center;">06/2012</td><td style="text-align: center;"> </td></tr> <tr><th colspan="2">Menu</th></tr> </table> <table border="1" data-bbox="685 1010 946 1143"> <tr><th colspan="2">Set Clock</th></tr> <tr><td colspan="2">Verify the month/year</td></tr> <tr><td style="text-align: center;">06/2012</td><td style="text-align: center;"> </td></tr> <tr><th colspan="2">Menu</th></tr> </table> </div> <hr/> <div style="display: flex; align-items: center;">  <p>NOTE: Use this feature as a reminder only. This status is based on:</p> <ul style="list-style-type: none"> • the date code on the sensor (that you enter) • the current date (that you enter) • the typical O₂ life span (2 years) • the output of the sensor </div>	Enter Code		Enter O ₂ date code		013		Menu		Enter Code		Enter O ₂ date code		013		Menu		Set Clock		Verify the month/year		06/2012		Menu		Set Clock		Verify the month/year		06/2012		Menu	
Enter Code																																	
Enter O ₂ date code																																	
013																																	
Menu																																	
Enter Code																																	
Enter O ₂ date code																																	
013																																	
Menu																																	
Set Clock																																	
Verify the month/year																																	
06/2012																																	
Menu																																	
Set Clock																																	
Verify the month/year																																	
06/2012																																	
Menu																																	

Diagnostics Menu	Function
	<p> NOTE: If either of the entered values is incorrect, the status of your O₂ sensor life will not be accurate. Actual sensor life may vary.</p>
	<p>Displays fresh air diagnostics similar to the display at warm-up. After the warm-up countdown, any detected errors are displayed. Otherwise, a "Success" message is displayed.</p> <div style="text-align: center;">  </div> <div style="display: flex; justify-content: space-around;"> <div style="border: 1px solid black; padding: 5px; width: 45%;"> <p style="text-align: center;">Errors Detected</p> <p>T-STK Disconnected Replace Sensors O₂</p> <p style="text-align: center;">Menu</p> </div> <div style="border: 1px solid black; padding: 5px; width: 45%;"> <p style="text-align: center;">No Errors</p> <p>Diag Successful</p> <p style="text-align: center;">Menu</p> </div> </div>

3.10. Status Menu

Status Menu	Function
	<p>This is the device status screen which displays information about the device. Some of the information displayed on this screen includes serial number, firmware version, model number, etc.</p> <div style="text-align: center;">  </div>



Section 4. Operation

4.1. Prerequisites

Before beginning your combustion test, verify the following:

- menu items are properly configured
- the water trap is empty, filter is clean, and arrow is pointing UP
- the probe and thermocouple are attached to the instrument
- the power is ON and sufficient (one of the following):
 - four new batteries (AA alkaline)
 - four new batteries (AA lithium)
 - four fully-charged AA rechargeable batteries
- the warm-up process has completed in fresh air without interruption or errors.

4.2. Sampling Point Examples



WARNING: The illustrations of combustion devices and sampling points in this section are examples only. Be sure to consult with the manufacturer's documentation for the combustion devices you are servicing.

The following combustion devices and example sampling points are shown and explained below:

- Example forced air furnace
- Example hot water tank
- Example 90% efficiency condensing furnace
- Example 80% efficiency fan assist or power vented furnace
- Example atmospheric/gravity vented boiler

Example Forced Air Furnace

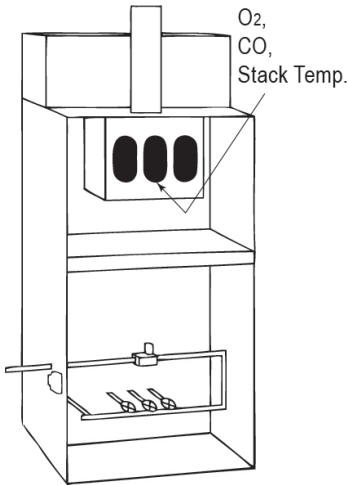

For atmospheric burner or gravity vented, forced air heating equipment with a clamshell or sectional heat exchanger design, test each of the exhaust ports at the top of the heat exchanger. The probe should be inserted back into each of the exhaust ports to obtain a flue gas sample, before any dilution air is mixed in.

Example Hot Water Tank

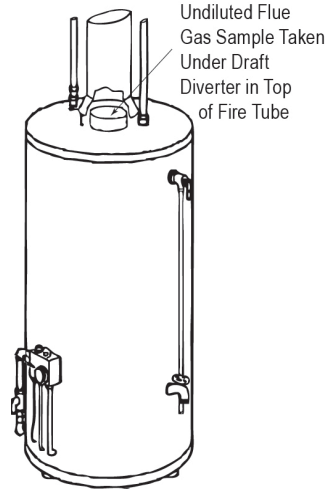

Domestic hot water tanks with the 'bell' shaped draft diverter can be accurately tested by inserting the probe tip directly into the top of the fire tube below the diverter.

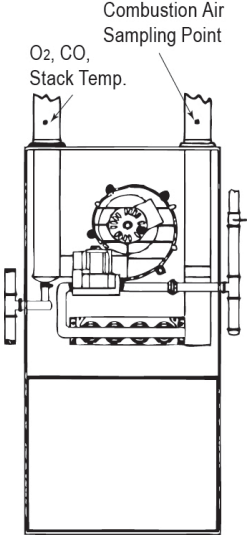
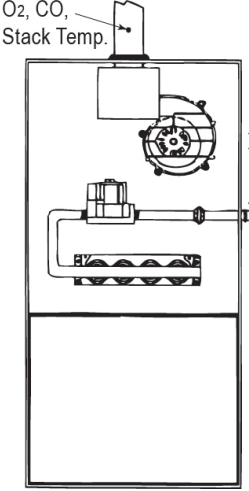
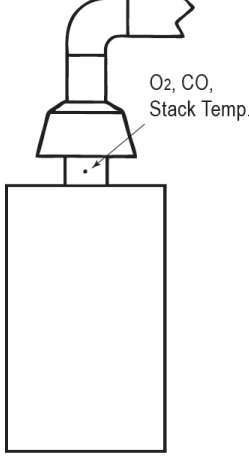
Example 90% Efficiency Condensing Furnace	Example 80% Efficiency Fan Assist or Power Vented Furnace	Example Atmospheric/Gravity Vented Boiler
 <p>Combustion Air Sampling Point O₂, CO, Stack Temp.</p> <p>Condensing furnaces/boilers can be tested through a hole drilled in the plastic vent pipe (when allowed by the manufacturer or local authority of jurisdiction) or taken from the exhaust termination.</p>	 <p>O₂, CO, Stack Temp.</p> <p>Combustion testing of fan assist or power vented, furnaces/boilers should be done through a hole drilled in the vent immediately above the inducer fan.</p>	 <p>O₂, CO, Stack Temp.</p> <p>Boilers, which have a 'bell' shaped draft diverter on top, should be tested directly below the diverter through a hole drilled in the vent connector.</p>



IMPORTANT: Review manufacturer recommendations for the combustion device being tested, and be aware of accepted practices of the local jurisdiction before introducing sampling holes into exhaust pipes or ducts.



CAUTION: To avoid the introduction of dangerous exhaust gases into the space, be sure to completely and securely seal any sampling holes made in the exhaust pipes or ducts.

4.3. Combustion Testing Process



WARNING: The Fyrite® InTech® calculates combustion parameters based on North American or Siegert combustion equations. NA or Siegert configuration is selected in the SETUP MENU. Be sure that your Fyrite® InTech® is properly configured for your region and desired combustion calculations.



NOTE: The recommended time required to achieve a stable measurement is a minimum of 3 minutes.

Step	Example Combustion Testing Procedure
1	Confirm that testing prerequisites have been completed.
2	Based on the sampling point examples and your particular combustion application, locate and prepare an appropriate sampling point.
3	Insert the probe into the combustion location.
4	Press the RUN/HOLD button to begin sampling gas. You should see the word RUN in the upper left corner of the display and hear the sample pump turn on. If you see the word HOLD, press the RUN/HOLD button again.
5	Monitor the display for combustion data.
6	If desired, turn on your optional IrDA printer, then press the F1 button on the Fyrite® InTech® to print the current combustion data.
7	Press the F3 button as desired to save combustion data for later retrieval, review, and/or printing.
8	Press the RUN/HOLD button to stop the test. You should see the word HOLD in the upper left corner of the display and hear the sample pump turn OFF. If you see the word RUN, press the RUN/HOLD button again.
9	Remove the probe from the sampling point. <div style="text-align: center;">  <p>CAUTION: The probe may be very hot. Allow it to cool, then wipe it clean with a dry cloth.</p> </div>
10	Move the instrument to a clean air environment and press the POWER button to turn off the instrument. The shutdown procedure includes a

Step	Example Combustion Testing Procedure
	purge component that clears the sensors of combustion gases.
11	Turn on the instrument to optionally print and/or evaluate saved test results (based on your local codes and practices for combustion data and CO levels).
12	To turn off the Fyrite [®] InTech [®] , press and hold the POWER button until you see the Shutdown timer. Wait for the purge function to complete (you will hear the pump stop and the display will shut off).

Use the results of your combustion testing to assist in diagnosing any issues or potential issues that may exist with the combustion system.



WARNING: CO gas is life-threatening and part of all combustion processes. Be sure to thoroughly evaluate systems and take ALL appropriate actions to maintain life safety.

4.4. The RUN Screen

Sample Main Menu
with North American
Combustion Equations
Enabled

Toggle
Between
Run and
Hold Modes

Sample Main Menu
with Siegart
Combustion Equations
Enabled

Battery
Status
Icon

Print Menu Save

Print Menu Save

F1 F2 F3

Print Screen to Optional Printer Display Main Menu Save Results to Memory

Scroll Bar
Indicating
More
Items

Print Menu Save

Combustion Test Parameters	NA	Siegert
Oxygen	O ₂	O ₂
Carbon Monoxide	CO	CO
Excess Air	EA	Lambda
Efficiency Using Higher Heating Value	Eff	Eff
Carbon Dioxide	CO ₂	CO ₂
Setting for Maximum Carbon Dioxide in Flue Gas		CO ₂ Max
Stack Temperature	T-STK	T-STK
Ambient Air Temperature	T-AIR	T-AIR
Stack Loss		qA
Efficiency Using Lower Heating Value		Eta
Carbon Monoxide/Carbon Dioxide Ratio		CO/CO ₂
CO content referenced to an Oxygen percentage <i>n</i>	CO(<i>n</i>)	CO(<i>n</i>)
Average of 3 Manually Entered Smoke Numbers		AVG SMOKE
Presence of Oil Derivatives (Manually Entered)		OIL DERIVE
Boiler Temperature (Manually Entered)		BOILER TEMP

4.5. Printing Using the Optional IrDA Printer

The instrument has the ability to store, recall (to the display), and print sets of time- and date-coded test records. The time and date are set through software menu selections.

- Displaying stored records is done through the MEMORY DIRECTORY MENU.
- Press F1 to print displayed test records.

Step	Example Printing Procedure Using Optional IrDA Printer
1	Fyrite [®] InTech [®] should be turned on and displaying a screen with an F1 Print option.
2	Check for a sufficient supply of paper and batteries in the IrDA printer.
3	Turn on the printer (slide switch on side of printer to the ON position)
4	Position the printer within 8 to 16 inches (20 to 41 cm) from the instrument and at no greater than a 60-degree angle.
5	Press F1 to print.
6	Turn off printer when complete.

Sample Run Screen Printouts for North American (left) and Siegert (right) Combustion Equations are shown below.

ABC Heating and A/C
123 Plenum Parkway
Checking CO 12345

BACHARACH.

BACHARACH, Inc.
InTech
SN: AB1234

=====

Time: 12:53:05
Date: 06/29/12

Fuel
Nat. Gas

O ₂	7.0 %
CO	107 ppm
Eff	80.9 %
CO ₂	7.9 %
T-STK	374 °F
T-AIR	68.0 °F
EA	44.8 %
CO<O>	161 ppm

Comments:

Bridge Street HVAC
Outer Kensington West
London, ENG SW1J 3

BACHARACH.

BACHARACH, Inc.
InTech
SN: AB1234

=====

Time: 12:59:48
Date: 06/29/12

Fuel
NGAS

O ₂	7.0 %
CO	107 ppm
Lambda	1.5
CO ₂	7.8 %
CO ₂ Max	11.8 %
T-STK	190 °C
T-AIR	20.0 °C
qA	9.5 %
Eta	90.5 %
Eff	80.9 %
CO/CO2	0.0014
CO<O>	161 ppm
AVG SMOKE	***
OIL DERIV	***
BOILER TEMP	*** °C

Comments:

Fyrite® InTech® provides three lines of 20 characters for user information. This information will appear with test records when they are printed. User name and optional information are entered via software menu selections in the SETUP MENU or via the Fyrite® User Software (FUS).



IR Communications Settings:

- Baud Rate: 9600
- Data Bits: 8
- Stop Bits: 1
- Parity: None
- Protocol: IRDA-SIR
- Distance: 8-16 in (20-41 cm)
- Angle: 60° maximum

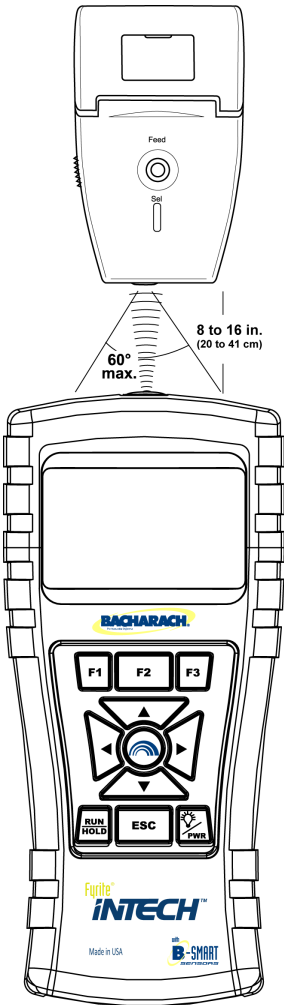

Fyrite® InTech® can be setup to include a custom logo on printouts. Logos are loaded into the instrument using the Fyrite® User Software (FUS). Logo size is limited to 192 x 384 pixels (height x width) and must be in one of the following formats: .BMP, .JPG, .PNG, or .TIFF. For best results, the logo should be saved in black and white.

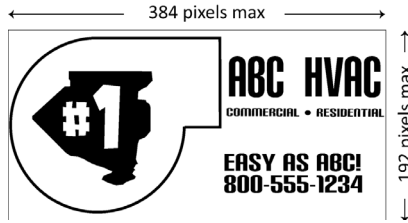

4.6. Taking Ambient CO Measurements

This procedure takes approximately 15 minutes to complete and provides a minute-by-minute snapshot of CO readings, as well as a “Max CO” value that represents the highest CO reading measured during the entire 15-minute test. Results can be saved to memory and/or printed. Use the following procedure to perform an ambient CO measurement.

Step	Example Procedure for Taking Ambient CO Measurements
1	Turn on the InTech® in a fresh air environment and wait for initialization to complete.
2	Verify successful initialization (no errors).
3	Check battery status (see page 15). If battery life is questionable, replace the batteries, as the Ambient CO test takes approximately 15 minutes to complete.
4	Move instrument to target location to be tested.
5	Press F2 to display the Main Menu.
6	Use the down arrow to highlight Ambient CO Test and press the ENTER button.
7	Follow the on-screen instructions to initiate the test.
8	Refer to page 20 for details on navigating the ambient CO test screens, viewing results, saving results to memory, and printing results.

4.7. PC Interface and Fyrite[®] User Software

A PC with Fyrite[®] User Software (FUS) installed can set, edit, and transfer the following:

- instrument time and date
- calibration password
- time meters
- B-SMART[®] code
- user name
- instrument settings
- customer logo
- firmware updates
- language.



Section 5. Calibration and Maintenance

5.1. Serviceability

The instrument operator is able to easily replace the following components without the use of tools:

- probe assembly
- probe filters
- batteries
- printer paper.

Additionally, a technician, with the use of readily available hand tools and factory-provided instructions, can:

- perform basic diagnostics
- replace sensors
- confirm proper operation

before putting the unit back into service. Field calibration is also possible with the proper equipment. Refer to the calibration section for more information.

5.2. Cleaning the Probe

The probe tube and gas sample hose will become dirty under normal use.



NOTE: The water trap's filter element should prevent soot from reaching the analyzer's internal components. If the probe is not kept clean, it could become clogged and restrict the flow of gas into the analyzer, resulting in incorrect combustion test readings and calculations.



NOTE: An analyzer that tests natural gas furnaces normally requires less frequent cleaning than an analyzer used for testing coal- or oil-fired furnaces.

5.2.1. Equipment Required

- Alcohol
- Aerosol Can of Automotive Carburetor Cleaner
- Clean Rag
- Source of Compressed Air (optional)



CAUTION: Do not use flammable or combustible substances (like carburetor fluid used for cleaning the probe) near an open flame.

5.2.2. Procedure

Step	Cleaning the Probe
1	Remove gas sample hose from the top of the water trap. <hr/> CAUTION: Carburetor cleaner damages plastic components. Take precautions not to spray cleaner onto the probe handle or analyzer.
2	Insert the plastic spray tube of the carburetor cleaner into the gas sample hose, and then liberally spray carburetor cleaner through the hose and out the probe tube.
3	After spraying, remove all the residual cleaner by repeatedly flushing the gas hose and probe tube with alcohol.
4	Wipe off the surfaces of the probe and tubing with a clean cloth.
5	Allow the parts to dry completely. If available, blow compressed air through the probe to expedite the drying process.
6	Reconnect gas sample hose to top of the water trap.

5.3. Water Trap and Filter Replacement

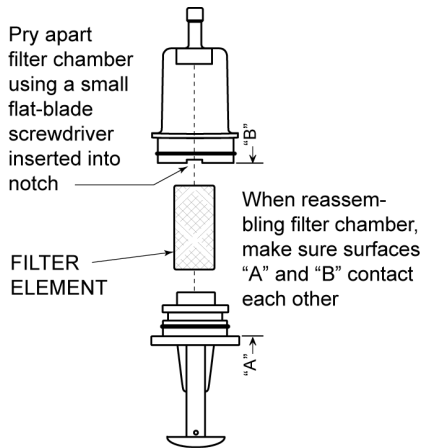
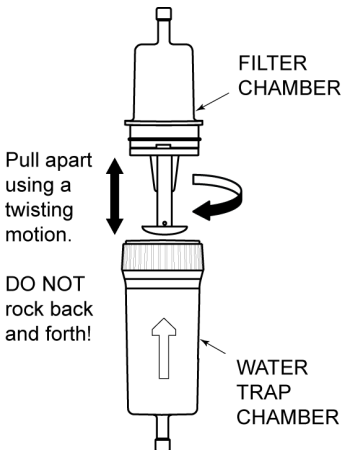
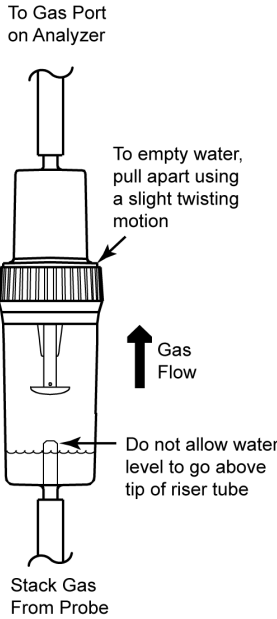

5.4. O₂ and/or CO Sensor Replacement



NOTE: The O₂ sensor life is approximately 2 years. The CO sensor life is greater than 3 years.

5.4.1. Accessing the Sensors

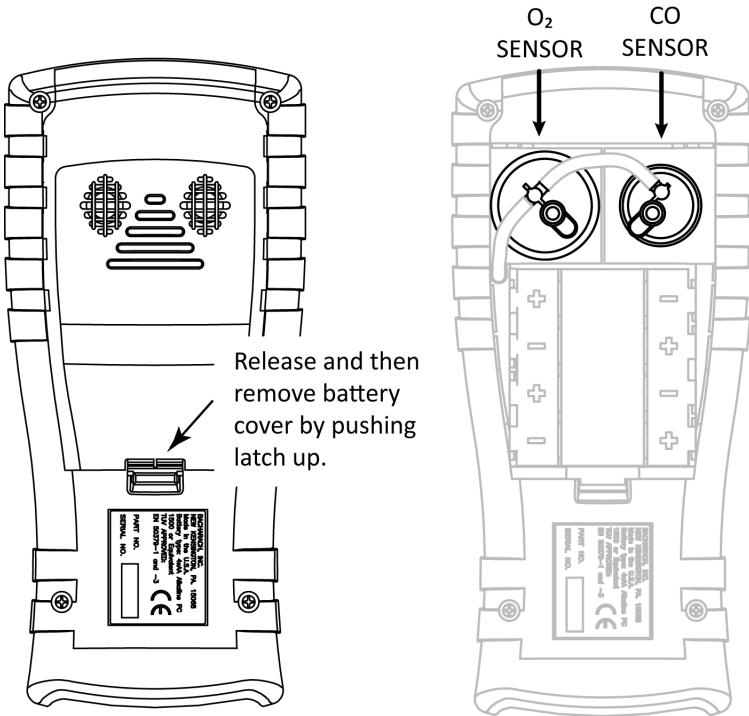

5.4.2. Material Required (As Needed)

- O₂ Sensor (P/N 0024-0788)
- CO Sensor (P/N 0024-7265) or B-Smart® sensor (P/N 0024-1467).

5.4.3. O₂ Sensor Replacement Procedure

Follow the procedure below for O₂ sensors.

Step	O ₂ Sensor Replacement	
1	Remove battery door and connector tubing from both sensors.	
2	Pull O ₂ sensor from its socket.	
3	Remove the O ₂ cap.	
4	Properly dispose of the old sensor.	
5	Note 3-digit date code on new sensor.	
6	Engage the nub on the new sensor within the slot on the cap's side and twist to secure the cap and sensor together.	
7	Install the cap and sensor unit by: <ul style="list-style-type: none"> Aligning the ribs on the sides of the sensor with the corresponding shape in the base. Inserting the pins into the connectors in the base. 	
8	Reattach tubing. Close battery door. Turn on instrument.	
9	After warm-up completes, enter the 3-digit date code (see page 36).	



5.4.4. CO Sensor Replacement Procedure

Follow the procedure below for CO sensor replacement.

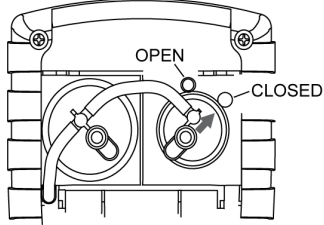
Step	CO Sensor Replacement Procedure	
1	Remove battery door and the connector tubing from the CO sensor.	
2	Remove CO cap by twisting counter clockwise.	
3	Gently pull CO sensor out of its socket.	
4	Properly dispose of the old CO sensor.	
5	Plug new CO sensor into its socket.	
6	Install the CO cap by aligning it toward the "open" position (12 o'clock) as shown	

Step	CO Sensor Replacement Procedure	
	<p>in the diagram below, then twisting the cap clockwise approximately 40° to the "closed" position (2 o'clock).</p>	
7	<p>Reattach tubing.</p>	
8	<p>Calibrate the CO sensor using either the standard calibration procedure or the B-SMART® procedure</p>	

5.4.5. B-SMART® CO Sensor Replacement

Step	B-SMART® CO Sensor Replacement	
1	<p>Enter the CALIBRATION MENU. Note that this requires password validation (see page 35).</p>	
2	<p>Use the UP (▲) and DOWN (▼) arrow buttons to select B-Smart. Press ENTER to display the B-Smart code screen.</p>	
3	<p>Use the UP (▲) and DOWN (▼) arrow buttons to enter the 10-digit alphanumeric code supplied with the pre-calibrated B-SMART® sensor. Use the LEFT (◀) and RIGHT (▶) arrow buttons to move the cursor across the screen. Press ENTER.</p> <div style="display: flex; justify-content: space-around; align-items: center;"> <div style="border: 1px solid black; padding: 5px; width: 45%;"> <p style="text-align: center;">Calibration Menu</p> <p>T-Stack CO T-Ref B-Smart</p> <p style="text-align: center;">Menu</p> </div> <div style="border: 1px solid black; padding: 5px; width: 45%;"> <p style="text-align: center;">B-Smart</p> <p>Enter Code 00-00-00-00-00 Press ENT</p> <p style="text-align: center;">Menu</p> </div> </div> <hr/> <p> NOTE: If the correct code was entered, the analyzer accepts it and returns to the CALIBRATION MENU. If an incorrect code was entered, the screen will display "Invalid Code." Check to make sure the correct code has been entered. If problem persists, contact your nearest Bacharach Service Provider.</p> <hr/> <p> NOTE: B-SMART® codes can be entered through the Fyrite® User Software (FUS).</p>	



NOTE: Installing a B-SMART® sensor forces the instrument to perform a zero function (either manual or automatic).



NOTE: Bacharach offers a convenient Exchange Program (where available) that allows the customer to regularly receive pre-calibrated replacement sensors that include a code that can be entered into the analyzer for a quick convenient setup. Contact Bacharach customer service for more details about this program.



5.5. T-Stack Calibration

This procedure first zeroes and then spans stack temperature to known temperature values.



The use of an electronic thermocouple simulator is the preferred method of producing the desired calibration temperatures. Alternatively, ice and boiling water baths can be used.

5.5.1. Materials Required

- Thermocouple simulator (K-type)
 - Range: 0 to 600° F (-18 to 316° F)
 - Accuracy: ± 0.5° F (± 0.3° C)
- (Alternatively) ice water, boiling water, thermometer

5.5.2. T-Stack Calibration Procedure

Step	T-STACK Calibration Procedure
1	Plug the simulator into the T-STACK connector located at the bottom of the analyzer. Alternatively: Plug the probe's thermocouple into the T-STACK connector located at the bottom of the analyzer. <hr/> <div style="display: flex; align-items: center;"> <p>IMPORTANT: DO NOT attach the probe's gas hose to the analyzer's GAS port; otherwise water will be drawn into the analyzer!</p> </div> <hr/>
2	If not already done, turn ON the analyzer and display the CALIBRATION Menu. Note that this requires password validation (see page 35).
3	Use the UP (▲) and DOWN (▼) arrow buttons to highlight T-Stack, and then press ENTER to display the CALIBRATE TS-ZERO screen.

Step	T-STACK Calibration Procedure
	<div style="display: flex; justify-content: space-around;"> <div style="border: 1px solid black; padding: 5px; width: 45%;"> <p style="text-align: center;">Calibration Menu</p> <p>T-Stack</p> <p>CO</p> <p>T-Ref</p> <p>B-Smart</p> <p style="text-align: center;">Menu</p> </div> <div style="border: 1px solid black; padding: 5px; width: 45%;"> <p style="text-align: center;">Calibrate TS-Zero</p> <p>Measured: 31 °F</p> <p>Applied: 32.0 °F</p> <p>Press ENT</p> <p style="display: flex; justify-content: space-between;"> Print Reset </p> </div> </div> <p>"Measured" is the current temperature reading. "Applied" is a known temperature that will be applied for calibration purposes.</p>
4	<p>Set thermocouple simulator to 32° F (0° C), and then use the UP (▲), DOWN (▼), LEFT (◀), and RIGHT (▶) arrow buttons to enter an Applied value that exactly equals the setting of the simulator.</p> <p>Alternatively: Submerge probe tip into an ice-water bath with a thermometer, wait several minutes, and then use the UP (▲) and DOWN (▼) arrow buttons to enter an Applied value that exactly equals the thermometer reading.</p> <hr/> <div style="display: flex; align-items: center;">  <p>NOTE: The calibration range is from 32 to 41° F (0 to 5° C). An attempt to calibrate outside this range will cause the message "Applied Value High" (or Low) to appear at the bottom of the screen.</p> </div> <hr/>
5	<p>Wait until the Measured reading stabilizes, and then press ENTER to calibrate the TS-Zero Measured value to that of the Applied value, after which the message "Good Calibration" should briefly appear followed by the CALIBRATE TS-SPAN screen.</p>
6	<div style="border: 1px solid black; padding: 5px; width: fit-content; margin: 0 auto;"> <p style="text-align: center;">Calibrate TS-Span</p> <p>Measured: 570 °F</p> <p>Applied: 572 °F</p> <p>Press ENT</p> <p style="display: flex; justify-content: space-between;"> Print Reset </p> </div> <p>Alternatively: Submerge probe tip into a container of boiling water with a thermometer, wait several minutes, and then use the arrow buttons to enter an Applied value that exactly equals the thermometer reading.</p> <hr/> <div style="display: flex; align-items: center;">  <p>NOTE: The calibration range is from 175 to 625° F (80 to 329° C). An attempt to calibrate outside this range will cause the message "Applied Value High" (or Low) to appear at the bottom of the screen.</p> </div> <hr/>

Step	T-STACK Calibration Procedure
7	Wait until the Measured reading stabilizes, and then press ENTER to calibrate the TS-Span Measured value to that of the “Applied” value, after which the message “Good Calibration” should briefly appear followed by the CALIBRATION menu being re-displayed.



5.6. CO Sensor Calibration

5.6.1. Materials Required

- Calibration kit, P/N 0024-7059
- Gas cylinder: 500 ppm CO in air, P/N 0024-0492

5.6.2. CO Manual Zero Procedure

The CO zeroing process is done automatically during warm-up or manually using the manual zero feature (see page 31). To perform a manual zero, follow the steps below. If your instrument is configured for CO auto zero, then skip this CO manual zero procedure and go to the CO Sensor Span procedure that follows.

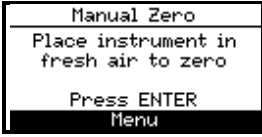
Step	Manual CO Zero Procedure
1	If not already done, turn ON the analyzer and display the Main Menu screen.
2	Use the UP (▲) and DOWN (▼) arrow buttons to select the SETUP menu and press ENTER.
3	From the Setup Menu, use the UP (▲) and DOWN (▼) arrow buttons to select the CO Zero Setting parameter then press ENTER. <div style="display: flex; justify-content: space-around; margin-top: 10px;">   </div>
4	From the CO Zero Setting screen, use the DOWN (▼) arrow button to select the Manual Zero option then press ENTER. A reminder screen to place the instrument in fresh air is displayed. <div style="display: flex; justify-content: space-around; margin-top: 10px;">   </div>
5	Press ENTER and wait for the manual zero to complete.

Step	Manual CO Zero Procedure
	<div style="border: 1px solid black; padding: 10px; width: fit-content; margin: auto;"> <p style="text-align: center;">Setting Manual Zero</p> <p style="text-align: center;">Warm Up: 45</p> </div>

5.6.3. CO Sensor Span Procedure

Step	CO Span Procedure
<p>1</p>	<p>From the Calibration Menu (see page 35), use the UP (▲) and DOWN (▼) arrow buttons to highlight CO, and then press ENTER to display the CALIBRATE CO screen. Note that this requires password validation (see page 35).</p> <div style="display: flex; justify-content: space-around; align-items: center;"> <div style="border: 1px solid black; padding: 5px; text-align: center;"> <p>Calibration Menu</p> <p>T-Stack</p> <p>CO</p> <p>T-Ref</p> <p>B-Smart</p> <p>Menu</p> </div> <div style="border: 1px solid black; padding: 5px; text-align: center;"> <p>Calibrate CO</p> <p>Measured: 0 ppm</p> <p>Applied: 500 ppm</p> <p>Press ENT</p> <p>Print Reset</p> </div> </div> <p>“Measured” is the current CO reading, while “Applied” is a known CO level that will be applied for calibration purposes.</p>
<p>2</p>	<p>Use the UP (▲), DOWN (▼), LEFT (◀), and RIGHT (▶) arrow buttons to enter an Applied value that exactly equals the concentration stamped on the CO cylinder.</p> <hr/> <div style="display: flex; align-items: center;">  <p>NOTE: Bacharach recommends using a 500 ppm calibration gas, however the calibration range is from 20 to 1,000 ppm. An attempt to calibrate outside this range will cause the message “Applied Value High” (or Low) to appear at the bottom of the screen.</p> </div> <hr/>
<p>3</p>	<p>Attach a 500 ppm CO cylinder to the regulator and connect calibration kit components as shown below. Apply 500 ppm carbon monoxide in an air balance calibration gas.</p>
<p>4</p>	<p>Wait until the Measured reading stabilizes and then press ENTER. The message “Good Calibration” should briefly appear.</p> <p>If the sensor’s output is low, but still usable, then the message “Good Calibration WARNING Low Sensor” will appear. The sensor will now be marked as being Low in the Warm-up screen.</p> <p>If the sensor’s output is too low to be usable, then the message “Bad Calibration Sensor End of Life, Entry Not Saved” will appear.</p>
<p>5</p>	<p>Close the regulator and remove the CO cylinder.</p>

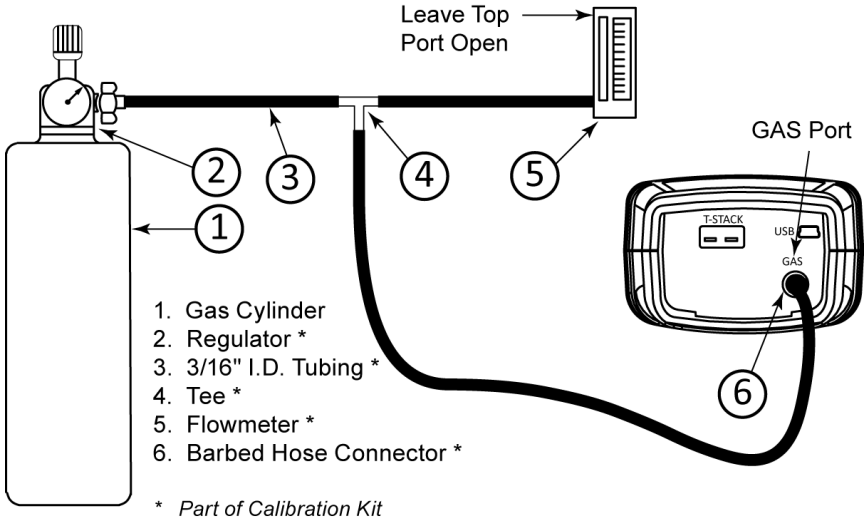

5.7. T-Ref Sensor Calibration

The T-Ref sensor is located inside the instrument. Calibration is done at the factory and should not need to be done in the field.



Section 6. Troubleshooting

6.1. Error and Warning Messages

Message	Description
T-STK Connected	The probe thermocouple is not connected to the analyzer's T-Stack connector. Plug the probe thermocouple plug into the T-Stack connector at the bottom of the instrument.
Check Sensor O ₂	O ₂ sensor output is low, but still usable. Sensor may need to be replaced in the near future. The arrow on the O ₂ Sensor Life screen is in the middle of the last segment on the bar graph.
Replace Sensor O ₂	O ₂ sensor output is low and should be replaced. The arrow on the O ₂ Sensor Life screen is at the end of the last segment on the bar graph (typically 2 years for the O ₂ sensor).
Bad Sensor O ₂	O ₂ sensor output is too low and is not usable, or sensor is missing.
Low Sensor CO	CO sensor output was low but still usable. Sensor may need to be replaced in the near future.
Low Battery	Battery voltage is low. Replace the batteries.
Applied Value High/Low	An attempt was made to calibrate a sensor outside its range—either above (High) or below (Low) the acceptable range.
Warm-up Sensor Error	<ul style="list-style-type: none"> CO sensor was not zeroed at warm-up because of high output. Run instrument on fresh air then restart instrument to re-zero sensor. If the message persists, the CO sensor may need to be replaced. Stack or Air temperature sensors are measuring temperature outside the range of -4° to 212° F at warm-up. Make sure that the Stack and Air thermocouples are sampling ambient room air within the temperature range at warm-up. The Fyrite® InTech® was turned on with the probe sampling flue gas. Move the probe to fresh air and restart the instrument. Messages will indicate which sensors are in error.
Set Clock	<p>Time and date values need to be set in the instrument.</p> <hr/> <div style="display: flex; align-items: center;">  <p>NOTE: If a “set clock” message occurs, then the instrument ignores all O₂-related messages <i>except</i> “Bad Sensor.”</p> </div> <hr/>

Message	Description
X X X	Occurs in the number fields of sensors that have achieved over-range condition.
* * *	Occurs in the number fields of sensors. Replaces in-error sensor values and any calculated values that depend on those sensor values.
- - -	Occurs in the number fields of sensors and indicates that values were not calculated.



NOTE: If a particular sensor is in error during warm-up, the instrument automatically displays the error. The instrument continues to operate with the sensor in error, however information dependent on the sensor in error is not displayed.

6.2. Replacement Parts

Part Number	Description
0024-0788	O ₂ sensor
0204-0004	Battery, AA Alkaline
0024-7265	CO sensor
0024-1504	NO _x filter (Siegert only)
0024-1467	B-Smart® CO sensor
0019-7111	Probe and hose assembly (North America version)
0019-7145	Probe and hose assembly (Siegert version)
0019-3265	Water trap
0007-1644	Filter, pkg. of 3
0024-1579	Replacement End Plate
0024-3073	Replacement Pump Assembly
0024-1620	Battery door/sensor cover
0024-1421	O ₂ Sensor Cap
0024-1484	CO Sensor Cap
0024-1458	CO Sensor Base
0024-9486	Instruction manual
0019-3265	Water trap

6.3. Accessories

Part Number	Optional Accessory
0024-1400	IrDA printer
0024-1310	Printer paper, box of 5 rolls
0021-7006	Smoke kit
0104-1798	Thermocouple (temperature, air), K type (1 inch long)
0104-1797	Thermocouple (temperature, stack), K-type (10 feet long)
0024-7059	CO Calibration kit (no gas)
0024-0492	CO calibration gas, 500 ppm CO
0051-1994	CO calibration gas, 100 ppm CO
0024-1470	PC Software Installer CD
0104-4032	USB cable (A to Mini-B)
0024-1461	Boot , rubber
0024-1505	NO _x filter kit
0024-1492	Reporting kit
0024-0865	Hard carrying case
0019-3037	Probe stop
0024-8555	Optional Appliance Kit for Ambient CO Test

6.4. Instrument Identification

A label on the back of the instrument provides the following information that is useful for service and troubleshooting.

- manufacturer
- country of origin
- certification(s)
- part number
- serial number

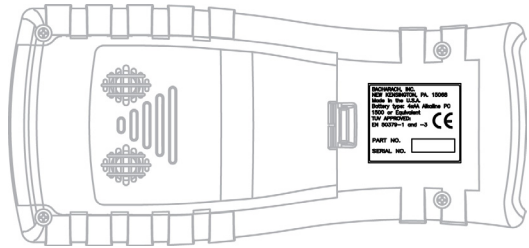

Siegert Label

6.5. Service Centers

Replacement parts and service can be obtained by contacting one of the following Bacharach Service Centers.





CE Declaration of Conformity

The manufacturer of the products covered by this declaration:	Bacharach, Inc. 621 Hunt Valley Circle New Kensington, PA 15068
Year conformity is declared:	2012
Product(s):	Combustion Analyzer
Model(s):	Fyrite [®] InTech [®]

The undersigned hereby declares that the above referenced product is in conformity with the provisions of the following standards and is in accordance with the following directive.

Directive:

2004/108/EC	EMC Directive
-------------	---------------

Standard(s):

EN 50270: 2006	Electromagnetic Compatibility (Immunity): Electrical Apparatus for the Detection and Measurement of Combustible Gases, Toxic Gases, or Oxygen
EN 50379-1 Part 1	General Requirements and Test Methods: Specifications for Portable Electrical Apparatus Designed to Measure Combustion Flue Gas Parameters of Heating Appliances
EN 50379-3 Part 3	Performance Requirements: Performance Requirements for Apparatus Used in Non-Statutory Servicing of Gas-Fired Heating Appliances

Signature:  _____

Name: Doug Keeports
Title: VP of Product Development
Date: November 12, 2012

The technical documentation file required by this directive is maintained at the corporate headquarters of Bacharach, Inc.

